



Collibra Data Intelligence Cloud

Collibra DGC Platform

Collibra Data Governance Center - Collibra Platform

Release date: January 8, 2023

Revision date: Mon Jan 30, 2023

You can find the most up-to-date technical documentation on our Documentation Center at https://productresources.collibra.com/docs/collibra/latest/Content/to_collibra-platform.htm

Contents

Contents	ii
Basic features	1
Collibra DGC functionalities	2
Prerequisites	24
Steps	24
Steps	40
Steps	42
Steps	43
Wrap the text of an individual cell	44
Wrap the text of all cells	44
Add columns to a table	45
Steps	45
Show responsibilities in an asset table	46
Steps	46
Edit the column order	47
Steps	47
Edit a column name	48
Steps	48
Remove columns from a table	49
Remove columns from the Table Columns dialog box	49
Remove columns from the Select Columns dialog box	49
Change the number of rows per page	51
Steps	51

Freeze columns	52
Steps	52
Steps	52
Steps	53
Apply a column filter	56
Steps	56
Clear a column filter	57
Steps	57
Enable or disable hierarchies	61
Steps	61
Steps	64
Add fields to a set of tiles	66
Steps	66
Show responsibilities in a tile set	67
Steps	67
Edit the order of the fields	68
Steps	68
Edit a field name	69
Steps	69
Remove fields from a set of tiles	70
Remove fields using the Fields dialog box	70
Remove fields using the Select fields dialog box	70
Edit the number of tiles per page	71
Steps	71
Steps	71
Sort a set of tiles	73

Steps	73
Steps	74
Asset functionalities	109
Importing and exporting	208
Diagrams	225
Via the diagram editor	295
Via the JSON text editor	295
Tips	335
Data modeling	383
Collibra DGC building blocks	384
Asset types	400
Assignments	452
Overview of characteristic types	468
Domain types	511
Asset statuses	518
Articulation score	525
Asset data quality	535
Validation rules	544
Scopes	582
Workflows	588
Contents	592
The Reporting Data Layer	597
Working with your reporting data	597
Dashboard reports	600
Reporting Data Layer tables	604
Creating the Reporting Data Layer on AWS and generating reports	606

Creating the Reporting Data Layer on GCP and generating reports	637
Improving the visual output of the Data Maturity report	675
Reporting Data Layer entity relationship diagram	685
Remove non-applicable regulation placeholder from Privacy & Risk Readiness report	702
Dashboards	704
Permissions	704
Create a dashboard	705
Copy a dashboard	706
Edit the properties of a dashboard	707
Switch to another dashboard	708
Share a dashboard	708
Delete a dashboard	708
Dashboard widgets	709
Add a widget to a dashboard	733
Move a widget	733
Edit a widget	734
Delete a widget from a dashboard	735
Data Helpdesk	737
Data Helpdesk submenu pages	737
Packaged metamodel for the Data Helpdesk	738
Issue roles	740
Create a data issue	741
Create issue: options	743
Tasks in the Issue Management workflow	744
Metrics pages	751
Data Stewardship	767

Data Stewardship submenu pages	767
Using workflows	769
Start a global workflow	770
Start an asset workflow from an asset page	770
Start an asset workflow from an asset table or set of tiles	770
My Tasks page	771
Viewing workflow tasks	773
Working with tasks	774
Collibra DGC settings	779
General settings page	780
Operating model settings page	788
Roles and permissions settings page	789
Managing workflows in Collibra DGC	823
Users and groups settings page	847
Services configuration	887
Migration	931
Replace the Collibra logo	1032
Use a custom favicon	1034

Basic features

In this section, we describe the various basic features to make you familiar with your Collibra Data Governance Center environment. You learn where you can find everything in the user interface, how to find data, what kind of data exists in your environment and other basic manipulations.



Collibra DGC functionalities

In this section, you find more information about the general functionalities of Collibra Data Governance Center such as searching for data, using dashboards and the global Create button.

In this chapter

Screen elements in the user interface

The Collibra Data Governance Center user interface contains a number of common elements that appear throughout the product.







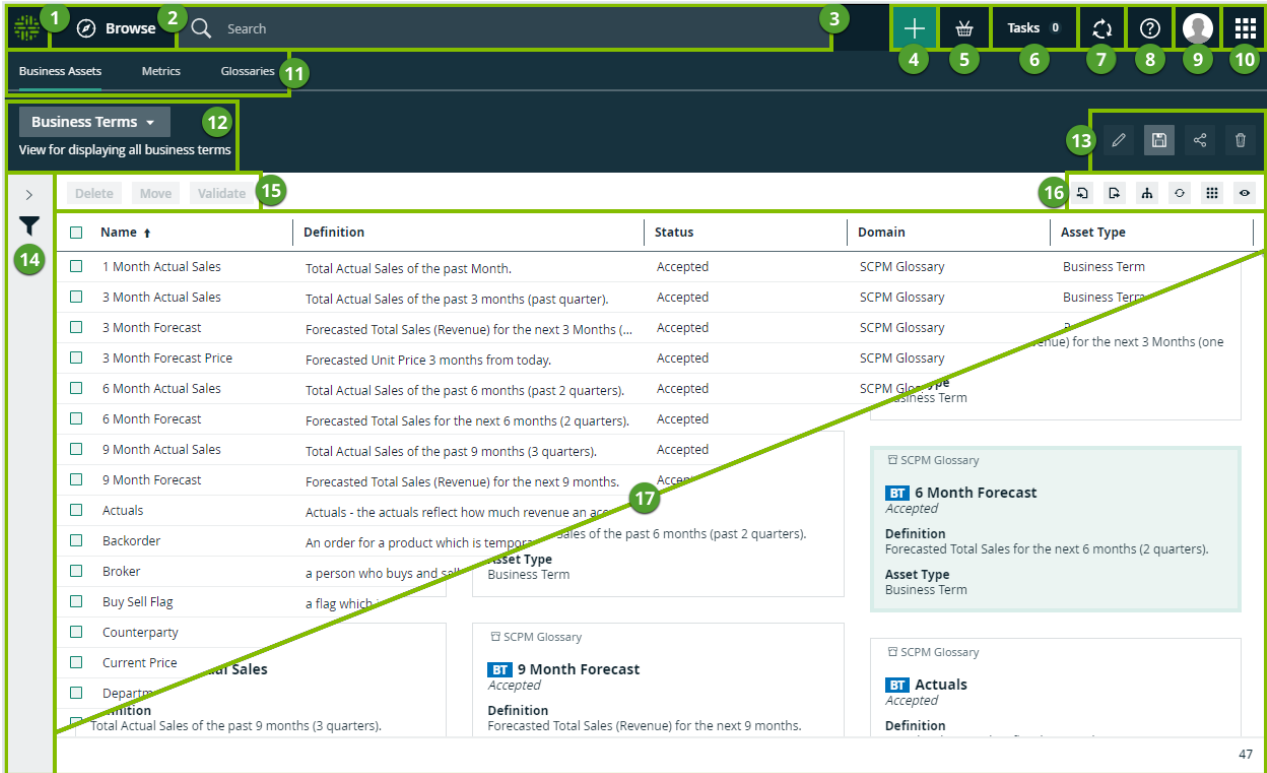

You can navigate through Collibra Data Governance Center using your mouse or keyboard. For more information, see [Accessibility](#).



Page layout



No.	Element name	Description
1	Home button	Open your default dashboard .
2	Navigation browser	Open the navigation browser.
3	Search field	Search for any resource in Collibra DGC.
4	+ button	Create any resource from any location.
5	Shopping basket	Request access to data sets and reports.
6	Tasks indicator	See how many workflow tasks are awaiting your attention and manage those tasks from a the My tasks page.

No.	Element name	Description
7	Activities tracker	Check Collibra DGC activities and see the history of all the jobs you started.
8	Info	Get access to the product documentation, to Collibra Product Resource Center and University and to the Collibra support portal. <div style="border: 1px solid #ccc; background-color: #f9f9f9; padding: 10px; margin-top: 10px;"> <p>Note If you have the Sysadmin role, you also have direct link to the API documentation.</p> </div>
9	Avatar	View and modify your profile , sign out, and report a problem.
10	Application menu	Open another application: <ul style="list-style-type: none"> •  Business Glossary: Manage your business terms. •  Catalog: Manage data sets. •  Policy manager: Manage your organization's policies. •  Reference Data: Manage your code values and code sets. •  Global view: See all assets in a single view. •  Data Helpdesk: Manage issues. •  Stewardship: Manage your tasks. •  Settings: Manage your data governance operating model and your users.
11	Submenu	Open one of the subpages of the current application.
12	View selector	Switch between views .
13	View toolbar	Manage the current view .
14	Filter pane	Filter the resources in the view.

No.	Element name	Description
15	Action toolbar	Perform actions on the assets that you selected in the view or start a workflow .
16	Content toolbar	Manage the resources in the current view.
17	Table or set of tiles	See the resources in the current view in a table or as tiles .

Arranging list items

On some pages and in some dialog boxes, you can arrange list items to change the order of their appearance on the page. For example when adding fields to a view or editing an asset type assignment.

Example

You can have arrangeable lists in dialog boxes and on regular pages. You can arrange the list items in the same way.

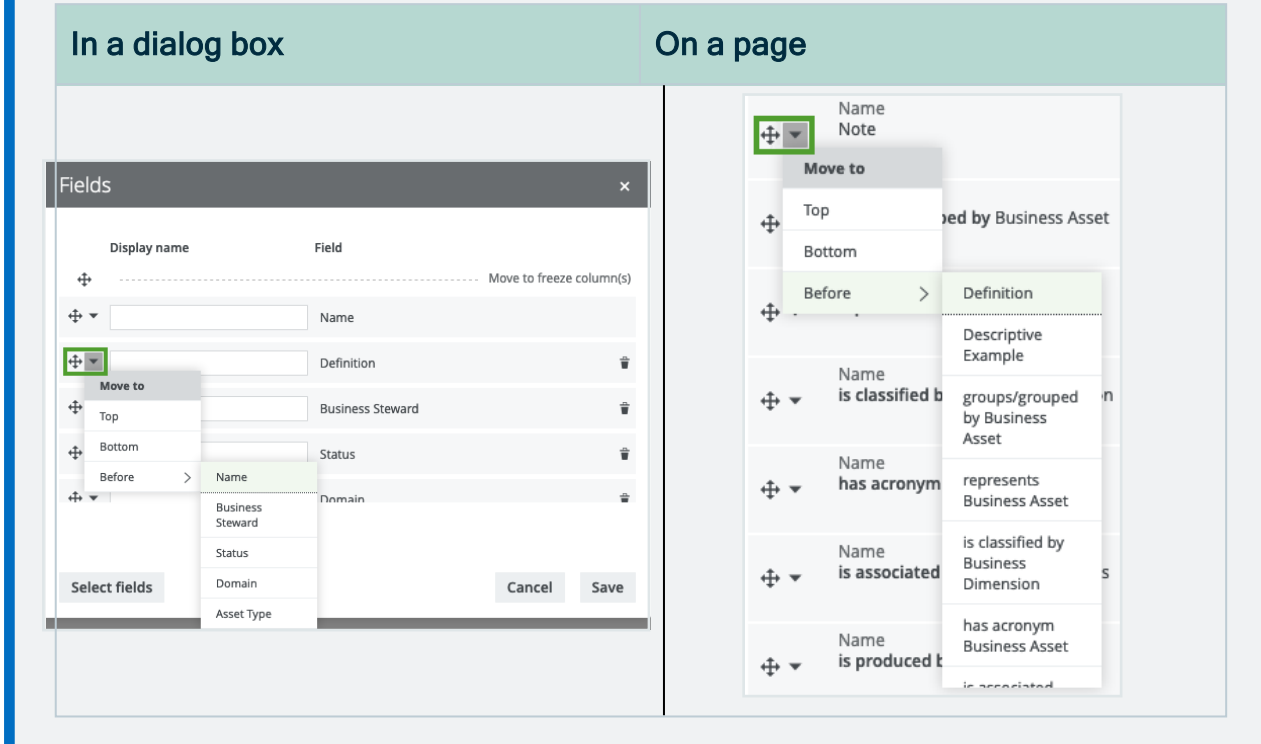

Moving items by dragging and dropping

The easiest way to move items up or down is typically by dragging and dropping:

1. Click  in front of an item and hold down the mouse button.
2. Move your mouse to the desired location in the order.
3. Release the mouse button.

Moving items via the drop-down menu

Each item also has a drop-down menu that allows you to quickly change the position of the item in the list:

1. Click ▼ in front of an item.
2. Do one of the following:
 - Click **Top** to move the item to the top of the list.
 - Click **Bottom** to move the item to the bottom of the list.
 - Point to **Before** and click an item in the list to move the current item to the position above the clicked item.

Accessibility







In an effort to make all Collibra applications accessible for visually or physically impaired users, all applications are gradually being upgraded to meet accessibility requirements as set out in the [Section 508 Standards](#) (US) and [WCAG 2.0](#) (Worldwide).

Collibra has taken measures to ensure accessibility, for example:

- Icons and text have sufficient contrast with the background.
- Images have clear alternative text to facilitate the use of third-party assistive technology.
- Navigation on our pages is enhanced, for example, you can open a link in a new tab.
- You can [navigate](#) through most screen sections by keyboard.
- You can [edit](#) interface text to make messages less dependent on visual screen elements.

Navigating using your keyboard

As part of the accessibility goals of Collibra, you can navigate using your keyboard.

Action	Description									
Moving the focus point	<p>The focus point indicates the current focus of your navigation. If you hover your mouse pointer over an element, you typically see the background change, or text becomes underlined.</p> <p>When you use the keyboard, the same effect takes place as when you hover your mouse pointer. However, rather than moving your mouse, you can jump to the next element using the tab key on your keyboard. You can also press shift + tab to jump to the previous element.</p> <p>Example</p> <table border="1"> <thead> <tr> <th>Type</th> <th>Unfocused element</th> <th>Focused element</th> </tr> </thead> <tbody> <tr> <td>Button</td> <td></td> <td></td> </tr> <tr> <td>Link</td> <td>Customer account <input type="checkbox"/> New Data Dictionary</td> <td>Customer account <input type="checkbox"/> <u>New Data Dictionary</u></td> </tr> </tbody> </table>	Type	Unfocused element	Focused element	Button			Link	Customer account <input type="checkbox"/> New Data Dictionary	Customer account <input type="checkbox"/> <u>New Data Dictionary</u>
Type	Unfocused element	Focused element								
Button										
Link	Customer account <input type="checkbox"/> New Data Dictionary	Customer account <input type="checkbox"/> <u>New Data Dictionary</u>								
Clicking and activating screen elements	Press enter to activate an element when it is the focus point. This allows you to press a button or open a link, using your keyboard rather than clicking.									
Opening and closing dialog boxes and pop-ups	Click any dialog box or pop-up to open it. You can navigate in the dialog boxes and pop-ups just as you would anywhere else. To close it, press escape .									
Selecting and clearing checkboxes	Navigate to a checkbox and press the space bar to select it or clear it.									

Action	Description
Selecting radio buttons	Use the arrow keys on your keyboard to select radio buttons. Navigate to the radio buttons using the tab key, then press ←, →, ↓ or ↑ to change which radio button is selected.
Skipping repetitive sections	<p>Most pages in Collibra Data Governance Center contain repetitive sections at the top of the page, such as the main menu. You can skip this section using the Skip to content button.</p> <p>This button is the first available element when you start navigating in a repetitive section using your keyboard.</p> 

Signing in and signing out

As soon as you have a user account, you can sign in to Collibra Data Governance Center.

Sign in

1. Go to any page of your environment.» The Sign-in page opens.
2. Enter your username and password.

3. If a **disclaimer is enabled**, you have to agree with the disclaimer to sign in. If you don't agree with the disclaimer, you are signed out automatically.

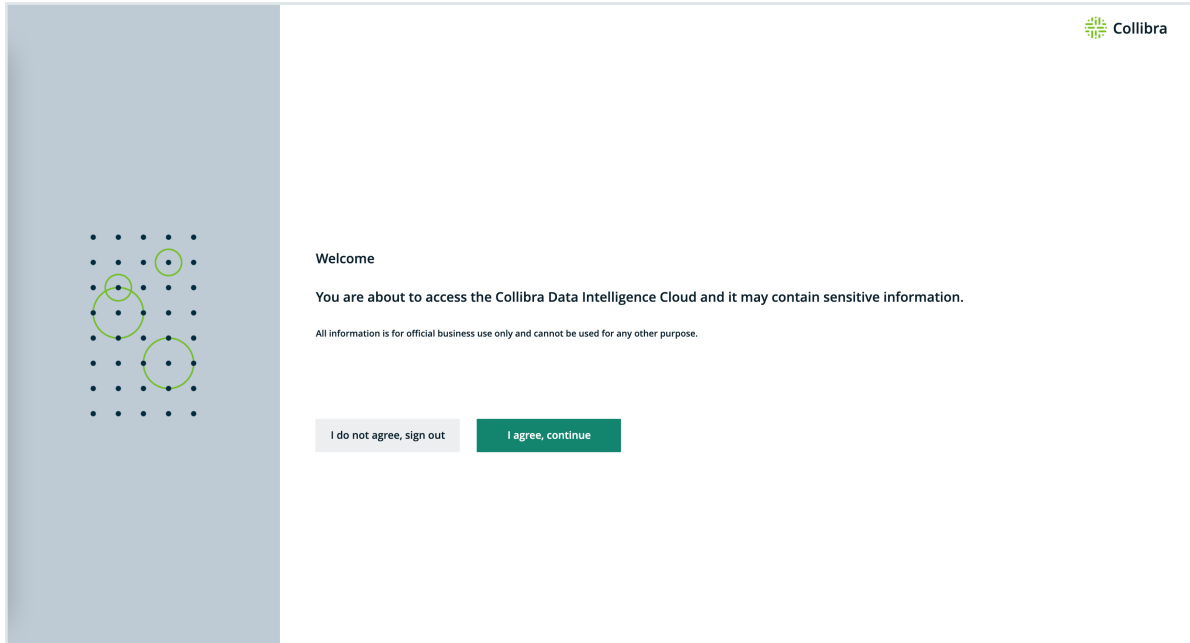

Tip

- If Single Sign-On (SSO) is configured for your environment, you can be signed in automatically if you are signed in to the SSO system.
- By default, the username is case-sensitive. However, some LDAP configurations make the username not case sensitive.

Sign out

1. Click your avatar, then **Sign out**.
 - » The Sign-in page opens.

Note Depending on your environment's configuration, you may be signed out automatically if you are inactive for a certain period of time. Most of the changes you have made during your session will be saved. However, if you had a text field or dialog box open when you were signed out, that information may be lost.

Navigating through domains and communities

The **Browse** pane provides an overview of all communities and domains.

To navigate through the communities and domains, click  **Browse** in the main menu.

Initially, the browser only shows the top-level communities. To see the community's sub-communities and domains, click  in front of the community name.

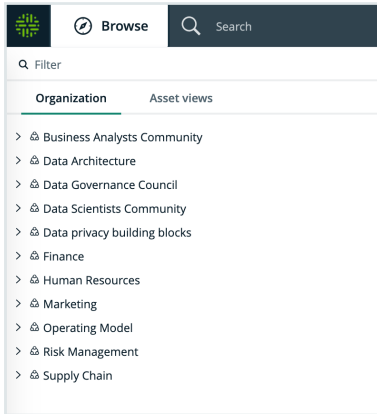

Start typing in the **Search in Organization** field to search for a community or domain.

When you click a community or domain name, you navigate to the corresponding community or domain page. This page shows all details and allows you to make changes.

The Create button

In Collibra Data Governance Center, there is a green **Create** button at the top of the screen. It enables you to create any resource from any location, if you have the correct permissions.



The following table describes the categories of resources you can create with the **Create** button:

Item	Description
Suggested	<p>A list of resources that you might want to create.</p> <p>The resources available to you here depend on your location in Collibra DGC:</p> <ul style="list-style-type: none"> • If you are on one of the submenu pages, for example, Business assets, Metrics or Glossaries, the suggested resources are specific to that submenu page. • If you are on a domain page, the suggested resources are all the asset types that are assigned to the domain. • If you are on a community page, the suggested resources are all the asset types that are assigned to the domains in the community. • If you are on an asset page, the suggested resource is an asset of that same type. <p>This list is not available when you click the Create button from the default dashboard.</p>
Recent	A list of recently created resources, most recent first.
Actions	A list of global workflows that have the option Show in global create enabled.
Asset	A list of all the asset types that are available in your data governance model. The list is divided into sections, according to the parent asset type, for example, Business Asset or Data Asset.
Organization	A list of organizational resources, such as a Community or a Business Asset Domain.

To quickly find what you are looking for, you can type a search term in the **Filter** field. The results are based on the category you selected.

Note You can only create assets of a certain type in a certain domain if that asset type has been assigned to that domain.

If you try to create an asset of a type that is not assigned to the domain you are currently in, the **Domain** field in the **Create** dialog box is not automatically filled in.

Views in Collibra DGC

Views in Collibra Data Governance Center define how you can look at lists of assets. You can configure views to see, for example, tables or a set of tiles. A view is also the basis for [Importing and exporting](#).

While you are working with a view, Collibra DGC stores your view configuration when you navigate to a different page and even when you sign out. You can also undo your changes.

Views

A view defines a table or set of tiles by storing the following data:

- The **display mode**, to specify whether assets are shown in a table or as tiles.
- Filters, to specify which assets are displayed.
- Applied sorting, to specify the order of the assets.
- Visible columns (for tables) or fields (for tiles), to specify which information about assets is displayed.
- Hierarchy, to display, optionally, a hierarchy of assets instead of a flat list (not applicable in tile display mode).

Tip You can create as many views as you want without causing problems for Collibra DGC's performance.

A view is also the basis for [Importing and exporting](#).

Example of a view in table display mode:

Name	Definition	Business Steward	Status	Domain	Asset Type
1 Month Actual Sales	Total Actual Sales of the past ...	John Fisher	Accepted	SCPM Glossary	Business Term
3 Month Actual Sales	Total Actual Sales of the past 3...	John Fisher	Accepted	SCPM Glossary	Business Term
3 Month Forecast	Forecasted Total Sales (Reven...	John Fisher	Accepted	SCPM Glossary	Business Term
3 Month Forecast Price	Forecasted Unit Price 3 month...	John Fisher	Accepted	SCPM Glossary	Business Term
6 Month Actual Sales	Total Actual Sales of the past 6...	John Fisher	Accepted	SCPM Glossary	Business Term
6 Month Forecast	Forecasted Total Sales for the ...	John Fisher	Accepted	SCPM Glossary	Business Term
9 Month Actual Sales	Total Actual Sales of the past 9...	John Fisher	Accepted	SCPM Glossary	Business Term
9 Month Forecast	Forecasted Total Sales (Reven...	John Fisher	Accepted	SCPM Glossary	Business Term
Actuals	Actuals - the actuals reflect ho...	John Fisher	Accepted	SCPM Glossary	Business Term
Backorder	An order for a product which is t		Accepted	SCPM Glossary	Business Term
Broker	a person who buys and sells g...		Candidate	Trading Glossary	Business Term

Example of a view in tile display mode:

Term Name	Status	Definition	Business Steward	Asset Type
BT 1 Month Actual Sales	Accepted	Total Actual Sales of the past Month.	John Fisher	Business Term
BT 3 Month Actual Sales	Accepted	Total Actual Sales of the past 3 months (past quarter).	John Fisher	Business Term
BT 3 Month Forecast	Accepted	Forecasted Total Sales (Revenue) for the next 3 Months (one quarter).	John Fisher	Business Term
BT 3 Month Forecast Price	Accepted	Forecasted Unit Price 3 months from today.		Business Term
BT 6 Month Actual Sales	Accepted	Total Actual Sales of the past 6 months (past 2 quarters).		Business Term
BT 6 Month Forecast	Accepted	Forecasted Total Sales for the next 6 months (2 quarters).		Business Term

When you view a table or set of tiles for the first time, you are using the Collibra DGC default view, unless somebody already shared a custom view as default with you.

Each view has a unique URL. You can use this URL to open the view directly, without having to navigate to the location. For example, you can embed the view URL in a text

widget on a dashboard, in an email and so on. You can simply copy the URL from the address bar and paste it where needed.

View types

Collibra offers different types of views:

- [Dashboards](#)
- [Search filters](#)
- [Diagram views](#)
- [Relation views](#) on an asset page
- Asset views, for example in a [domain](#) or [community](#), in the [global view](#) and in application views.

Asset views are available in the following applications:

Application	Tabs with a view selector
Business Glossary	<ul style="list-style-type: none"> • Business Assets • Glossaries
Reference Data	<ul style="list-style-type: none"> • Code Values/Sets • Hierarchies
Data Catalog	<ul style="list-style-type: none"> • Reports • Data Sets • Data Dictionary • Technology Assets
Data Helpdesk	<ul style="list-style-type: none"> • Issues • Data Quality
Data Stewardship	Business Dimensions
Policy Manager	Governance Assets

View selector and toolbar

The view selector allows you to switch between views and the view toolbar to manage the currently selected [view](#).

It appears in views containing a [table](#) or a [set of tiles](#).



The view bar has the following items:



Number	Button	Description
1	n/a	The view selector shows the name and description of the current view, and allows you to choose another view.
2		Button to edit the name and the description of the current view.
3		Button to save changes to the current view, or to create a new view.
4		Button to share the current view.
5		Button to delete the current view.

Create a view

You can create a [view](#), for example, if you want it to contain specific fields and display assets based on a filter.

Tip You can create as many views as you want without causing problems for Collibra DGC's performance.

Steps

1. Navigate to the set of assets (in table [display modes](#) or tile display mode) for which you want to create a view.
Example: Business Glossary
If you want to start from the configuration of an existing view, [switch](#) to that view.
2. Set the required [filters](#).
3. [Customize the table](#) or [customize the set of tiles](#).
4. Optionally, [enable hierarchy](#) or [wrap text](#) (not applicable in tiles display mode).
5. On the right side of the view bar, click .
6. In the view toolbar, click , then **Save as**.
» The **Save view as** dialog box appears.
7. Enter the required information.

Option	Description
Name	The name of the new view.
Description	Optional. The description of the new view. You can add extra information about the view if necessary.
View sharing options	The sharing options allow you to share the view: <ul style="list-style-type: none"> ◦ Public: All Collibra Data Governance Center users can use the new view. ◦ Private: Only the creator of the view can use the new view. ◦ Share with specific roles, groups & users: The users with whom you want to share the new view. You can select Roles, Groups and Users.
Promote view	You can promote the view by pinning it to the view or making it the default view: <ul style="list-style-type: none"> ◦ Default: The new view becomes the default view when you open the table or set of tiles. ◦ Pin: The view is pinned to the view selector.

8. Click **Save**.

Edit a view

You can edit a [view](#), for example, if you want it to change its name.

Steps

1. Navigate to the set of assets (in table [display mode](#) or tile display mode) for which you want to edit a view.
Example: Business Glossary
2. [Switch](#) to the view that you want to edit.
3. In the view toolbar, click  .
» The **Edit name & description** dialog box appears.
4. Enter the required information.

Option	Description
Name	The name of the new view.
Description	Optional. The description of the new view. You can add extra information about the view if necessary.

5. Click **Save**.

Edit a view's configuration

You can edit a [view](#), for example, if you want it to change its fields and filters.

Steps

1. Navigate to the set of assets (in table [display mode](#) or tile display mode) for which you want to edit a view.
Example: Business Glossary
2. [Switch](#) to the view that you want to edit.
3. If required, do the following:
 - Edit the view's [filters](#).
 - [Customize the table](#) or [customize the set of tiles](#).

- Enable hierarchy or wrap text.
4. In the view toolbar, click , then **Save**.

Share a view

You can share a [view](#), for example, if you want to give other users access to it.

Steps

1. Navigate to the set of assets (in table [display mode](#) or tile display mode) for which you want to edit a view.
Example: Business Glossary
2. [Switch](#) to the view that you want to edit.
3. On the right side of the view bar, click .
 - » The **Share view** dialog box appears.
4. Enter the required information.

Option	Description
View sharing options	<p>The sharing options allow you to share the view:</p> <ul style="list-style-type: none"> ◦ Public: All Collibra Data Governance Center users can use the new view. ◦ Private: Only the creator of the view can use the new view. ◦ Share with specific roles, groups & users: The users with whom you want to share the new view. You can select Roles, Groups and Users.
Promote view	<p>You can promote the view by pinning it to the view or making it the default view:</p> <ul style="list-style-type: none"> ◦ Default: The new view becomes the default view when you open the table or set of tiles. ◦ Pin: The view is pinned to the view selector.

5. Click **Save**.

Delete a view

You can delete a [view](#), for example, if you no longer need it.

You can delete a view in several ways:

- From the view bar.
- From the overview.

Delete a view from the view bar

1. Navigate to the set of assets (in table [display mode](#) or tile display mode) for which you want to delete a view.
Example: Business Glossary
2. [Switch](#) to the view that you want to delete.
3. In the view toolbar, click  .
 - » The **Delete view <view name>** dialog box appears.
4. Click **Delete view**.

Delete a view from the overview

1. Navigate to the set of assets (in table [display mode](#) or tile display mode) for which you want to delete a view.
Example: Business Glossary
2. In the view selector, click  , then **Show all**.

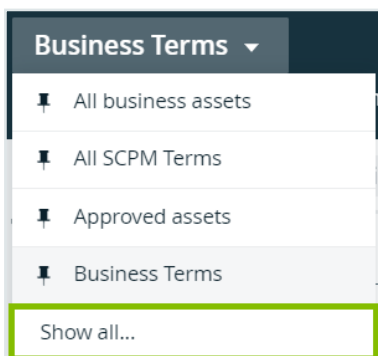

3. In the table, click  at the end of the row of the view you want to delete.
 - » The **Delete view <view name>** dialog box appears.
4. Click **Delete view**.

Pin a view to the view selector

You can pin a [view](#) to the view selector if you want to make it easier to open it.

Steps

1. Navigate to the set of assets (in table [display mode](#) or tile display mode) for which you want to edit a view.

Example: Business Glossary

2. Click the view selector, then **Show all...**

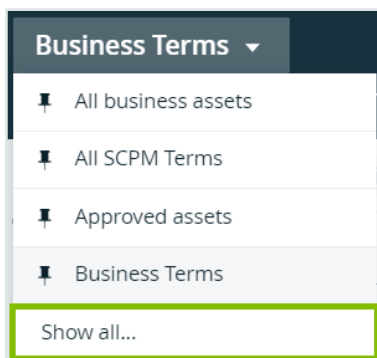

3. In the views table, click the thumbtack (📌) to the left of the views you want to pin or unpin.

Business Assets views

[< Return to current view](#)

My Views only

📌	Name ↑	Description
📌	Acronyms	View for displaying all acronyms
📌	All business assets	View for displaying all business assets
📌	All SCPM Terms	View for displaying all business terms for...
📌	Approved assets	View for displaying all approved assets
📌	Business Terms	View for displaying all business terms
📌	In Progress	View for displaying all assets with status '...

Switch between views

You can switch between [views](#), for example, if you want to see the information of another view.

Steps

1. Navigate to the set of assets (in table [display mode](#) or tile display mode) for which you want to edit a view.

Example: Business Glossary

2. In the view selector, click ▼ next to the name of the current view.
3. Do one of the following:

If...	then...
The view you want to display is in the list,	Click the view in the drop-down menu.
The view you want to display is not in the list,	<ol style="list-style-type: none"> a. Click Show all. b. Click the name of the view you want to display.



Global views

Global views enable you to show all assets of Collibra Data Governance Center in one view, regardless of their community, domain or application.

You can use all view features, such as:

- Change the [display mode](#) to table or tiles.
- [Create](#) views with different fields and filters.
- [Import and export](#) the assets or complex relations in the view.

Open a global view

1. In the main menu, click , then  **Global view**.
2. If required, [switch](#) to another view.

Timeout period for the loading of tables and tiles

In some cases, the loading of a table or set of tiles can take a while. This can happen if the view contains a lot of data, or if it has complex sorting and filtering applied. The timeout period is a time limit (in seconds) after which the loading task is stopped and a timeout error is shown.

If the timeout period expires before the view has loaded, you can try refreshing the view or, if applicable, simplifying its configuration by:

- Removing [basic](#) or [advanced](#) asset filters.
- [Removing](#) the sorting on multiple columns (tables only).
- Reducing the [row count](#) or [tiles count](#).
- Reducing the number of [columns](#) (in a table) or [fields](#) (in a set of tiles).

You can [configure the maximum loading time of tables](#).

Configure the maximum loading time of tables

In some cases, the loading of a table or set of tiles can take a while. You can configure the maximum loading time.

Note Depending on your environment, you have to follow this procedure either in the [Services Configuration](#) section of the [Collibra DGC settings](#) or in Collibra Console. This topic shows the procedure in Collibra Console. If your Settings page has a **Configuration** tab, you can follow this procedure in that tab page. For more information, see the [online documentation](#).

Prerequisites

- You have the ADMIN or SUPER role in Collibra Console.
- You have the SUPER role in Collibra Console.

Steps

1. Open the DGC service settings for editing:
 - a. Open Collibra Console.
 - » Collibra Console opens with the **Infrastructure** page.
 - b. In the tab pane, expand an environment to show its services.
 - c. In the tab pane, click the Data Governance Center service of that environment.
 - d. Click **Configuration**.
 - e. Click **Edit configuration**.
2. Go to the **Data Classification** section.

3. Enter the required information:

Setting	Description
Time limit for loading data in tables in seconds	<p>Enter the maximum amount of seconds to load a table. If this time is exceeded, a timeout error is displayed.</p> <p>The default value is 60.</p> <p>A value of 0 means that there is no time limit.</p>

4. Click the green **Save all** button.

Asset filters

Asset filters enable you to quickly find the data in Collibra Data Governance Center by limiting the amount of assets shown in a table or a set of tiles. You can find the filter function on almost every page containing data.

In this section, you can learn how to work with filters.

Basic and advanced filtering

Collibra Data Governance Center has two modes for filtering data:

- **Basic:** Filter data by creating simple filter expressions that are always combined by the logical AND function.
- **Advanced:** Filter data by creating complex filter expressions. An advanced filter is a combination of filter expressions that can be combined by using the logical AND and OR functions.

In the filter pane, you can toggle between basic and advanced filtering:

Basic filtering:

Advanced filtering:

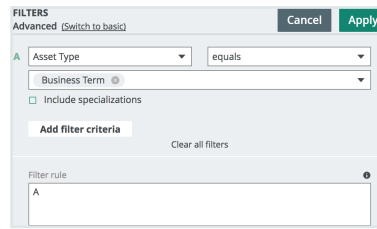
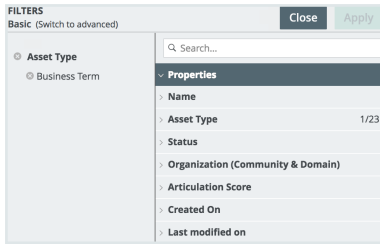

When you have applied a filter, you can save the view for later usage.

Basic filters

You can create basic filters by adding filter expressions. A filter expression is created by selecting a characteristic and assigning one or more values to it. In a basic filter, you can combine multiple expressions.

The characteristics are grouped in the following categories:

- **Properties:** All the asset properties in Collibra DGC such as name, asset type, tags and so on.
- **Attributes:** All the asset attributes in Collibra DGC, such as note, definition, quality and so on.
- **Relations:** All the relations in Collibra DGC.
- **Roles:** All the resource roles that are defined in Collibra DGC, such as Requester, Assignee, Reviewer and so on.



To add characteristics to the filter, consult [Create a basic filter](#).

Filter behavior

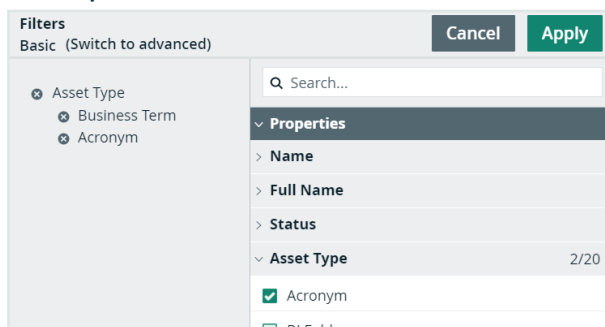
- Multiple values for one characteristic are treated as an OR clause.
 - Example:



The example filters the assets if the asset type is Acronym or Business Term.

- All the simple expressions in a basic filter are treated as an AND clause.
- You can remove a filter characteristic by clicking  next to the filter characteristic that you want to delete, or you can remove a single value from a filter characteristic by clicking  next to its value.

Other filter aspects

- If you use filters in hierarchy views (not available in tile display mode), Collibra DGC only applies the filter at the 'root' (start) level of the hierarchy. Child rows are not filtered.
- In the **Roles** category of the filter characteristics, you can select one or more specific users or user groups, or *current user* to filter on the signed-in user. This has the advantage that it is not necessary to create a filter for every single user.
 - Example: Filter assets by "current user" with Reviewer responsibility: If user A is signed in, the table shows the assets for which User A has Reviewer responsibility. If user B is signed in, the table shows the assets for which User B has Reviewer responsibility.
- The **Roles** category of a basic filter does not take into account inherited responsibilities. If you want to include inherited responsibilities in the filter criteria, you can use an [advanced filter](#).

Create a basic filter

If you want to customize a view to make sure that you only see the assets that you really need, you can create a filter.

To create a basic filter, follow these steps:

1. Navigate to a table or set of tiles that contains the assets you want to see.
Example: Business Glossary
2. In the **Filters** pane, next to filters, click **Edit**.

Verify that you are in basic filter mode. If you aren't, click **Switch to basic**.

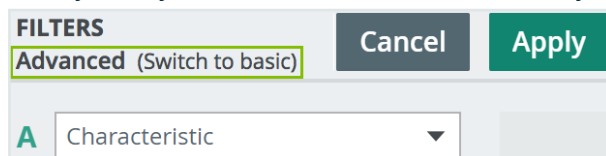

3. In the right column of the **Filters** pane, select the characteristics that you want to include in your filter.

You can do this in different ways:

- By typing the name of what you are looking for in the search field at the top, and then selecting the characteristic.

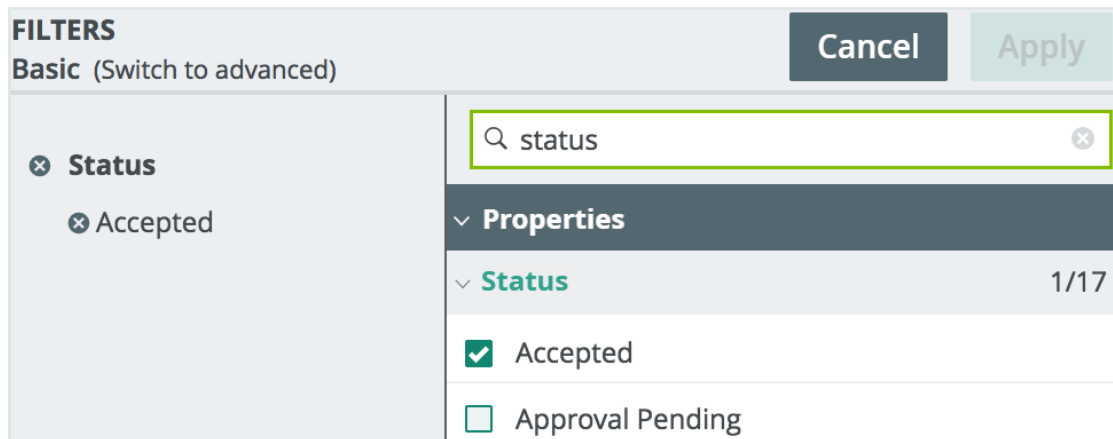

- By going through the list while expanding or collapsing characteristics to find what you are looking for, and then selecting the values.

FILTERS Cancel Apply

Basic (Switch to advanced)

⊗ **Asset Type**

⊗ Attribute

🔍 Search...

∨ **Properties**

> **Name**

∨ **Asset Type** 1/23

Acronym

Attribute

> **Status**

> **Organization (Community & Domain)**

> **Articulation Score**

> **Created On**

> **Last modified on**

> **Tags**

∨ **Attributes**

> **Abbreviation**

> **Data Source**

> **Data Type Precision**

Note

- For some characteristics, you have to select the values from a predefined list, for example *Type* or *Status*.
- For some characteristics, you have to type one or more values, for example *Name* or *Definition*.
- Multiple values for a characteristic are treated as an OR clause.
- All the simple expressions in a basic filter are treated as an AND clause.
- You can remove a filter characteristic by clicking **✕** next to the filter characteristic that you want to delete, or you can remove a single value from a filter characteristic by clicking **✕** next to its value.

4. Click **Apply** to activate the filter or click **Cancel** to close the filter characteristics pane.

Advanced filters

Advanced filters are like basic filters in that they consist of one or more filter clauses. Advanced filters, however, use advanced logical operators. In a basic filter clause, the logical operator is "equals". In advanced filter clauses, the operator depends on the property, characteristic or resource role that you select as the filter criterion.

The filter criteria are grouped as follows:

- **Properties:** All the asset properties in Collibra DGC, for example name, asset type and tags.
- **Attributes:** All the asset attributes in Collibra DGC, for example note, definition and quality.
- **Relations:** All the relations in Collibra DGC.
- **Roles:** All the resource roles that are defined in Collibra DGC, for example Business Steward, Requester and Assignee.

The following table shows some examples of operators, per filter criterion type:

Filter criterion type	Operators
Text, for example <i>Name</i>	<ul style="list-style-type: none"> • equals • does not equal • contains • does not contain • starts with • does not start with • ends with • does not end with • exists • does not exist
Boolean, for example <i>Certified</i>	<ul style="list-style-type: none"> • equals • does not equal • exists • does not exist
Numeric, for example <i>Articulation Score</i>	<ul style="list-style-type: none"> • equals • does not equal • less than • less than or equals • greater than • greater than or equals
Date, for example <i>Created On</i>	<ul style="list-style-type: none"> • equals • before • before or equal to • after • after or equal to • last (...) days • exists • does not exist

Filter criterion type	Operators
Resource role, for example <i>Business Steward</i>	<ul style="list-style-type: none"> • contains • does not contain • equals • does not equal • starts with • does not start with • ends with • does not end with • exists • does not exist <div style="border: 1px solid #ccc; padding: 10px; margin-top: 10px;"> <p>Note If you select the logical operator "equals", you can select the value Current User, to find all assets for which you have been assigned the specified resource role. This means that users might see different results in the same view, depending on their responsibilities.</p> </div> <p>Filtering by resource role and a specific user is extended to user groups that include the specified user, for the selected resource role.</p> <div style="border: 1px solid #ccc; padding: 10px; margin-top: 10px;"> <p>Example John Fisher is included in a user group named The Dream Team. There are a number of assets for which The Dream Team user group has been assigned as the Business Steward. If you filter a view by Business Steward, and specify the user John Fisher, all such assets will pass the filter.</p> </div>

You can create a combination of clauses by using the AND and OR operators and brackets. The order of the clauses does not affect the results.

Depending on the logical operator, you can add multiple values. If you do so, the values are treated as an OR operator.

Example The filter below finds assets that meet these criteria: they have the asset type *Business Term* OR the assets have both the domain *Business Glossary* and one of these three statuses: *Accepted*, *Approval Pending* or *Candidate*.

The screenshot shows the 'Filters' pane in 'Advanced' mode. It contains three filter clauses labeled A, B, and C. Clause A: 'Asset Type' dropdown set to 'Business Term', operator 'equals', and value 'Business Term'. Clause B: 'Domain' dropdown set to 'New Business Terms', operator 'equals', and value 'New Business Terms'. Clause C: 'Status' dropdown set to 'Accepted', operator 'equals', and values 'Accepted', 'Approval Pending', and 'Candidate'. The filter rule is 'A OR (B AND C)'. Buttons for 'Cancel', 'Apply', 'Add filter criteria', and 'Clear all filters' are visible.

Create an advanced filter

You can create an advanced filter to only see the assets that you need in your view.

Steps

1. Navigate to a table or set of tiles that contains the assets you want to see.
Example: Glossary
2. In the **Filters** pane, next to Filters, click **Edit**.
3. Ensure that you are in advanced filter mode. If you aren't, click **Switch to advanced**.

The screenshot shows the 'Filters' pane in 'Basic' mode. The 'Basic (Switch to advanced)' button is highlighted. Below it, there is a search bar and a list of characteristics: 'Asset Type', 'Business Term', and 'Acronym'. A 'Properties' section is also visible.

4. In the **Filters** pane, define the filter clauses.
 - a. Select a characteristic from the **Characteristic** list.
 - b. Select an operator.
 - c. Add one or more values.

The content of the value field depends on the selected operator.

- d. Click **Add filter criteria** to add the next filter clause.
5. In the **Filter rule** field, define how the filter clauses must be interpreted. See [Filter rules](#).
6. Click **Apply** to activate the filter or **Cancel** to discard the changes.

Tip

If you want to filter assets by relation type and use an exclusionary logic operator, such as **does not equal** or **does not contain**, you have to introduce two filter clauses, as shown in the following example.

The screenshot shows the 'Filters' interface with two clauses:

- Clause A:** Status equals Accepted.
- Clause B:** Characteristic does not equal CRT.

The filter rule is set to 'A AND B'. The resulting asset list is as follows:

Name	Asset Type
1 Month Actual Sales	Business Term
3 Month Actual Sales	Business Term
3 Month Forecast	Business Term
3 Month Forecast Price	Business Term
6 Month Actual Sales	Business Term
6 Month Forecast	Business Term
9 Month Actual Sales	Business Term
9 Month Forecast	Business Term
Actuals	Business Term

A. This filter clause conveys that you only want to consider assets that have the relation type, for example, **Asset synonym of asset Asset**.

B. This filter clause shows, of all assets that have the filter type that is specified in clause A, for example, **Asset synonym of asset Asset** relation, only the assets for which the acronym **does not equal** a specified value, in this example **CRT**.

The screenshot shows the 'Filters' interface with one clause:

- Clause A:** Asset synonym of asset Asset does not equal CRT.

The filter rule is set to 'A'. The resulting asset list is as follows:

Name	Status	Asset Type
Cathode Ray Tube	Candidate	Business Term
CRT	Candidate	Business Term
Universal processing code	Candidate	Business Term
UPC	Candidate	Business Term

Without the **exists** filter clause, the filter results will include assets that do not have the **Asset synonym of asset Asset** relation type, which is not helpful.

Filter rules

When you create an advanced filter, you can create complex filters by combining the filter clauses you created with [Create an advanced filter](#). By default, the filter clauses are combined with the AND (conjunction) operator. However, you can also combine the clauses by using brackets and the OR (disjunction) operator.

Operator	Explanation
AND	<p>A result must fit all filter clauses.</p> <p>Example: A AND B AND C means that only a resource that fits all three filter clauses is added to the results.</p>
OR	<p>A result must fit one of the filter clauses.</p> <p>Example: A OR B OR C means that whenever a resource fits one of the three filter clauses, it is added to the results.</p>

A filter uses the following operator precedence to filter the data:

1. Operations inside brackets.
2. AND operations.
3. OR operations.

Filter rule examples

- A OR B AND C:
 - First, check the AND operation. The result must fit clause B and C.
 - Second, combine it with clause A. The result must fit either A or the result of the AND operation.
- (A OR B) AND C:
 - First, check the operation between brackets. The result must fit either clause A or clause B.
 - Second, combine it with clause C. The result must fit clause C and the result of the operation between brackets.

Reset a filter

If you have applied a filter and you want to return to the original view, follow these steps:

1. Open a view and apply a filter.
2. Click **Revert to original**.



3. In the **Revert to original** dialog box, click **Revert**.
You return to the originally selected view.

Display modes

Throughout Collibra Data Governance Center, you can choose to view assets in tables (table display mode) or as sets of tiles (tiles display mode).

When assets are viewed in table display mode, each table row represents one asset. When they are shown in tile display mode, each tile represents one asset.

Example of a view in table display mode:

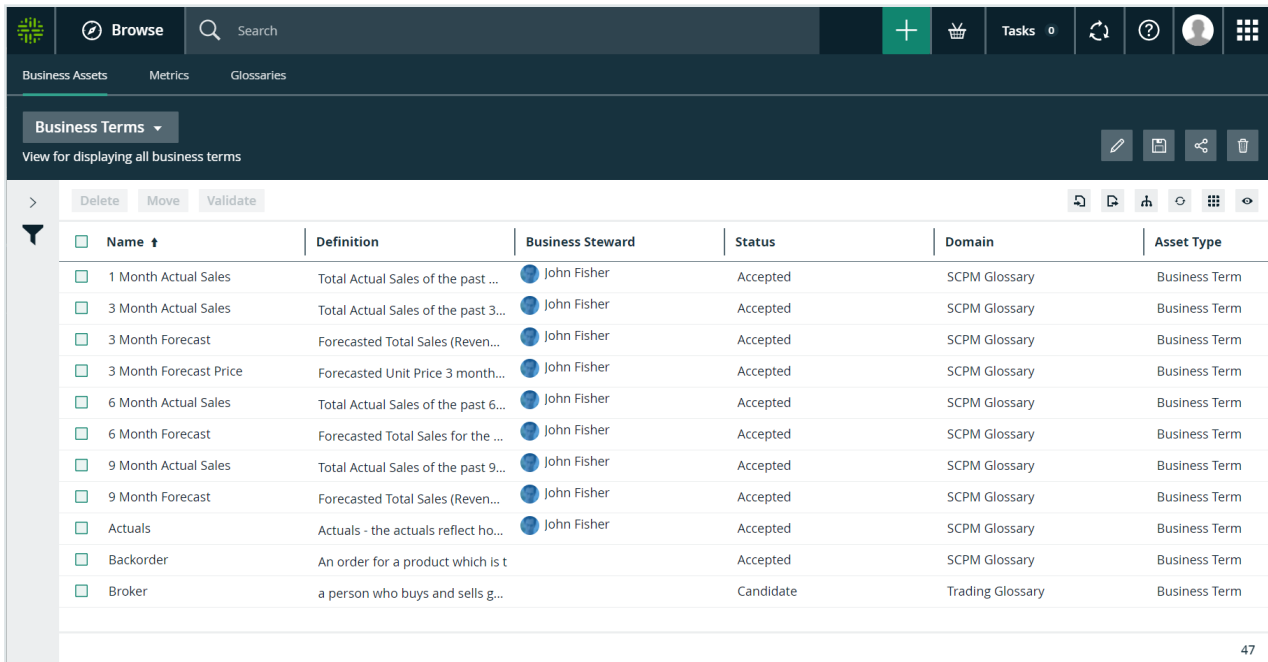

Name	Definition	Business Steward	Status	Domain	Asset Type
1 Month Actual Sales	Total Actual Sales of the past ...	John Fisher	Accepted	SCPM Glossary	Business Term
3 Month Actual Sales	Total Actual Sales of the past 3...	John Fisher	Accepted	SCPM Glossary	Business Term
3 Month Forecast	Forecasted Total Sales (Reven...	John Fisher	Accepted	SCPM Glossary	Business Term
3 Month Forecast Price	Forecasted Unit Price 3 month...	John Fisher	Accepted	SCPM Glossary	Business Term
6 Month Actual Sales	Total Actual Sales of the past 6...	John Fisher	Accepted	SCPM Glossary	Business Term
6 Month Forecast	Forecasted Total Sales for the ...	John Fisher	Accepted	SCPM Glossary	Business Term
9 Month Actual Sales	Total Actual Sales of the past 9...	John Fisher	Accepted	SCPM Glossary	Business Term
9 Month Forecast	Forecasted Total Sales (Reven...	John Fisher	Accepted	SCPM Glossary	Business Term
Actuals	Actuals - the actuals reflect ho...	John Fisher	Accepted	SCPM Glossary	Business Term
Backorder	An order for a product which is t		Accepted	SCPM Glossary	Business Term
Broker	a person who buys and sells g...		Candidate	Trading Glossary	Business Term

Example of a view in tile display mode:

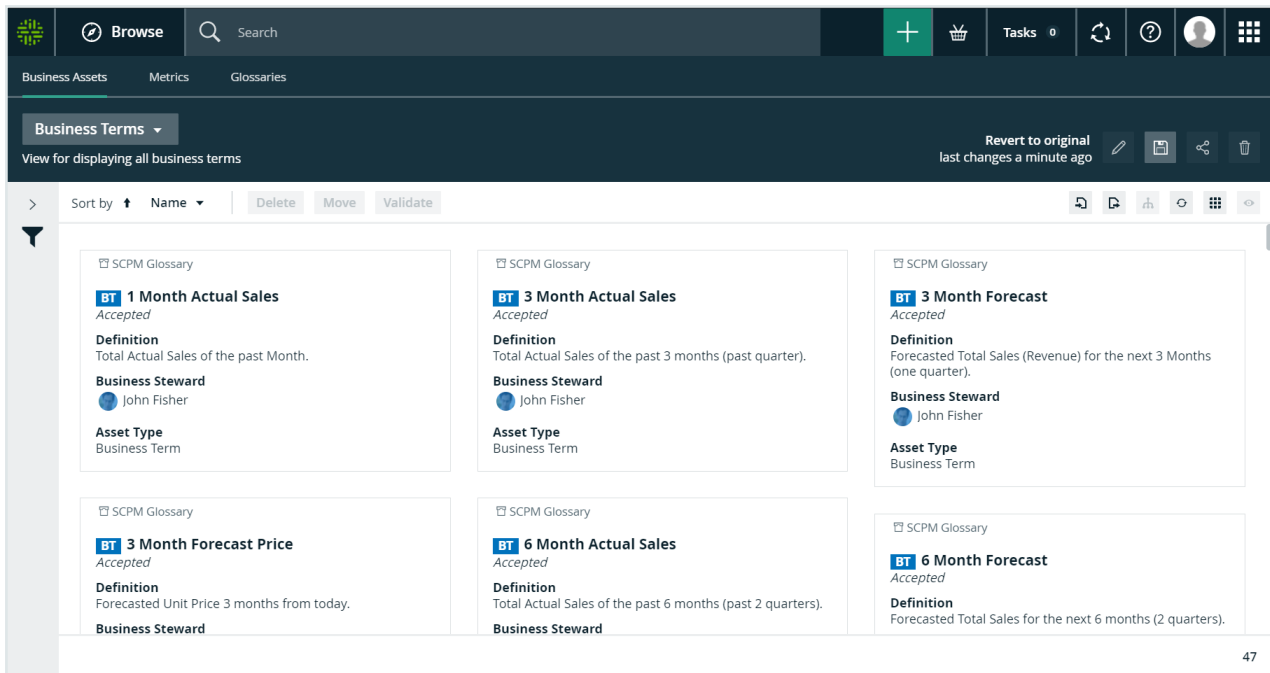
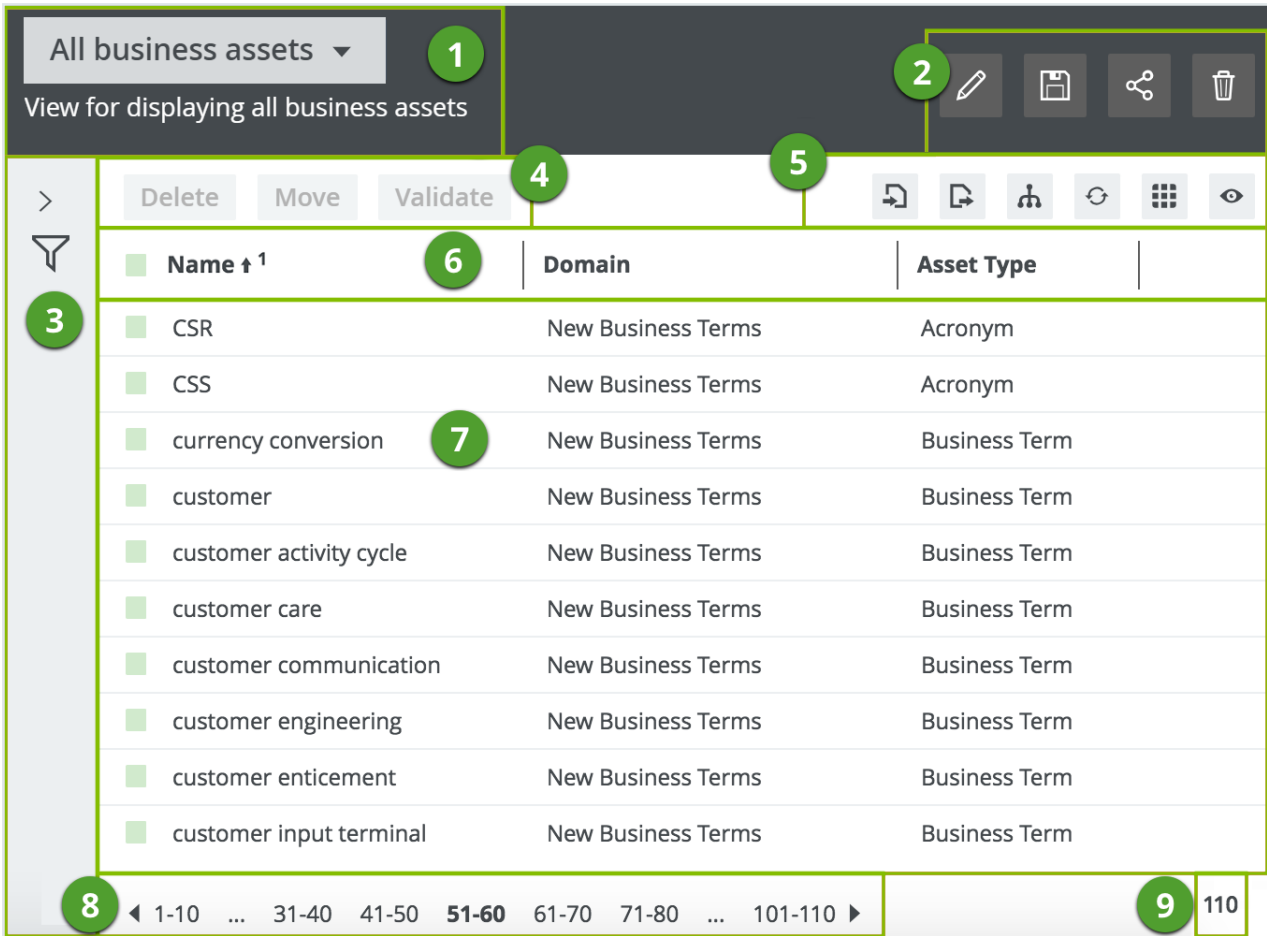

Table display mode

When resources are viewed in table **display mode**, each table row represents one community, domain, asset or so forth. You can also **switch** to tile display mode.

Working with tables

All tables in DGC have some common features and actions. For some tables, you can do additional actions.



No.	Element name	Description
1	View selector	The view selector shows the name and description of the current view, and allows you to choose another view.
2	View toolbar	The view bar contains buttons to save , edit , share and delete the current view.
3	Asset filter	You can use an asset filter to limit the number of assets shown.
4	Action menu	The action toolbar contains a selection counter and actions that you can perform on assets you select in the table.

No.	Element name	Description
5	Table menu	The table menu contains buttons for actions that you can perform on the table.
6	Fields	<p>The fields are the column headers.</p> <p>You can customize the table to determine which fields are shown and in which order they're shown. You can also rename the field display names.</p> <p>From the header, you can</p> <ul style="list-style-type: none"> • Select all visible assets. • Sort on one or more columns, in ascending or descending order. • Apply a column filter. • Clear a column filter.
7	Body	<p>The body of the table shows the actual content of the table in rows.</p> <p>From a table, you can do the following:</p> <ul style="list-style-type: none"> • Select a row. • Edit the content of one, selected or all visible cells.
8	Pages	<p>The table pages. This section appears if the table contains more rows than you are displaying.</p> <p>You can do the following:</p> <ul style="list-style-type: none"> • Define the number of rows per page. • Navigate between table pages.
9	Counter	<p>The total number of assets in the table.</p> <p>If the table contains more than 10 000 rows, the counter displays 10 000 +. Click it to see the exact count.</p>

Switch to table display mode

If you are in tiles display mode, you can quickly convert the set of tiles to a table.

Steps

1. Do one of the following:
 - Open a view in tiles display mode.
 - Open an asset page with related assets shown in tiles display mode.
2. In the content toolbar, click  → **Display mode** → **Table**.

Action toolbar

The **action toolbar** contains a selection counter and actions that you can perform on assets you select in the table.

3 / 47		Delete	Move	Validate	Approval	Simple Approval	Vote
<input type="checkbox"/>	Name ↑			Asset Type			
<input checked="" type="checkbox"/>	1 Month Actual Sales			Business Term			
<input checked="" type="checkbox"/>	3 Month Actual Sales			Business Term			
<input checked="" type="checkbox"/>	3 Month Forecast			Business Term			
<input type="checkbox"/>	3 Month Forecast Price			Business Term			
<input type="checkbox"/>	6 Month Actual Sales			Business Term			
<input type="checkbox"/>	6 Month Forecast			Business Term			

You can:





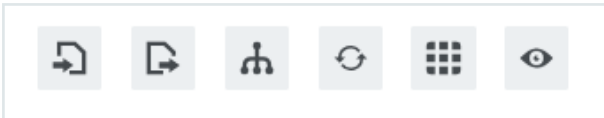

- **Delete** multiple assets.
- **Move** multiple assets to another domain.
- **Validate** assets.
 - This is only visible if a **validation rule** is assigned to the **asset type**.
- **Start** an asset workflow from an asset table.
 - Only workflows that apply to all the selected assets are available.

Table content toolbar

When you are viewing assets in table display mode, the content toolbar contains buttons for actions that you can perform on the table.



The following table provides an overview of the possible actions:

Button	Description
	Import assets or complex relations.
	Export assets or complex relations.
	<p>Display a selection of assets as a hierarchy, or tree structure, based on their relation type.</p> <p>When you select only one relation type, Collibra Data Governance Center builds the hierarchy as deeply as possible, traversing occurrences of that single relation type as often as it can.</p> <p>Enable or disable hierarchies.</p>
	Refresh the table.
	<p>Manage columns and rows. You can add, remove and move columns and select the number of rows that are displayed on one page. See Customizing tables.</p> <p>You can also switch to tile display mode.</p>
	Display a preview of the selected row. You can select a row by clicking on the row itself, not the check box.

Select or clear rows

To edit or delete multiple rows in one go, you can select multiple rows in a table.

Note Do not confuse this with highlighting a row by clicking anywhere in the row.

Steps

1. Open a view in table display mode.
2. Do one of the following:

If you want to...	do...
select a single row:	Click the checkbox in front of the row.
select all visible rows:	Click the checkbox in the header of the column.
clear a selected row:	Click a selected checkbox again.



Tip In the table header, you can see how many of the available assets are selected.



3 / 50	Delete	Move
<input type="checkbox"/>	Name ↑	
<input checked="" type="checkbox"/>	1 Month Actual Sales	
<input checked="" type="checkbox"/>	3MFctRevByProduct	
<input type="checkbox"/>	3 Month Actual Sales	
<input checked="" type="checkbox"/>	3 Month Forecast	
<input type="checkbox"/>	3 Month Forecast Price	

Edit cells in a table

You can edit most content in [tables](#). You can do this for individual rows or multiple rows in one go.

Steps

1. Open a view in table display mode.
2. Do one of the following:
 - Double-click a cell.
 - Hover your mouse over a cell and click .
 - » The cell editor appears.
3. Do one of the following:
 - If the field is a free text field, you can edit the cell by typing.
 - If the field is a drop-down list, type the new value or use the drop-down menu .
 - If the field is a date, type the new date or use the date editor .
4. Do one of the following:

If you want to change...	do...
the current row only:	a. Click  .
all visible rows:	a. Click Apply to all visible rows. b. Click  .
selected rows:	a. Select one or more rows. b. Click Apply to all selected rows. c. Click  .

Wrap the text in a cell of a table



Collibra Data Governance Center can wrap the text in cells of [tables](#) so it appears on multiple lines inside the cell. This makes the cell content more readable.

Wrap the text of an individual cell

1. Open a view in table display mode.
2. Hover your mouse over a cell and click .
 - » The height of the table row increases so the complete text in all cells in that row becomes readable.

Note You cannot save the wrapping, so when you reload the page or open the view later, the text is no long wrapped.

Wrap the text of all cells

1. Open a view in table display mode.
2. In the content toolbar, click  → **Wrap Text**.
 - » The pagination of the table is set to 20 rows per page.
 - » The height of all table rows increases so the complete text in the cells becomes readable.
3. Optionally, in the view toolbar, click , then **Save** to save the view and always wrap the text when the view opens.

Customizing tables



If you want a table to display only the information you need about specific assets, you can change several aspects of the table.

Add columns to a table

In Collibra Data Governance Center, a table has a default view, displaying a default set of columns. You can edit the asset view by adding columns to it.

Note You can also [show responsibilities](#) as a column.

Steps

1. Open a view in table display mode.
2. In the content toolbar, click  →  **Edit Fields**.
 - » The **Fields** dialog box appears.
3. Click **Select fields**.
 - » The **Select fields** dialog box appears.
4. Select one or more items in the list.

Tip You can use predefined filters and the search box to quickly find columns.



5. Click **Update**.
 - » The **Select fields** dialog box appears.
6. If required, do the following:
 - [Edit a column name](#).
 - [Edit the column order](#).
7. Click **Save**.

Show responsibilities in an asset table



An asset view can show the **responsibilities** of a resource, these responsibilities are shown per role.

If you enabled inherited responsibilities in the settings, you can show the **inherited responsibilities**. Inherited responsibilities have a gray background and cannot be edited in an asset view. Direct responsibilities have a white background and can be **edited**.

Example

<input type="checkbox"/> Name ↑	Asset Type	Business Steward
<input type="checkbox"/> customer revenue	Business Term	 Anita Morrison  John Fisher

Steps

1. Open a view in table display mode.
2. In the content toolbar, click  →  **Edit Fields**.
 - » The **Fields** dialog box appears.
3. Click **Select fields**.
 - » The **Select fields** dialog box appears.
4. Select one or more roles in the list.

Tip You can find all roles in the **Roles** tab page.

5. Click **Update**.
 - » The **Select fields** dialog box appears.

Tip If you enabled inherited responsibilities in Collibra Console, you can select **Show inherited responsibilities** to show inherited responsibilities.



6. Click **Save**.

Edit the column order

You can edit the order in which the columns are arranged in a table.

Note If you enable hierarchies for a table, the Name column automatically appears as the leftmost column in the table and it is frozen. More information: [Freeze columns](#).



Steps

1. Open a view in table display mode.
2. In the content toolbar, click  →  **Edit Fields**.
 - » The **Fields** dialog box appears.
3. Click  and drag a row up or down.
4. Click **Save**.

Edit a column name

You can edit the column names in a table.

Steps

1. Open a view in table display mode.
2. In the content toolbar, click  →  **Edit Fields**.
 - » The **Fields** dialog box appears.
3. In the **Display name** field, type a new name.
4. Click **Save**.



Remove columns from a table

You can remove columns from tables in two ways:

Remove columns from the **Table Columns** dialog box

Do this if you want to remove one column.



Steps

1. Open a view in table display mode.
2. In the content toolbar, click  →  **Edit Fields**.
 - » The **Fields** dialog box appears.
3. At the end of the line, click .
4. Click **Save**.

Remove columns from the **Select Columns** dialog box

Do this if you want to remove several columns or add columns in one go.

Steps

1. Open a view in table display mode.
2. In the content toolbar, click  →  **Edit Fields**.
 - » The **Fields** dialog box appears.
3. Click **Select fields**.
 - » The **Select fields** dialog box appears.
4. Clear the check box in front of one or more items in the list.

Tip You can use predefined filters and the search box to quickly find columns.

5. Click **Update**.
6. Click **Save**.

Change the number of rows per page

If a table contains a large amount of rows, they will be split across multiple pages. You can change the number of rows that are shown per page of the table.

Steps

To change the number of rows per page, follow these steps:



1. Open a view in table display mode.
2. In the content toolbar, click  → **Change Rows per Page** → <number>.

Freeze columns

Freezing columns keeps the leftmost columns in a table visible when you scroll horizontally to the right.

Note If you enable hierarchies for a table, the **Name** column automatically appears as the leftmost column in the table and it is frozen. You can still [change](#) the column order.

Steps

1. Open a view in table display mode.
2. In the content toolbar, click  →  **Edit Fields**.
 - » The **Fields** dialog box appears.
3. Click  for the **Move to freeze column(s)** setting, and drag it below the last column you want to freeze.
4. Click **Save**.

Sort on one or more columns

Sorting the contents of a table helps you visualize your content and find the data you want. You can sort on one or more columns.

Note

- The availability of multi-column sorting and the maximum number of columns on which you can simultaneously sort depends on your organization's environment settings in Collibra Console.
- Multi-column sorting is not available in tile [display mode](#); however, you can sort on more than one column while in table display mode and then [switch to tile display mode](#). The sort results will be accurately applied to the tiles. See [Sort a set of tiles](#).

Steps

To sort the contents of a table based on one or more columns, follow these steps:

1. Open a view in table display mode.
2. Click the column name of the column on which you want to sort.
 - ↑ appears next to the column name and the table is sorted in ascending order.
 - To sort in descending order, click the column name again.
3. To sort the data on a second column, click the desired column name.
 - » ↑² appears next to the column name and the table is sorted in ascending order.
 - To sort in descending order, click the column name again.
 - To remove sorting, click the column name a third time.
4. To sort the data on a third column, click the desired column name.
 - » ↑³ appears next to the column name.
 - » The contents of the table are first sorted according to the first column you've selected. Within that sort result, the contents are further sorted according to the second column you've selected.
 - To sort by additional columns, continue as above.

Tip If you start sorting on a second column, the sorting icon of the first column changes into .

Navigate between table pages

If a table contains more rows than you are currently showing, it is split in several pages. You can navigate between these pages.

Tip You can define the number of rows per page. More information: [Change the number of rows per page](#).

Steps

1. Open a view in table display mode.
2. If the table contains more rows than those displayed, the lower left corner shows the pages.
 - Do one of the following:

To navigate to...	click...
the previous page	◀
the next page	▶
the first page	the first page. Example: 1-10
one of the 2 previous or following pages	the desired page.
the last page	the last page. Example: 100-110

Example

<input type="checkbox"/> Name ▲	Asset Type
<input type="checkbox"/> CSR	Acronym
<input type="checkbox"/> CSS	Acronym
<input type="checkbox"/> currency conversion	Business Term
<input type="checkbox"/> customer	Business Term
<input type="checkbox"/> customer activity cycle	Business Term
<input type="checkbox"/> customer care	Business Term
<input type="checkbox"/> customer communication	Business Term
<input type="checkbox"/> customer engineering	Business Term
<input type="checkbox"/> customer enticement	Business Term
<input type="checkbox"/> customer input terminal	Business Term

◀ 1-10 ... 31-40 41-50 **51-60** 61-70 71-80 ... 101-110 ▶

Filtering tables

You can filter tables in different ways:

- [Apply a column filter.](#)
Do this to quickly filter on a column using a simple string.
- [Asset filters.](#)
Do this to use advanced filters.

Apply a column filter

You can filter the content in a table using a column filter. When you apply a column filter, only rows containing the specified string are shown.

Tip You can also use asset filters to define complex criteria. More information: [Asset filters](#).

Steps

To apply a column filter, follow these steps:

1. Open a table.
2. In a column header, click .
3. The column header becomes a search box.
Type the text you want to filter on.

Clear a column filter

After you applied a column filter, you can clear it again to make more rows visible.

Steps

To clear a column filter, follow these steps:

1. [Apply a column filter](#).
2. In the table name, click .

Working with hierarchies

The hierarchy feature for asset views enables you to display a set of assets in a table as a hierarchy, or tree structure, based on the [relations](#) between the assets. You can select which relation types to display in the hierarchy.

A hierarchy is a visual representation of relations between assets, resulting in a tree-like path.

Note Collibra Data Governance Center uses dotted lines to graphically depict the relations between the assets in the hierarchy. Small carets (triangles) depict nodes in the hierarchy that you can expand.

When you [enable](#) hierarchies, you can choose between:

- A single-path hierarchy: for each node at a certain level in the hierarchy, there is only one path to nodes at the next level.
- A multi-path hierarchy: a hierarchy in which all relations are traversed for any asset, at any depth.

Note

- In a hierarchy, [filters](#) are only applied at the root level.
- You cannot export or import a hierarchy.
- You cannot use tile [display mode](#) in a hierarchy.

Example

Single-path hierarchy

Imagine you have assets that represent Reports. Each report asset contains Report Attribute assets.

You can depict this as a single-path hierarchy, using a single relation type:

- **[Report] contains [Report Attribute]**

In the resulting hierarchy, the maximum depth (meaning the number of relations between a root node and a leaf node) is one.

Now imagine some of those Report Attributes are represented by Business Assets, via the relation type:

- **[Data Asset] represented by [Business Asset]**

Note Keep in mind that Report Attribute is a child asset type of Data Asset.

You can depict this with a single-path hierarchy, consisting of two relation types:

- **[Report] contains [Report Attribute]**
- **[Data Asset] represented by [Business Asset]**

The maximum depth of this hierarchy will be two.

Now imagine that your Reports are grouped into other Reports, and you want to depict this as a hierarchy, as well. You can depict this as a single-path hierarchy, using a single relation type:

- **[Report] groups [Report]**

The fundamental difference between this hierarchy and the previous one is that the target asset type of the relation (Report) is the same as the source asset type (Report), which can result in a hierarchy of unlimited depth. For example:

- **Report A groups Reports B and C**
- **Report B groups Reports D and E**
- **Report C groups Reports F**

This hierarchy shows the Groups relations between the Reports, but it does not show the Report Attributes contained in each Report. Single-path hierarchy does not allow for these two relation types to be simultaneously depicted in a hierarchy:

- [Report] groups [Report]
- [Report] contains [Report Attribute]

In a single-path hierarchy, each Report node acts like a junction, at which you can view the instances of one relation type or the other, but not both.

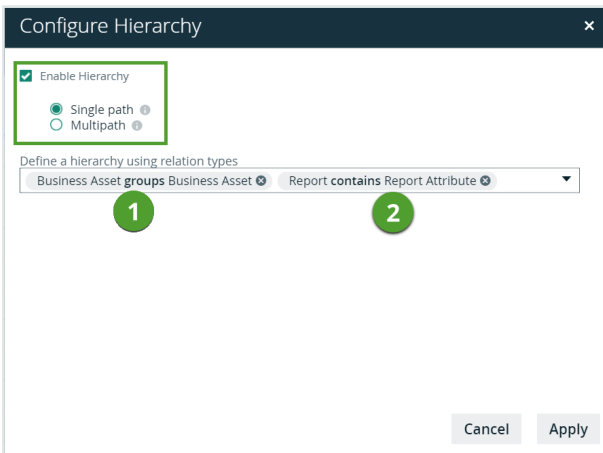

		Delete	Move	Validate
Name ↑	Asset Type			
Customer Profitability Analysis	Report	Level 1: Reports		
Customer Lifetime Value	Report			
Annual Profit Contribution	Report Attribute	Level 2: Report Attributes		
Customer	Report Attribute	No Report Attributes at level 1		
Customer Acquisition Cost	Report Attribute			
Discount Rate	Report Attribute			
Lifetime Value	Report Attribute			
Retention Rate	Report Attribute			
Financial Statements	Report			
FRY-14M-CCAR	Report	Level 1: Reports		
FRY-14Q-CCAR	Report			
FRY - 9C	Report			

Multi-path hierarchy

This is where multi-path hierarchy comes into play: at each junction, any relation type in the hierarchy path is traversed to find more nodes. For example, you can simultaneously view:

- [Report] groups [Report]
- [Report] contains [Report Attribute]
- [Data Asset] represented by [Business Asset]

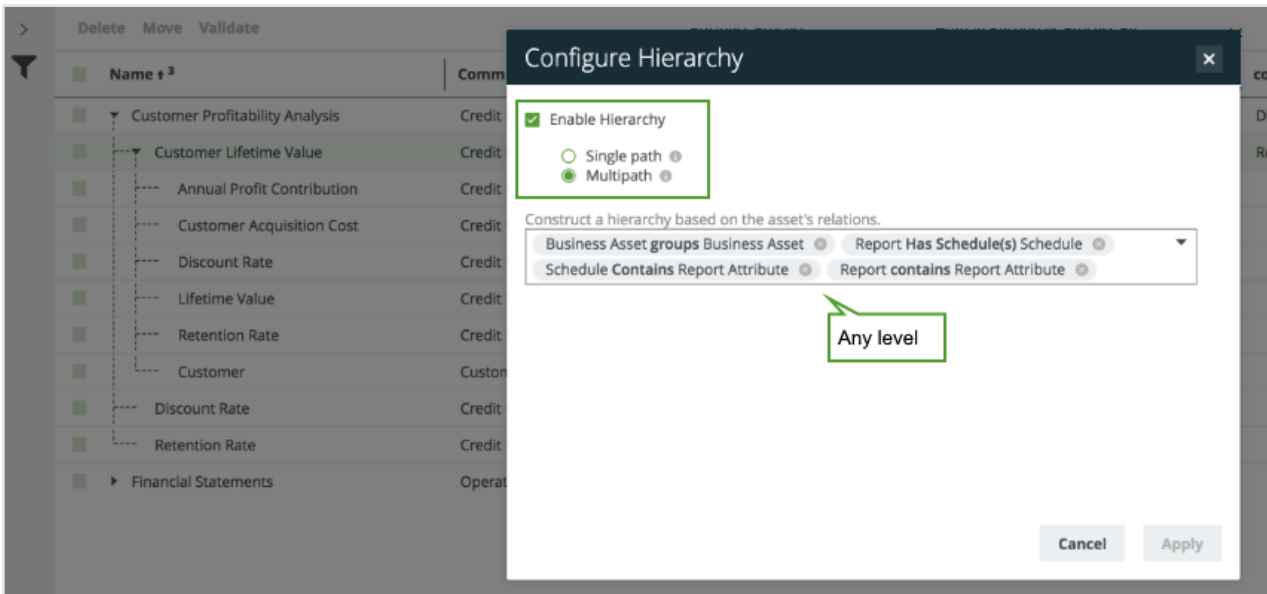

Name	Asset Type
Customer Profitability Analysis	Report
Customer Lifetime Value	Report
Annual Profit Contribution	Report Attribute
Customer	Report Attribute
Customer Acquisition Cost	Report Attribute
Discount Rate	Report Attribute
Lifetime Value	Report Attribute
Retention Rate	Report Attribute
Discount Rate	Report Attribute
Retention Rate	Report Attribute
Financial Statements	Report

Report Attributes at level 1

Enable or disable hierarchies

You can enable [hierarchies](#) to display an asset table in a tree structure, or disable hierarchies to display a 'flat' asset table.

Steps

1. Open a view in table display mode.
2. In the content toolbar, click .
 - » The **Configure Hierarchy** dialog box appears.
3. Enter the required information.

Field	Description
Enable Hierarchy	Select or clear to respectively enable or disable hierarchies.
Single path	For each node at a certain level in the hierarchy, there is only one path to nodes at the next level.
Multipath	A hierarchy in which all relations are traversed for any asset, at any depth.
Construct a hierarchy based on the asset's relations	Enter the relation types that you want to use for your hierarchy.

4. Click **Apply**.

Tile display mode

When resources are shown in tile [display mode](#), each tile represents one asset. You can also [switch](#) to table display mode.

Working with tiles

In tile display mode, each tile represents one asset. The tiles have some common features and actions.

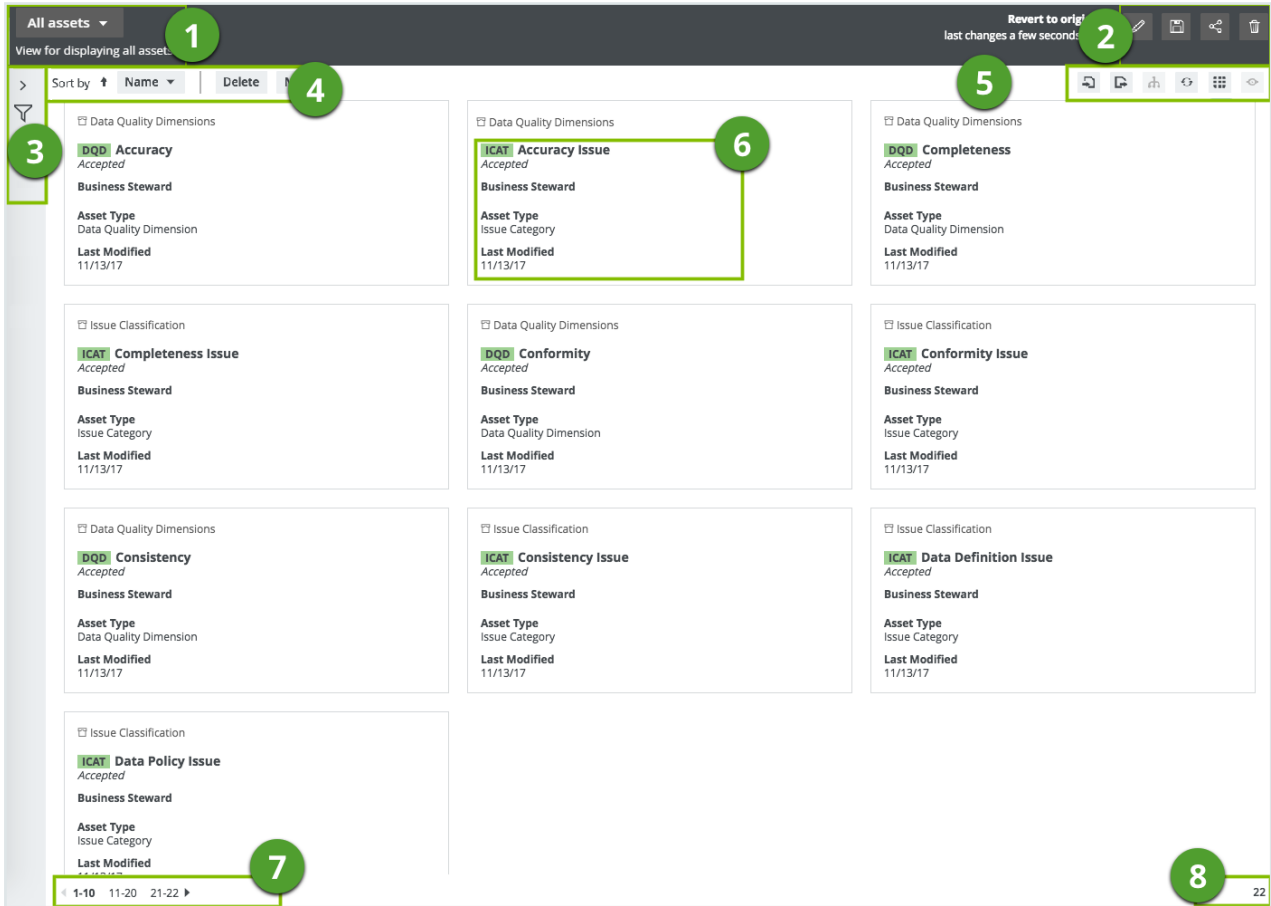

No.	Element name	Description
1	View selector	The view selector shows the name and description of the current view, and allows you to choose another view.
2	View bar	The view bar contains buttons to save , edit , share and delete the current view.
3	Asset filter	You can use an Asset filters to limit the number of tiles that are displayed.

No.	Element name	Description
4	Tiles action menu	<p>The tiles action menu with a selection counter and buttons that enable you to:</p> <ul style="list-style-type: none"> • Sort the tiles in ascending or descending order, by field. • Delete multiple assets. • Move multiple assets to another domain. • Validate assets. This is only visible if a validation rule is linked to the asset type. • Start a workflow from a table. Only workflows that apply to all the selected assets are available.
5	Tiles menu	The Tiles content toolbar contains buttons for actions that you can perform on the set of tiles.
6	Fields and values	<p>Fields and values of the asset.</p> <p>You can customize a set of tiles by adding, moving and removing fields and selecting the number of tiles that are displayed per page.</p>
7	Pages	<p>The tiles pages. This section appears if there are more tiles than you are displaying on one page.</p> <p>You can:</p> <ul style="list-style-type: none"> • Change the number of per page. • Navigate between tiles pages.
8	Counter	<p>The total number of tiles.</p> <p>If a set of tiles contains more than 10 000 tiles, the counter displays 10 000 +. Click it to see the exact count.</p>

Switch to tiles display mode

If you are in table display mode, you can quickly convert the table to a set of tiles.

Steps

1. Open a view in table display mode.
2. In the content toolbar, click  → **Change Display Mode** → **Tiles**.

Tiles action toolbar

The tiles action toolbar contains a selection counter and actions you can perform on selected tiles.

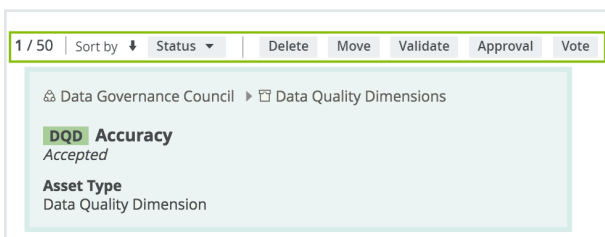

You can:







- **Sort** the tiles in ascending or descending order, by field.
- **Delete** multiple assets.
- **Move** multiple assets to another domain.
- **Validate** assets.
This is only visible if a validation rule is linked to the asset type.
- **Start** a workflow from a table.
Only workflows that apply to all the selected assets are available.

Tiles content toolbar

When you are viewing assets in tile **display mode**, the content toolbar contains buttons for actions that you can perform on a set of tiles.



The following table provides an overview of the possible actions:

Button	Description
	Import assets or complex relations.
	Export assets or complex relations.
	Enable or disable hierarchies . <div style="background-color: #f0f0f0; padding: 5px;"> <p>Note The hierarchy feature is only available in table display mode.</p> </div>
	Refresh the table.
	Manage fields and tiles count. You can customize a set of tiles by adding, moving and removing fields and selecting the number of tiles that are displayed per page. You can also switch to table display mode .
	Enable or disable the preview. <div style="background-color: #f0f0f0; padding: 5px;"> <p>Note Preview is only available in table display mode.</p> </div>

Customize a set of tiles



If you want a set of tiles to display only the information you need about the assets, you can change several aspects of the tiles.

Add fields to a set of tiles

In Collibra Data Governance Center, a set of tiles has a default view, displaying a default set of fields. You can add, [remove](#) and [rename](#) the fields that appear in the tiles.

Note You can also [show responsibilities](#) as a field.

Steps

1. Do one of the following:
 - Open a view in tiles display mode.
 - Open an asset page with related assets shown in tiles display mode.
2. In the content toolbar, click  →  **Edit Fields**.
 - » The **Fields** dialog box appears.
3. Click **Select fields**.
 - » The **Select fields** dialog box appears.
4. Select one or more items in the list.

Tip You can use predefined filters and the search box to quickly find fields.

5. Click **Update**.
6. If required, do the following:
 - [Change a field name](#).
 - [Change the order of the fields](#).
7. Click **Save**.

Show responsibilities in a tile set



Tiles can show the **responsibilities** of a resource, these responsibilities are shown per role.

If you enabled inherited responsibilities in Collibra Console, you can show the **inherited responsibilities**. Inherited responsibilities have a gray background and direct responsibilities have a white background.

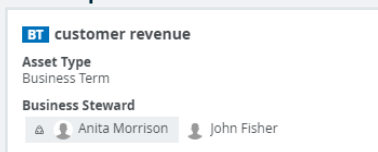
Example



Steps

1. Do one of the following:
 - Open a view in tiles display mode.
 - Open an asset page with related assets shown in tiles display mode.
2. In the content toolbar, click  →  **Edit Fields**.
 - » The **Fields** dialog box appears.
3. Click **Select fields**.
 - » The **Select fields** dialog box appears.
4. Select one or more roles in the list.

Tip You can find all roles in the **Roles** tab page.

5. Click **Update**.
 - » The **Select fields** dialog box appears.

Tip If you enabled inherited responsibilities in Collibra Console, you can select **Show inherited responsibilities** to show inherited responsibilities.



6. Click **Save**.

Edit the order of the fields

You can edit the order in which the fields are arranged in a set of tiles.

Note The community-domain breadcrumb will always appear at the top of the tile, followed by the asset name, status and report image, if an image has been uploaded for the asset.

Steps

1. Do one of the following:
 - Open a view in tiles display mode.
 - Open an asset page with related assets shown in tiles display mode.
2. In the content toolbar, click  →  **Edit Fields**.
 - » The **Fields** dialog box appears.
3. Click  and drag a field up or down.
4. Click **Save**.

Edit a field name

You can edit the field names in a set of tiles.

Steps



1. Do one of the following:
 - Open a view in tiles display mode.
 - Open an asset page with related assets shown in tiles display mode.
2. In the content toolbar, click  →  **Edit Fields**.
 - » The **Fields** dialog box appears.
3. In the **Display name** field, type a new name.
4. Click **Save**.

Remove fields from a set of tiles



You can remove fields from a set of tiles in two ways:

- Use the **Fields** dialog box.
Do this if you want to remove a single field.
- Use the **Select fields** dialog box.
Do this if you want to add or remove one or more fields in one go.

Remove fields using the **Fields** dialog box

1. Do one of the following:
 - Open a view in tiles display mode.
 - Open an asset page with related assets shown in tiles display mode.
2. In the content toolbar, click  →  **Edit Fields**.
 - » The **Fields** dialog box appears.
3. Click  for the field you want to remove.
4. Click **Save**.

Remove fields using the **Select fields** dialog box

1. Do one of the following:
 - Open a view in tiles display mode.
 - Open an asset page with related assets shown in tiles display mode.
2. In the content toolbar, click  →  **Edit Fields**.
 - » The **Fields** dialog box appears.
3. Click **Select fields**.
 - » The **Select fields** dialog box appears.
4. Clear the check box in front of one or more items in the list.

Tip You can use predefined filters and the search box to quickly find fields.

5. Click **Update**.
6. Click **Save**.

Edit the number of tiles per page

If a view contains a large amount of tiles, they will be split across multiple pages. You can change the number of tiles that are shown per page.

Steps

1. Do one of the following:
 - Open a view in tiles display mode.
 - Open an asset page with related assets shown in tiles display mode.
2. In the content toolbar, click  → **Change Rows per Page** → <number>.

Select multiple tiles

When you select a single tile, all of the actions available to you appear above the tiles, in the [tiles action menu](#). The same is true when you select multiple tiles. For all of the tiles you've selected, you can perform the same actions or start a workflow.

Note Only workflows that apply to all selected tiles are available.

Steps

To select multiple tiles, follow these steps:

1. Do one of the following: Open a view in tiles display mode. Open an asset page with related assets shown in tiles display mode.
2. To select consecutive tiles, click the first tile, press and hold down the **Shift** key, and then select the last tile you want.
3. To select non-consecutive tiles:
 - If you're working with Windows OS, press and hold down the **Ctrl** key, and then click each tile you want.
 - If you're working with macOS, press and hold down the **Command** key, and then click each tile you want.

Sorting tiles

Sorting tiles helps you visualize your content and find the data you want. You can [sort a set of tiles](#) in ascending or descending order, by the field of your choice.

Tip In tile [display mode](#), you can only sort on one field at a time, whereas in table display mode, you can [sort on one or more columns](#) simultaneously. However, if you sort on more than one column in table display mode and then [switch to tiles display mode](#), the results of the multi-column sorting is carried over to the tiles. If you then change the sorting while in tile display mode, the sort will be based on the single field of your choice.

Sort a set of tiles

You can sort a set of tiles by the field of your choice.

Steps

1. Do one of the following:
 - Open a view in tiles display mode.
 - Open an asset page with related assets shown in tiles display mode.
 - » By default, the tiles are arranged in descending alphabetical order, by name.
2. Do one of the following:
 - On the left, click **Name**, or if sorting has been done by another field, click that field name.
 - If you or someone else sorted on more than one column in table display mode and you then switched to tile display mode (see the note below), click ▼ .
 - » A drop-down menu appears, with all the fields that are currently visible for the set of tiles.
3. Select the field by which you want to sort the tiles.
 - » The tiles are sorted in descending order.
4. Optionally, click ↓ to sort in ascending order.

Note If you or someone else sorted on more than one column in table display mode and then you switch to tile display mode, the multi-column sort is carried over to tiles. In the following example figure, the table was sorted by the **Name** and **Domain** columns before switching to tiles display mode.

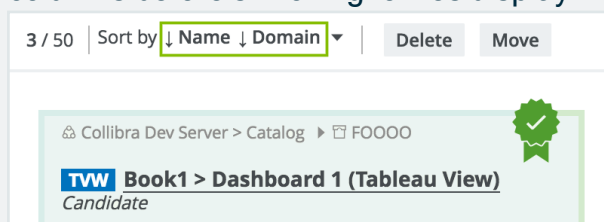

Navigate between tiles pages

If a set of tiles contains more tiles than you are currently showing, they are split across multiple pages. You can navigate between these pages.

Tip You can **change** the number of tiles per page.

Steps

1. Do one of the following:
 - Open a view in tiles display mode.
 - Open an asset page with related assets shown in tiles display mode.
2. If the set of tiles contains more tiles than those displayed, the lower left corner shows the number of pages.

Do one of the following:

To navigate to...	click...
the previous page	◀
the next page	▶
the first page	the first page. Example: 1-10
one of the two previous or following pages	the desired page.
the last page	the last page. Example: 261-268

To navigate to...	click...
<p>Example</p>	

Filtering tiles

You can use advanced [Asset filters](#) to filter the tiles shown in tile display mode.

Searching in Collibra DGC

You can use the [Search field](#) and the [Search widget](#) to quickly find any resource in Collibra Data Governance Center, including assets, communities, domains, users, user groups and more.

Both options take you to the [Search page](#), where you can edit your search text and work with the search results.

Search field

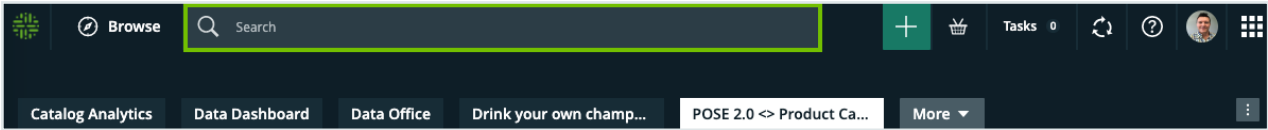

The search finds resources that contain a word that begins with your search text. For example, if you type *ca*, the search results could contain "California", "Lewis Carroll" or "Meercat".

Recently viewed

When you click in the **Search** field, the five most recently viewed resources are shown in the quick search panel.

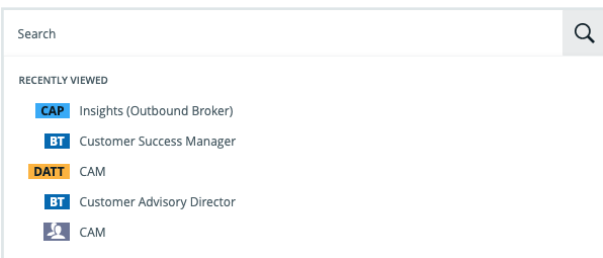

If **refreshed navigation** is enabled for your Collibra DGC environment, the search results are automatically filtered by the current domain or community if you search with a domain or community page open.

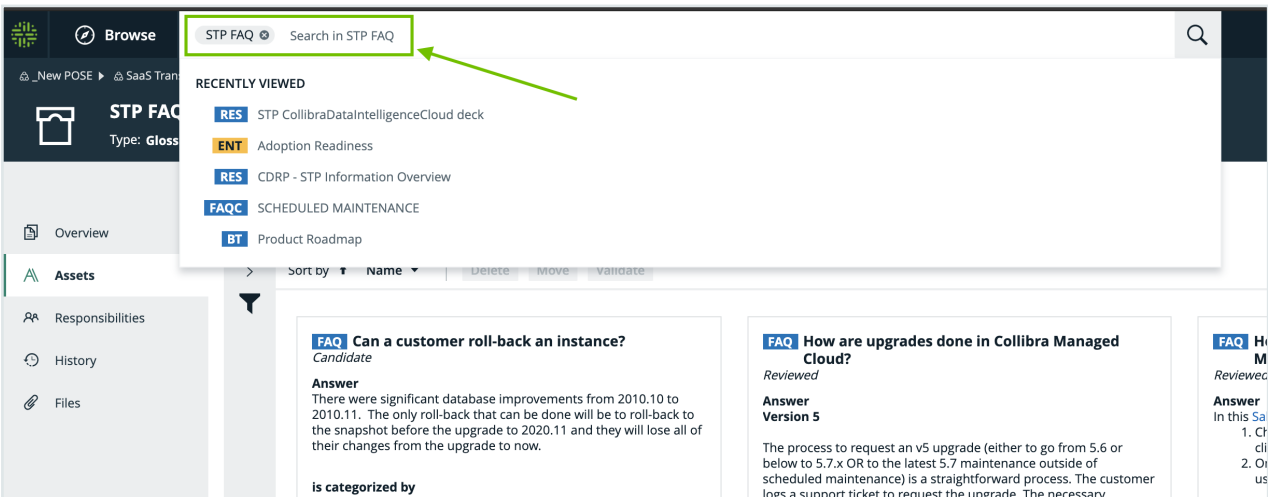

Top results

When you start typing in the **Search** field, the top 10 results are shown in the quick search panel.

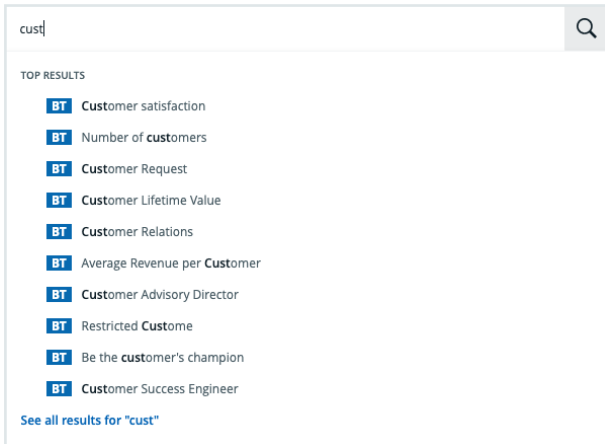

Note

- In compiling the top results, the search engine searches for your text in the **Name** field only. As such, these results might not appear as the top results on the Search page, when you launch the search.
- The order of the top results takes boosting into account.

Actions

After typing something in the **Search** field, you can do any of the following:





- Press `Enter` to start the search.
 - » The **Search page**, with results matching your search text is shown.
- Click on an asset name, to go to the asset page.

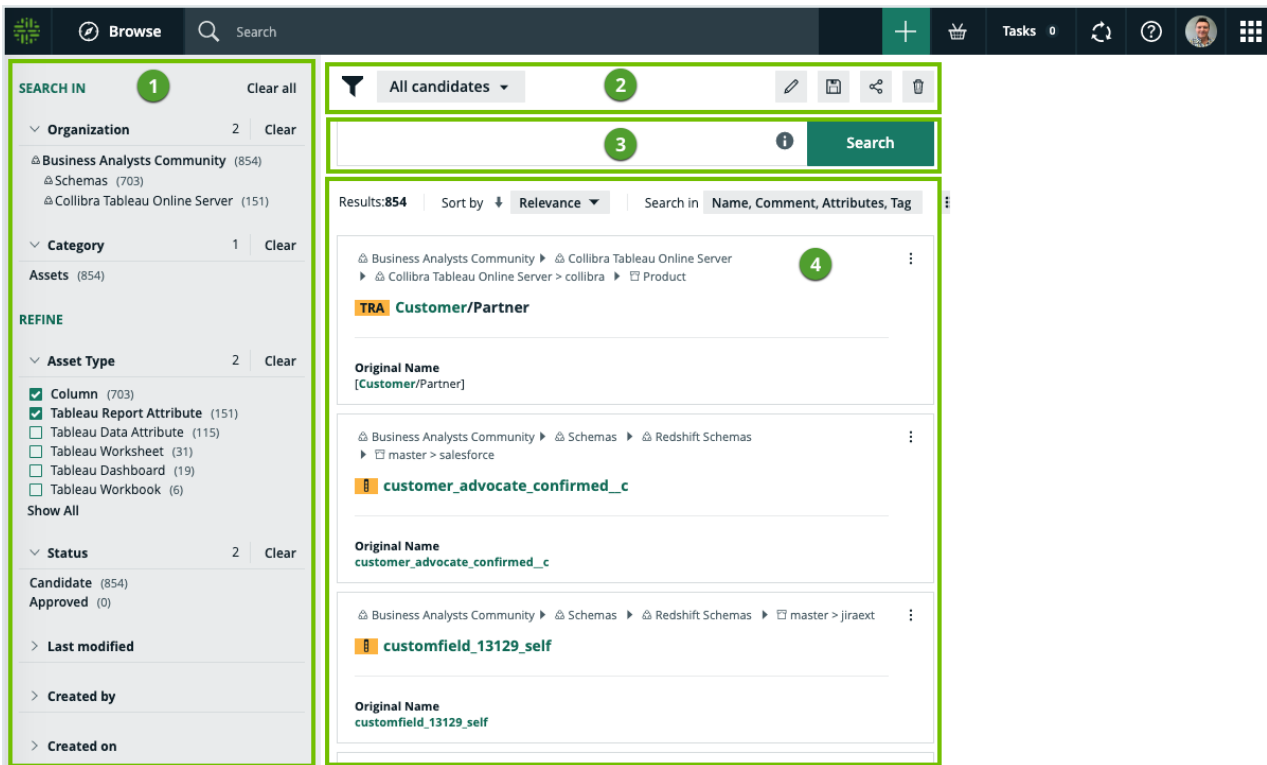

Search page

The **Search** page consists of the following areas:



No.	Part name	Description
1	Facet pane	<p>A dynamically generated collection of facets that allows you to:</p> <ul style="list-style-type: none"> • Add and remove search fields, to expand or reduce the scope of your search. • Navigate and refine the search results. <p>Note The Facet pane is only shown if your search yields results.</p>

No.	Part name	Description
2	Search filters	<p>A drop-down list of all your saved search filters, with the name of the currently applied filter shown. By default, no search filter is applied.</p> <p>The buttons allow you to:</p> <ul style="list-style-type: none">• : Create a new search filter or save a copy of an existing filter.• : Edit the name and description of a search filter.• : Share a search filter• : Delete a search filter.
3	Search input field	<p>Shows your search text. You can edit your search text here.</p> <p>Click  for examples of how wildcards and symbols work in your search text.</p>

No.	Part name	Description
4	Search results	<p>Shows:</p> <ul style="list-style-type: none"> • The results that match your search. • The total number of results. • The applied sorting criterion and sorting order. By default, search results are sorted in order of descending relevance. • The selected fields in which the search is performed. By default, all fields are searched. <p>Click  to:</p> <ul style="list-style-type: none"> • Add or remove fields that are shown for each search result. • Edit the number of results shown per page. <p>For any result that is an asset, click the three dots () to show the workflows that are available for the asset.</p> <p>Click the name of a search result to open its detailed page.</p> <div style="border-left: 2px solid #008000; padding-left: 10px; margin-top: 10px;"> <p>Tip In Collibra Console, you can influence the order of the search results by editing the boost factor of resources and attribute types. See also Relevance in search results.</p> </div>

Note It's possible that you or another user created a [search filter](#) that includes a field or facet that no longer exists in your Collibra Data Intelligence Cloud environment. In this case, the invalid field or facet is highlighted, as shown in the following image, so that you can easily identify it and delete it from the search filter. Invalid fields and facets are ignored during search queries.

The screenshot shows the Collibra search interface. On the left, there are filters for 'Organization' and 'Category'. Under 'Asset Type', the 'Invalid' option is highlighted with a green box and a red arrow. The main search area shows a search filter named 'My filter' with the search term 'a'. A red warning box states: 'The search results might not be accurate. Selected filter has invalid option (Facets)'. Below this, a search result for 'access key ID' is visible, including its definition and comments.

Wildcards and symbols for searching

If you want to find a resource, but are not quite sure of its name, you can use the following wildcards:

Wildcard	Description
?	Replaces any single character. Example: by typing <i>?owie</i> , you can find Bowie, Rowie, Mowie, and so on.

Wildcard	Description
*	Replaces any string of characters. Example: by typing <i>B*e</i> , you can find Bowie, Badge, Byte, and so on.
~	Represents a fuzzy search, words with spelling similar to the search query. Example: by typing <i>Owi~</i> , you can find Ozi, Zowie, Bowie, and so on.
!	Excludes words. Example: by typing <i>!David Bowie</i> , you can find Lester Bowie, Joe Bowie and so on.
" "	Represents a literal search. Example: by typing "David Bowie", you can find David Bowie and David Bowie Songs, but not David or Bowie.

Sort the search results

You can [sort](#) search results by the following criteria:

- [Relevance](#)
- The Name field
- The Last Modified field
- A single attribute type

Note Sorting by [attribute type](#) is only available if attribute types have been specified in Settings. To [add](#) or [delete](#) attribute types by which to sort search results, you need a [global role](#) that has the System administration global permission.

Steps

1. Perform a search via the [Search field](#) or [Search widget](#).
2. On the [Search page](#), click ▼ next to the sort field.

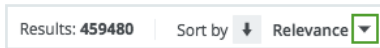

3. Select the basis by which to sort the search results.
 - » By default, the results are sorted in descending order.
4. Optionally, click ↓ to sort in ascending order.

What's next?

- If you sorted the search results by an attribute type that is not shown in the tiles, you can [add](#) it to the tiles, so that you can see the values that determined the sort order.
- You can [create](#) a search filter or edit an existing search filter, to save your sort settings as part of the saved filter configuration.

Relevance in search results

By default, search results are sorted in order of descending relevance.

What is relevance in the context of search results?

Relevance is a calculation of the similarity, measured across several lines of comparison, between your search text and the content of the resources in your Collibra DGC environment.

In a set of search results, the relevance of each resource is represented by a positive number, or score. The higher the score, the more relevant the resource is to your search text.

How are relevance scores derived?

To derive relevance scores, the Collibra DGC search engine uses a combination of query clauses and boost factors.

Query clauses

When you perform a search, the Collibra DGC search engine queries the database, using various query clauses. Each query clause compares the similarity between your search text and your Collibra DGC resources, along a different line of comparison.

The following are example objectives of different query clauses:

- Calculate the similarity between the spelling of your search term and the term found in a field in the database.
- Calculate how frequently your search term appears in a field. The more often it appears, the greater the relevance. A field containing five occurrences of a given term is more likely to be relevant than a field containing one occurrence of the term.
- Calculate the occurrence percentage of a term among all words in a particular field. For example, if your search term occurs twice in the 10-word description of an asset, that asset will have a higher relevance score than an asset for which your search term occurs twice in its 20-word description.

Boosting

Search boost factors allow you to influence the order of the [search](#) results. You can edit search boost factors to increase or decrease the importance of a resource type, field or asset type, in the search ranking.

For more information on boosting, see [Search boost settings](#).

What is a faceted search?

The Facet pane shows the relevant criteria by which to [navigate and refine](#) the search results. We refer to these criteria as facets, and the concept of using facets to navigate and refine search results as a "faceted search".

In introducing the concept of a faceted search, it may be helpful to draw the distinction between it and a more traditional filter-based search.

Filter-based search

Filters work by analyzing the search results and excluding resources (for example, assets, users and communities) that don't meet certain criteria.

In a filter-based search, the collection of filters that is available to you is constant. The relevance of the filters to the search results is not considered. As such, some of the filters available to you could either have no effect on the results, or reduce the results to a null set.

Faceted search

Facets are dynamically generated according to the resources that make up the search results. They allow you to narrow results by several different dimensions simultaneously.

In a faceted search, only facets that are relevant to the search results appear in the Facet pane on the [Search page](#). As you select facets, to navigate and refine the search results, the Facet pane is automatically updated, again showing only facets that are relevant to the refined set of results.

As shown in the following image, the facets in the Facet pane at any given moment include the number of resources that match both the search text and the value of the available facets. This gives you a view of the composition of the search results, and helps you avoid searches that yield no results.



Navigating and refining the search results

The Search page offers a variety of dynamically generated [facets](#) by which to navigate and refine your search results.

The screenshot displays a search application interface. At the top, there is a navigation bar with a 'Browse' button, a search input field, and a 'Tasks' indicator showing 0 tasks. Below the navigation bar, the interface is divided into three main sections:

- SEARCH IN (1):** A filter section with a 'Clear all' button. It includes:
 - Organization (2):** Business Analysts Community (1353), Schemas (965), and Colibra Tableau Online Server (388).
 - Category (1):** Assets (1353).
- REFINE (2):** A filter section with a 'Clear' button. It includes:
 - Asset Type (2):** Column (965), Tableau Report Attribute (388), Tableau Data Attribute (676), Tableau Worksheet (157), Tableau Dashboard (28), and Tableau Data Entity (7). A 'Show All' link is present.
 - Status (2):** Candidate (1353) and Approved (0).
 - Last modified**
 - Created by**
 - Created on**
- Search Results:** A search bar contains the text 'cust'. Below it, the results are sorted by 'Relevance' and search in 'All fields'. Three results are shown:
 - TRA: Customer/Partner:** Full Name: 5.6 enablement webinars insights > federated.0465d491jwb4zz1fr6vw60yxio7x > [Customer/Partner] (Tableau Report Attribute); Original Name: [Customer/Partner].
 - customer_advocate_confirmed_c:** Full Name: account_hist > customer_advocate_confirmed_c; Original Name: customer_advocate_confirmed_c.
 - customfield_13129_self:** (Partial view of the third result).

No.	Part name	Description						
1	"Search in" facets	<p data-bbox="467 387 1209 472">These facets enable you to navigate to resources via organizational path or resource category.</p> <table border="1" data-bbox="467 501 1417 1267"> <thead> <tr> <th data-bbox="467 501 711 591">Facet</th> <th data-bbox="711 501 1417 591">Use</th> </tr> </thead> <tbody> <tr> <td data-bbox="467 591 711 1084">Organization</td> <td data-bbox="711 591 1417 1084"> <p data-bbox="722 618 1385 792">Navigate to resources by drilling down at the organizational level and limiting the search results to a specific community, subcommunity or domain.</p> <p data-bbox="722 835 1393 1059">If, for example, you click on a root-level community, the results will be refined to include only the resources (meaning subcommunities, domains and assets) in that community that match your search text.</p> </td> </tr> <tr> <td data-bbox="467 1084 711 1267">Category</td> <td data-bbox="711 1084 1417 1267"> <p data-bbox="722 1111 1369 1240">Navigate to a specific category of resources, such as assets, communities, domains, users or user groups.</p> </td> </tr> </tbody> </table>	Facet	Use	Organization	<p data-bbox="722 618 1385 792">Navigate to resources by drilling down at the organizational level and limiting the search results to a specific community, subcommunity or domain.</p> <p data-bbox="722 835 1393 1059">If, for example, you click on a root-level community, the results will be refined to include only the resources (meaning subcommunities, domains and assets) in that community that match your search text.</p>	Category	<p data-bbox="722 1111 1369 1240">Navigate to a specific category of resources, such as assets, communities, domains, users or user groups.</p>
Facet	Use							
Organization	<p data-bbox="722 618 1385 792">Navigate to resources by drilling down at the organizational level and limiting the search results to a specific community, subcommunity or domain.</p> <p data-bbox="722 835 1393 1059">If, for example, you click on a root-level community, the results will be refined to include only the resources (meaning subcommunities, domains and assets) in that community that match your search text.</p>							
Category	<p data-bbox="722 1111 1369 1240">Navigate to a specific category of resources, such as assets, communities, domains, users or user groups.</p>							

No.	Part name	Description												
2	"Refine" facets	<p>These facets act as filters to refine the search results.</p> <p>The following table shows the packaged "refine" facets:</p> <table border="1" data-bbox="469 524 1414 1890"> <thead> <tr> <th data-bbox="469 524 651 663">Filter criteria</th> <th data-bbox="651 524 1414 663">Use this to show only those search results...</th> </tr> </thead> <tbody> <tr> <td data-bbox="469 663 651 1350">Asset type</td> <td data-bbox="651 663 1414 1350"> <p>That are of a specified asset type, such as Business Term, Acronym, Column or Table.</p> <p>This criterion is only applicable if you have selected the category Assets.</p> <p>In the following example image, the search engine searches for your text only in assets of asset type Standard, Column and Data Set.</p>  </td> </tr> <tr> <td data-bbox="469 1350 651 1485">Status</td> <td data-bbox="651 1350 1414 1485">That have a specified status, such as Candidate, Accepted, Deployed or Rejected.</td> </tr> <tr> <td data-bbox="469 1485 651 1619">Last modified</td> <td data-bbox="651 1485 1414 1619">That were modified within the specified time frame; within the last 24 hours, week, month or year.</td> </tr> <tr> <td data-bbox="469 1619 651 1753">Created by</td> <td data-bbox="651 1619 1414 1753">That were created by the specified users.</td> </tr> <tr> <td data-bbox="469 1753 651 1890">Created on</td> <td data-bbox="651 1753 1414 1890">That were created within the specified time frame; within the last 24 hours, week, month or year.</td> </tr> </tbody> </table>	Filter criteria	Use this to show only those search results...	Asset type	<p>That are of a specified asset type, such as Business Term, Acronym, Column or Table.</p> <p>This criterion is only applicable if you have selected the category Assets.</p> <p>In the following example image, the search engine searches for your text only in assets of asset type Standard, Column and Data Set.</p> 	Status	That have a specified status, such as Candidate, Accepted, Deployed or Rejected.	Last modified	That were modified within the specified time frame; within the last 24 hours, week, month or year.	Created by	That were created by the specified users.	Created on	That were created within the specified time frame; within the last 24 hours, week, month or year.
Filter criteria	Use this to show only those search results...													
Asset type	<p>That are of a specified asset type, such as Business Term, Acronym, Column or Table.</p> <p>This criterion is only applicable if you have selected the category Assets.</p> <p>In the following example image, the search engine searches for your text only in assets of asset type Standard, Column and Data Set.</p> 													
Status	That have a specified status, such as Candidate, Accepted, Deployed or Rejected.													
Last modified	That were modified within the specified time frame; within the last 24 hours, week, month or year.													
Created by	That were created by the specified users.													
Created on	That were created within the specified time frame; within the last 24 hours, week, month or year.													

No.	Part name	Description				
		<table border="1"> <tr> <td>Filter criteria</td> <td>Use this to show only those search results...</td> </tr> <tr> <td>Tags</td> <td> <p>That have the specified tag(s).</p> <p>You can click the tag in any of the search results, to search for all domains and assets with that tag.</p> </td> </tr> </table>	Filter criteria	Use this to show only those search results...	Tags	<p>That have the specified tag(s).</p> <p>You can click the tag in any of the search results, to search for all domains and assets with that tag.</p>
Filter criteria	Use this to show only those search results...					
Tags	<p>That have the specified tag(s).</p> <p>You can click the tag in any of the search results, to search for all domains and assets with that tag.</p>					

Working with facets

Click **Clear**, to clear all selections for a specific facet type.

At the top of the page, click **Clear all**, to clear all facet type selections on the search page.

Click **Show all**, to show all the facets by which to refine the scope of your search for a particular facet type. As shown in the following example image, if there are more than 15 facets, the list will open in a dialog box.

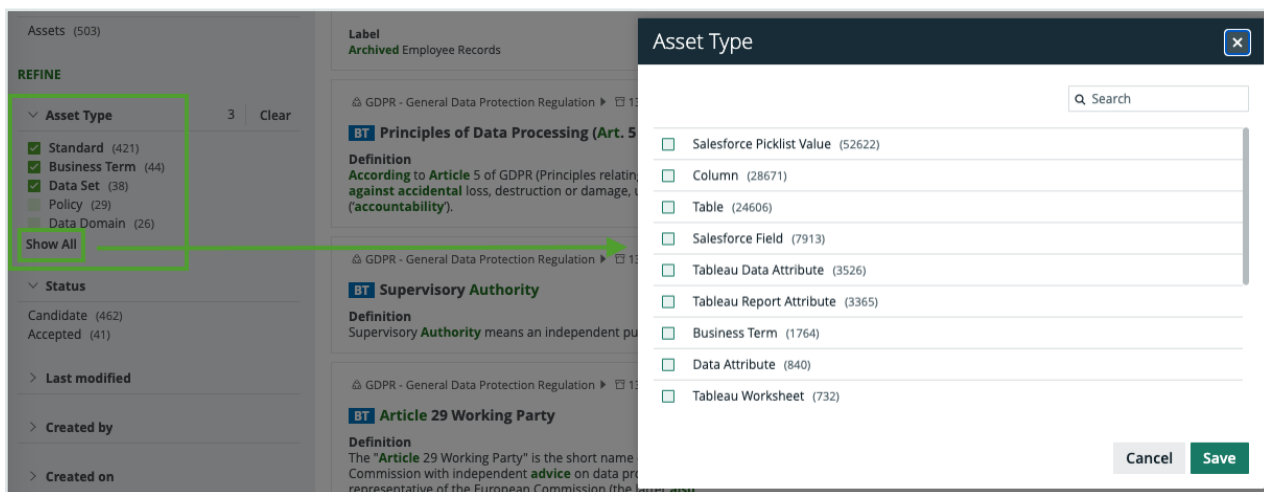

Note Adding and removing facets on the search page is not the same as:

- [Filtering](#) the search results.
- [Adding or removing](#) fields to a set of tiles.

Permissions

No particular [license](#) is needed to create and manage search filters; however, certain [global permissions](#) are needed.

Permission	With this permission, you can...
Manage and share anyone's Views, Dashboards, Search filters	Create and manage search filters for yourself and other users, and share with other users.
Manage your own Views, Dashboards, Search filters	Create and manage your own search filters.
Share your own Views, Dashboards, Search filters	Share search filters that you created.

Note Users are not granted permissions directly, but through global roles and responsibilities.

Search filters

You can create a search filter from scratch. When you create a search filter, it exists only for you. However, with the correct [global permission](#), you can [share the filter](#) with other users.

By default, no search filter is applied.

Create a search filter

You can create a [search filter](#) from scratch.

Note When you create a search filter, the [sorting](#) and search fields are part of the saved configuration.

Create a search filter via the save icon

1. Perform a search via the [Search field](#) or [Search widget](#).
 - » The [Search page](#) appears.
2. Optionally:
 - a. [Navigate and refine](#) the search results by selecting from the available facets.
 - b. [Sort](#) the search results.
 - c. [Select](#) the fields in which to search.
3. When you've achieved the desired results, click .
4. Enter a name and description of the filter.
5. Select with whom you want to share the filter.
 - Select **Public**, to share the filter with all users.
 - Select **Private**, to share the filter with no one. This is the default setting.
 - Select **Share with specific global roles, groups and users**, and then enter the relevant roles or groups.
6. Click **Save**.
 - » The new filter is added to your list of filters.

Create a search filter via the "Add a new search filter" option

1. Perform a search via the [Search field](#) or [Search widget](#).
 - » The [Search page](#) appears.
2. Click **No search filter** ▼ , and then select **Add a new search filter**.
3. Enter a name and description of the filter.
4. Select with whom you want to share the filter.
 - Select **Public**, to share the filter with all users.
 - Select **Private**, to share the filter with no one. This is the default setting.

- Select **Share with specific global roles, groups and users**, and then enter the relevant roles or groups.
5. Click **Save**.
 - » The new filter is added to your list of filters.

Save a copy of a search filter

You can save a copy of any [search filter](#), and then [edit](#) it to suit your needs.

Steps

1. Perform a search via the [Search field](#) or [Search widget](#).
2. On the [Search page](#), click on the search filter label, to expand the search filter drop-down list, and then select the relevant filter.
3. Click , and then select **Save As**.
4. Enter a name and description of the filter.
5. Select with whom you want to share the filter.
 - Select **Public**, to share the filter with all users.
 - Select **Private**, to share the filter with no one. This is the default setting.
 - Select **Share with specific global roles, groups and users**, and then enter the relevant roles or groups.
6. Click **Save**.
 - » The new filter is added to your list of filters.

Note When you save a copy of the search filter, the [sorting](#) and search fields are part of the saved configuration, but the search text is not.

Edit a filter's name and description

You can edit the names and descriptions of the [search filters](#) you've created.

Steps

1. Perform a search via the [Search field](#) or [Search widget](#).
2. On the [Search page](#), click on the search filter label, to expand the search filter drop-down list, and then select the relevant filter.
3. Click .
 - » The **Edit name and description** dialog box appears.
4. Edit the name and/or the description.
5. Click **Save**.

Edit a search filter

You can edit an existing [search filter](#) to suit your needs.

Steps

1. Perform a search via the [Search field](#) or [Search widget](#).
2. On the [Search page](#), click on the search filter label, to expand the search filter drop-down list, and then select the relevant filter.
3. In the Facet pane, reconfigure the available facets to achieve the desired filter results.
4. Click , and then select **Save**.

Share a search filter

Your [permissions](#) determine whether or not you can share [search filters](#), and if so, whether you can share only filters you've created or also the filters that others have created and shared with you.

Steps

1. Perform a search via the [Search field](#) or [Search widget](#).
2. On the [Search page](#), click on the search filter label, to expand the search filter drop-down list, and then select the relevant filter.
3. Click .

4. Select with whom you want to share the filter.
 - Select **Public**, to share the filter with all users.
 - Select **Private**, to share the filter with no one. This is the default setting.
 - Select **Share with specific global roles, groups and users**, and then enter the relevant roles or groups.
5. Click **Save**.

Delete a search filter

If you have the SysAdmin global role, you can delete your own [search filters](#) and those that other users have created and [shared](#) with you. If you don't have the SysAdmin global role, you can only delete search filters that you've created.

Steps

1. Perform a search via the [Search field](#) or [Search widget](#).
2. On the [Search page](#), click on the search filter label, to expand the search filter drop-down list, and then select the relevant filter.
3. Click .
4. Click **Delete filter** to confirm.

Text editors

Text editors in Collibra Data Governance Center allow you to enter, format and edit text.

The following text editors are available throughout Collibra DGC:

- Standard text editor.
- Mini text editor.
- Table text editor.
- Plain text editor.

Standard text editor

The standard text editor is a rich text formatting editor. You use this editor on text widgets and asset pages to edit text attributes such as Definition and Note. It allows HTML

formatting and styling. For advanced formatting, you can use the toolbar or enter HTML code after clicking `<>` in the toolbar.

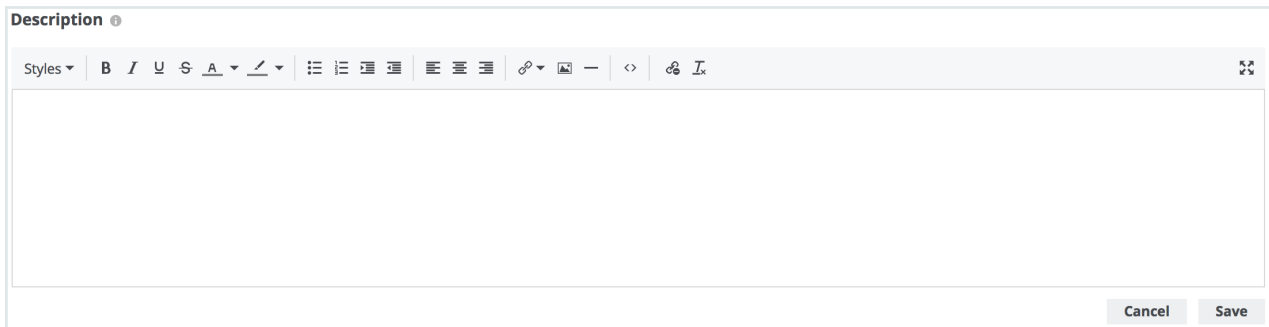

Warning

The standard text editor supports most HTML elements, inline CSS styling and table (< t >) structures. However, this means an attacker could potentially execute an XSS attack by injecting malicious HTML. However, when you save, the following HTML elements are removed for security reasons:

- script (including JavaScript)
- svg
- frame
- frameset
- iframe
- any event handlers

Text attributes are always protected, but you can also enable this for [text widgets](#) in Collibra Console. For more information, see the [Troubleshooting section](#).

Mini text editor

You use the mini text editor typically for comments, ratings and so on. The toolbar offers basic formatting options.

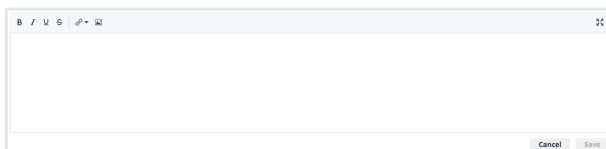
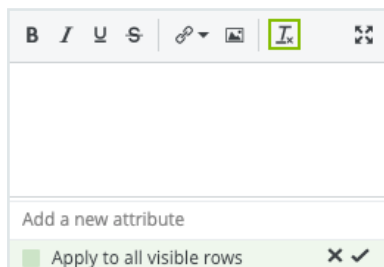

Table text editor

The table text editor allows you to edit and format text in asset [tables](#), The toolbar contains all the editing options of the mini text editor toolbar, plus a clear formatting option.



Plain text editor

The plain text editor allows you to enter text without formatting.

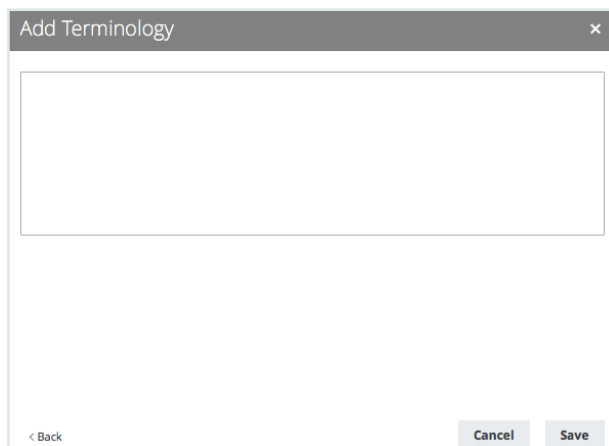

Use of text editors

The following table identifies where the various text editors and field are used.

Editor	Location of use
Standard text editor	<ul style="list-style-type: none"> • Dashboard Text widget • Community, domain and asset pages

Editor	Location of use
Mini text editor	<ul style="list-style-type: none"> • Comments • Ratings
Table text editor	<ul style="list-style-type: none"> • Table text fields
Plain text editor	<ul style="list-style-type: none"> • Add characteristic option of an asset

Keyboard shortcuts

For the standard text editor, you can use the following keyboard shortcuts to edit or format your text:

Action	PC	Mac
Bold	Ctrl + B	Command + B
Italic	Ctrl + I	Command + I
Underline	Ctrl + U	Command + U
Select all	Ctrl + A	Command + A
Redo	Ctrl + Y / Ctrl + Shift + Z	Command + Y / Command + Shift + Z
Undo	Ctrl + Z	Command + Z
Header 1	Alt + Shift + 1	Control + Option + 1
Header 2	Alt + Shift + 2	Control + Option + 2
Header 3	Alt + Shift + 3	Control + Option + 3
Header 4	Alt + Shift + 4	Control + Option + 4

Action	PC	Mac
Header 5	Alt + Shift + 5	Control + Option + 5
Header 6	Alt + Shift+6	Control + Option + 6
Paragraph	Alt + Shift + 7	Control + Option + 7
Keyboard focus to toolbar	Alt + F10	Option + F10
Toggle fullscreen	Alt + Shift + F	Command + Shift + F

Activities

An activity is a process that Collibra runs in the background. While the process is running, you can use Collibra as usual. Activities are, for example, [importing and exporting](#) assets, or [registering](#) a data source and [profiling](#) data.

Activities lists

Activities shows a list of the most recent or ongoing activities in Collibra Data Governance Center. Every time you start a new activity, it is shown in the Activities list.

Activities lists show more information about activities, for example the creation date and the status.

There are two types of Activities lists:

- The Activities list in the main menu: A limited list with only the most recent and ongoing activities.
- The Activities list on your profile page: A list of all activities that you ever started.

Activities list in the main menu

Activities list in the main menu only shows the most recent and ongoing activities. You can open the Activities list in the main menu by clicking . If there are activities still running, the wheel is spinning.

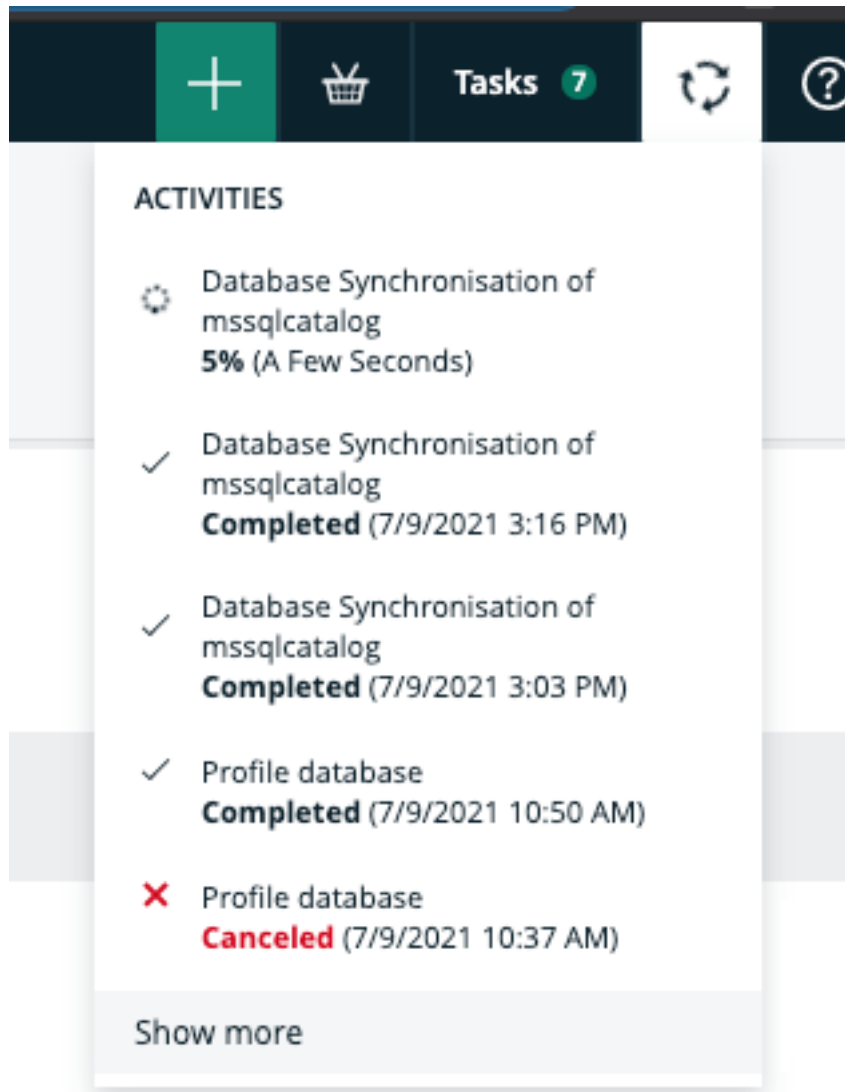

Click **Show more** to go to the Activities list on your profile page.

Activities list on your profile page

The Activities list on your [profile page](#) contains a table with all activities. It also shows more information about each activity, for example the creation date, name, status, start, finish

and result.

You can open the Activities list by clicking **Show more** in the [Activities list on the main menu](#) or by [opening your profile page](#) and clicking the **Activities** tab.

Created	Name	Status	Started	Finished	Results
7/9/2021 10:38 AM	Profile database	Completed	7/9/2021 10:38 AM	7/9/2021 10:50 AM	
7/9/2021 10:31 AM	Profile database	Canceled	7/9/2021 10:31 AM	7/9/2021 10:37 AM	
7/9/2021 10:27 AM	Database Synchronisation of Spark	Completed	7/9/2021 10:27 AM	7/9/2021 10:29 AM	Results
7/9/2021 10:22 AM	Database Synchronisation of Spark	Completed	7/9/2021 10:22 AM	7/9/2021 10:23 AM	Results
7/9/2021 10:15 AM	Profile database	Completed	7/9/2021 10:15 AM	7/9/2021 10:16 AM	
7/9/2021 10:13 AM	Database Synchronisation of Spark	Completed	7/9/2021 10:13 AM	7/9/2021 10:14 AM	Results
7/8/2021 1:16 PM	Bulk synchronize Tableau Sites	Completed	7/8/2021 1:16 PM	7/8/2021 1:16 PM	
7/8/2021 1:15 PM	Bulk synchronize Tableau Sites	Completed	7/8/2021 1:15 PM	7/8/2021 1:16 PM	
7/8/2021 11:48 AM	Updating JDBC schema	Completed	7/8/2021 11:48 AM	7/8/2021 11:49 AM	Results
7/8/2021 11:36 AM	Creating schema from JDBC	Completed	7/8/2021 11:36 AM	7/8/2021 11:37 AM	Results
7/7/2021 5:56 PM	Profile database	Completed	7/7/2021 5:56 PM	7/7/2021 5:56 PM	
7/7/2021 5:53 PM	Database Synchronisation of catalog_po...	Completed	7/7/2021 5:53 PM	7/7/2021 5:54 PM	Results
7/9/2021 2:06 PM	Export to "Business Terms.xlsx".	Completed	7/7/2021 2:06 PM	7/9/2021 2:06 PM	Results
9/25/2019 11:20 AM	Bulk edit Relations	Completed	7/7/2021 11:20 AM	9/25/2019 11:20 AM	

Column	Description
Created	The date and time that you triggered the activity.
Name	The name of the activity.
Status	The status of the activity. The following statuses can be shown: <ul style="list-style-type: none"> • Canceled for canceled activities. • Canceling for activities that are in the process of being canceled. • Completed for completed activities. • Error for failed activities. • Running for activities that are still running. • Waiting for activities that are not started yet.
Started	The date and time that the activity started.
Finished	The date and time that the activity finished.

Column	Description
Results	<p>If available, a button to see the result of the activity. Depending on the activity, the result can be different.</p> <div style="border-left: 2px solid #0070C0; padding-left: 10px; background-color: #F0F0F0;"> <p>Example If you exported assets and click Results in the Activities list, you download the export results. If you registered a data source in Data Catalog, a dialog box shows more information about the registration job.</p> </div>
<Column to delete an activity>	A button () to delete the activity.

Profile page

The profile page of a user contains all relevant information about that user.

As a user, you can only open your own profile page. As an administrator, you can also open other users' profile page.

The view bar contains some basic information about the user, such as the name, license type, required license type and email address.

The profile page contains the following tab pages:

Tab page	Description
Overview	The overview page contains general information such as the user's account information, mail notification settings and contact information.
Groups	The groups page contains the user groups of which the user is a member, and allows you to add the user to or remove the user from groups.

Tab page	Description
Responsibilities	The responsibilities page contains the responsibilities that are assigned to the user.
History	The history page contains the history of the user's actions.
Activities	The activities pages contains the list of your activities .
Mentions	The mentions page contains a list of all comments in which you are mentioned.

Open a profile page

As a regular user, you can open your own profile page. Administrators can open everybody's profile page.

Prerequisites



If you want to open the profile page of another user, you have a [global role](#) with the User Administration or the System Administration [global permission](#), for example Sysadmin.

Open your own profile page

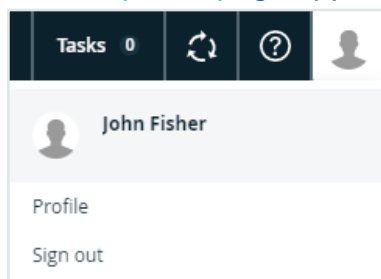
1. Click your avatar, then **Profile**.
» Your [profile page](#) appears.



Open another user's profile page

1. In the main menu, click , then  **Settings**.
 - » The [Collibra DGC settings page](#) opens.
2. Click **Users and groups**.
 - » The [users and groups settings](#) appear on the **Users** tab page.
3. Click the username of the user whose profile you want to open.

Edit the user account settings

As a regular user, you can edit the settings of your own user account on your [profile page](#).
As an administrator, you can also edit other users' settings.

Prerequisites

If you want to edit the user account settings of another user, you have a [global role](#) with the User Administration or the System Administration [global permission](#), for example Sysadmin.

Steps

1. Click your avatar, then **Profile**.
 - » Your [profile page](#) appears.
2. In the **Account** section, click .
3. Enter the required information.

Field	Description
Username	Enter the username. You need administrator permissions to edit the username.
Application Language	Choose the interface language . As an administrator, you can add or edit interface languages .

4. Click **Save**.

Edit the contact information

As a regular user, you can edit contact information of your own user account on your [profile page](#). As an administrator, you can also edit other users' contact information.

Note You can also add new contact information.

Prerequisites

If you want to edit the contact information of another user, you have a [global role](#) with the User Administration or the System Administration [global permission](#), for example Sysadmin.



Edit contact information from a profile page

1. Click your avatar, then **Profile**.
 - » Your [profile page](#) appears.
2. Do one of the following:
 - In the **Contact** section, click  .
Do this to edit the existing fields.
 - In the **Contact** section, click **Add**.
Do this to add a new field, or edit the existing fields.

Note If you edit the email address, a notification email is sent to the old email address.

3. Edit the contact information.
4. Click **Save**.

Edit contact information from the user table

1. In the main menu, click , then  **Settings**.
 - » The [Collibra DGC settings page](#) opens.
2. Click **Users and groups**.
 - » The [users and groups settings](#) appear on the **Users** tab page.

3. Do one of the following:
 - Double-click a cell in the **E-mail** column.
 - Hover your mouse over a cell in the **E-mail** column and click .

Note If you edit the email address, a notification email is sent to the old email address.

4. Click in the field and type the new email address.
5. Click .

Edit the email notification settings

You can edit the email notification settings for your own user account. As an administrator, you can also edit other users' notification settings.

If you enable notifications, you will be notified via email whenever changes are made to assets for which you have been assigned a responsibility.

Note Only the 20 most recent changes for a given asset are shown in the notification email.

Prerequisites

If you want to edit the email notification settings of another user, you have a [global role](#) with the User Administration or the System Administration [global permission](#), for example Sysadmin.

Steps

1. Click your avatar, then **Profile**.
 - » Your [profile page](#) appears.
2. In the **Notifications** section, click .

3. Select or clear the necessary check boxes.

Field	Explanation
Notify me of content updates	Specify whether or not you want to receive email notifications. If you select this option, email notifications will be sent to the email address shown in the Contact section of your Profile page, at the specified frequency.
Days of the week	Receive email notifications only on the days you specify.
Monthly	Receive a summary email once a month.

4. Click **Save**.

Edit the maintenance announcement settings

You can edit the maintenance announcement settings on your [profile page](#).

If you enable maintenance announcements, you receive notifications in Collibra DGC about scheduled maintenance.

Prerequisites

Usage statistics are enabled. Contact [Collibra support](#) if this is not the case.

Steps

1. Click your avatar, then **Profile**.
 - » Your [profile page](#) appears.
2. In the **Scheduled Maintenance Notifications** section, click .
3. Select or clear the check box.
4. Click **Save**.

Edit user details

You can edit your own profile such as the application language, email notifications and contact email address on your [profile page](#). You can also reset your password, you receive instructions to do so by email.

Prerequisites

If you want to edit the user details of another user, you have a [global role](#) with the User Administration or the System Administration [global permission](#), for example Sysadmin.

Steps

1. Click your avatar, then **Profile**.
 - » Your [profile page](#) appears.
2. In the upper-right corner, click **Edit**.
 - » The **Edit** dialog box appears.
3. Enter the required information.

Field	Description
First name	Enter the first name of the user.
Last name	Enter the last name of the user.
Email	Enter the email address on which the user receives all communication from Collibra DGC, such as the registration mail and notifications.
License type	Choose the license type of the user.

4. Click **Save**.

Edit a user's license type

As an administrator, you can edit a user's license type via their [profile page](#) or **Users** tab page.



Prerequisites

If you want to edit the license type of another user, you have a [global role](#) with the User Administration or the System Administration [global permission](#), for example Sysadmin.

Edit a user's license type via the profile page

1. Click your avatar, then **Profile**.
 - » Your [profile page](#) appears.
2. In the upper-right corner, click **Edit**.
 - » The **Edit** dialog box appears.
3. In the **License** field, choose the license type of the user.
4. Click **Save**.

Edit one or more users' license type via the Users tab page

1. In the main menu, click , then  **Settings**.
 - » The [Collibra DGC settings page](#) opens.
2. In the tab pane, click **Users**.
 - » The user table appears.
3. If required, [add the License column](#).
4. [Edit the cells](#) in the **License** column.

Asset functionalities

In this section, you find more information about the general functionalities on asset pages such as diagrams, relations and ratings.

In this chapter



Asset pages

An asset page contains information about one asset. An asset is a resource that is stored and managed in Collibra Data Governance Center and owned or controlled by the customer. An asset is the capital building block by which to capture information (in terms of characteristics).

Identical asset names per domain

'Identical asset names per domain' is a feature that allows you to specify a regular **name** and a unique **full name** for an asset. If 'identical asset names per domain' is enabled for an **asset type**, then multiple assets of that asset type can have an identical name in a domain.

Note All assets must have a unique full name per domain, regardless of whether or not 'identical asset names per domain' is enabled.

Technically, all assets have two names:

- A name: the regular name that is used by default in most places in the UI, such as the asset page title bar, preview panes, diagrams, search results, automatic hyperlinks and relation tables.
- A full name: the fully qualified name that must be unique within a domain. It is mainly used for technical operations (through the API) and when you edit an asset whose asset type allows identical names per domain.

By default, the name of an asset is the same as its full name. Collibra Data Governance Center automatically synchronizes them, so users don't notice the difference. However, for some asset types, it may be beneficial to allow users to edit the name and full name independently of one another, and have multiple assets with an identical name in one domain. This has the following benefits:

- You can use a shorter or simpler name for an asset that has a long or complex full name. This is particularly useful in Collibra Data Catalog.

- You can use the same name for multiple assets in one domain. Keep in mind that the full name still has to be unique for each asset in a domain.

Affected features

- The API is backward-compatible with regard to this feature, meaning the behavior of the API is not affected by whether or not 'identical names per domain' is enabled.
- Drop-down fields
 - In asset drop-down fields, you can search for an asset based on the name or the full name.

This also includes the drop-down menus to:

 - Add manual hyperlinks to an asset in a text attribute.
 - Add (complex) relations on an asset page and in assets table.
 - Filter relations on an asset table.
 - Add data to a data set.
- Tables
 - The **Name** column contains the name. This column cannot be removed because it is used by [hierarchy](#).
 - The **Full name** column is a regular column that is optional.
 - The relation columns contain asset names.
 - You can use both the name and full name as:
 - An advanced filter.
 - A sort option.
 - A column filter.
 - The preview pane shows the asset's name.
 - Editing cells:
 - If the asset type allows identical asset names per domain, you can edit both the name and full name of an asset, independently of one another.
 - If the asset type does not allow identical asset names per domain, editing either the name or full name changes both values.
 - Bulk editing the **Name** and **Full name** column is not possible.
- Tiles
 - The name is used in tile header.
 - **Full name** is a regular field. It can be moved, hidden and you can edit field name.
 - Name and full name are both available as a sort option.

- **Diagrams**
 - The default node name is the asset name. You can also use the full name (or any other property) as node name.
 - You can use **Name** and **Full Name** as a node overlay.
 - The **preview** shows the name of an asset.
- **Export**
 - The name is always exported to the **Name** column.
 - If you select **Add the characteristics needed for reimport:**
 - The full name is always exported (to uniquely identify each asset during re-import).
 - Relations are exported based on the full name: relation name [role/co-role asset type] → Full Name.
 - If you do not select **Add the characteristics needed for reimport:**
 - If the **Full name** column is added to the view, it is exported to the **Full name** column.
 - Relations are exported based on the name: relation name [role/co-role asset type] → Name.
- **Import**
 - Full name has to be mapped, unless you map the 'ID' column (only available in special view 'All Characteristics').
 - Full name will auto-map to the **Full name** column.
 - When you import a file that was exported pre-5.4, you have to manually map the **Full name** column of the view to the **Name** column of the import file.
 - Name will auto-map to the **Name** column.
 - Name does not have to be mapped.
 - Complex relations:
 - Relation asset full name auto-maps to **relation name [role/co-role asset type] → Full Name**.
 - When you import a file that was exported pre-5.4, you have to manually map the **Full name** column of the view to the **relation name [role/co-role asset type] → co-role/role asset type** column of the import file.
 - Relation asset display name should not be mapped.
- **Search**
 - Basic search: searches for assets by name.
 - Advanced search: searches for assets by name, when name is in the search criteria.

- Currently, you can not define a search filter for the ‘full name’ field.
- In the search results, the **Name** column shows the asset name.
- The preview shows the asset name.
- **Validation rules**
 - To refer to the name in your validation rule scripts, use `displayName`.
 - To refer to the full name in validation rule script, use `fullName`.
 - Validation rules are backward compatible with regard to this feature, meaning a validation rule written prior to 5.4, will behave the same in 5.4.

Actions

- Administrators can enable or disable identical asset names per domain for an asset type.

Note If identical asset names per domain has been enabled for an asset type and there are multiple assets in the domain with identical names, the feature can still be disabled. Collibra DGC will simply show the full name of such assets, throughout the UI.

- You can [edit](#) the asset name and full name.
- You can add the **Full name** field to a [table](#) or [tile](#).

Create an asset

In Collibra Data Governance Center, asset types have assigned domain types. You can only add assets to domains whose domain type is assigned to the asset type of the asset.

Steps

1. Open the product for which you want to create the asset, for example the Business Glossary.
2. In the main menu, click the **Create (+)** button.
 - » The **Create** dialog box appears.

3. Click the **Assets** tab.

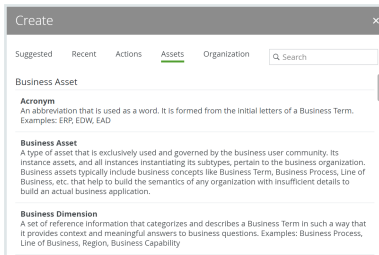

- 4. Click an asset type from the list.
 - » The **Create Asset** dialog box appears.
- 5. Enter the required information.

Field	Description
Type	The asset type of the assets that you are creating.
Domain	The domain to which the new assets will belong. You can only create a asset type in any domain of a domain type that is assigned to a selected asset type.
Name	<p>The names of the new assets.</p> <div style="border: 1px solid #ccc; padding: 10px; margin-top: 10px;"> <p>Tip You can create multiple assets in one go. To do this, press Enter after typing a value and then type the next. Depending on the settings, asset names may have to be unique in their domain. If you type a name that already exists, it will appear in strike-through style.</p> </div>

- 6. Click **Create**.
 - » A message at the top-right of your screen confirms that one or more assets are created.

Asset page overview

The asset page provides an overview of information related to an asset, based on its asset type's assignment. The assignment determines which and how many elements are by default added to the asset page.

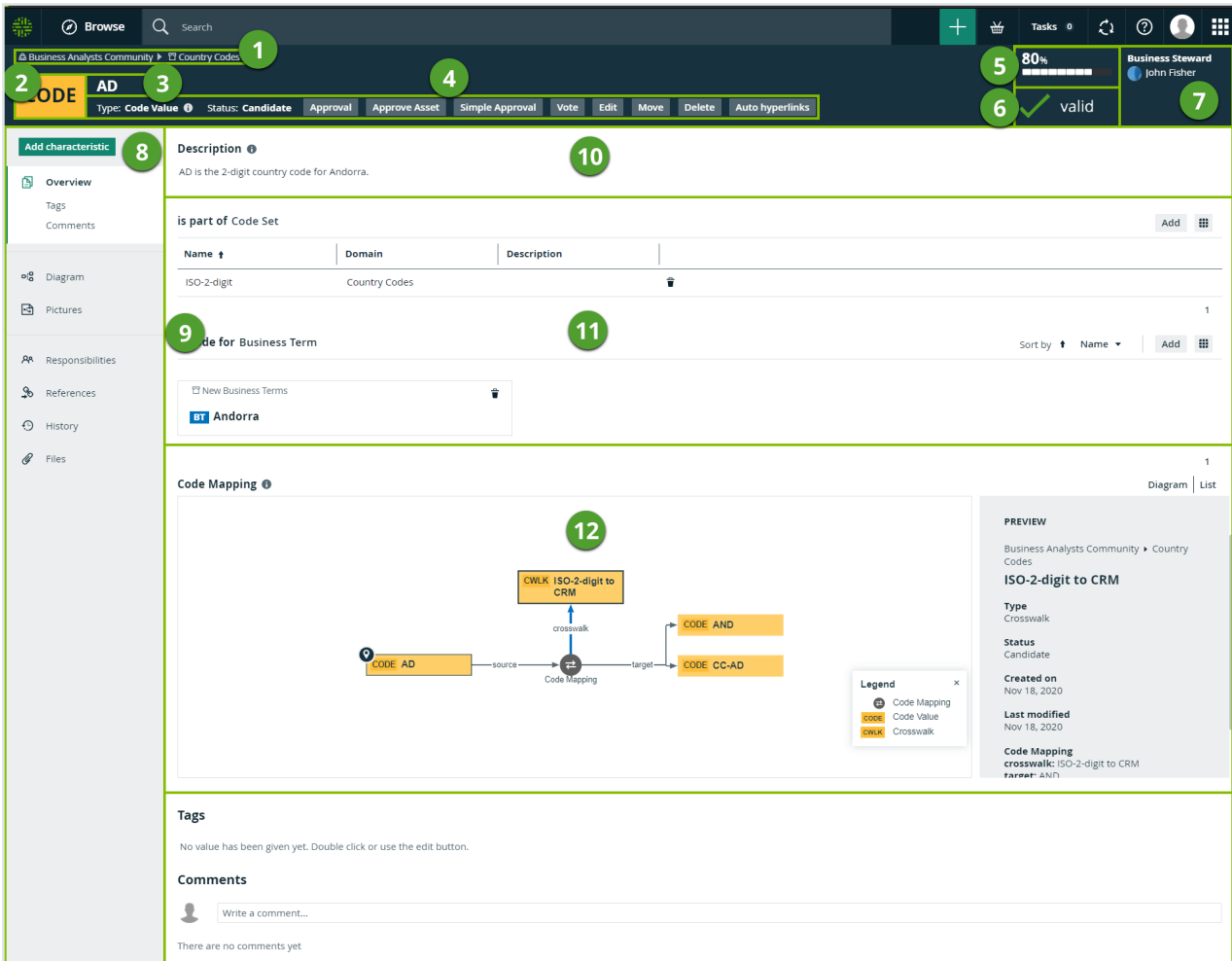

Number	Section	Description
1	Breadcrumbs	The breadcrumbs of the current asset.
2	Asset type representation	The icon or abbreviation of the asset type . <div style="border-left: 2px solid green; padding-left: 10px; margin-left: 20px;"> Tip You can edit how an asset type is represented. </div>
3	Asset name	The name of the asset.
4	Resource toolbar	Additional actions, such as editing the asset and starting a workflow.

Number	Section	Description
5	Articulation score	<p>The articulation score of the asset.</p> <p>Note If there are no articulation score rules assigned to the asset, the asset page does not show an articulation score.</p>
6	Asset validation	The validation result of the validation rules assigned to the asset.
7	Stewards	<p>The stewards of the asset.</p> <p>You can see up to three stewards on the asset page. If there are more, click See all <number> to see them on the Responsibilities page.</p>
8	Tab pane	A collapsible pane that allows you to navigate to other pages of the asset and add characteristics as specified in the assignment.

Number	Section	Description
9	Editor	<p>The currently selected page, in this case the Overview page, which contains all the attributes, relations and complex relations that have been defined for the asset and whose type was added to the relevant assignment.</p> <p>If a certain attribute type has been assigned as mandatory for this asset type, this attribute is shown in the asset's Overview tab, even if no attribute value has been defined yet.</p> <div data-bbox="667 808 1417 1160"><p>Tip If you want to copy and paste text from other sources into a text field, we recommend that you click <code><></code>, and then paste the text into the Show source code field. This will remove any unwanted formatting or tagging of the text. For detailed information, see the knowledge base article on Collibra Support Portal.</p></div>

Number	Section	Description
10	Attribute	<p>An attribute is a characteristic of an asset containing information about the asset. This information can be in various formats, depending on the attribute kind:</p> <ul style="list-style-type: none"> • True/False: A binary choice. • Date: The format of the date depends on the user's locale settings. • Multiple selection: One or more values from a predefined list. • Number: If this is a fraction, the decimal separator shown in the UI is decided by the user's locale settings, usually a comma or a dot. • Selection: One value from of a predefined list. • Text: which may also include images and hyperlinks. <div style="background-color: #f0f0f0; padding: 10px; margin-top: 10px;"> <p>Note If a text attribute does not have any value, it shows the message No value has been given yet. If a text attribute has an empty value, it shows a message Empty value. Text attributes can have up to 100.000 bytes.</p> </div>
11	Relation	<p>Relations of the same type are shown in a list. You can show the list in different display modes:</p> <ul style="list-style-type: none"> • Table: You can also choose the columns, or sort and filter their content. • Tiles: You can choose which fields to display and determine how many tiles to display.

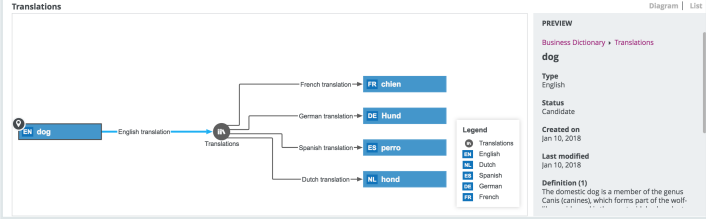
Number	Section	Description
12	Complex relation	<p>Complex relations of the same type can be shown in different ways:</p> <ul style="list-style-type: none"> Table: You can show related assets in a table. This is the default way. You can edit this table in the same way you can any other table. Diagram: You can show complex relations as a diagram to visualize the underlying relations. You can scroll through the diagram and move nodes, but you cannot edit the diagram as extensively as you can via the diagram view. <p>Example</p> 

Relation views

The asset page provides an overview of information related to an asset, based on its asset type's assignment. This includes the **relations** and **complex relations**.

Warning You only see complex relations if you have permission to view all assets of the complex relation.

Display modes

All relations and complex relations of the same type are displayed in a separate section with the relation type as section title. Each section can be shown in different display modes:

- **Table:** By default, related assets are shown in a table. You can **edit** this table in the same way you can any other table.

Example

related to Business Asset			Add ⋮
Name ↑	Asset Type	Status	
Account Effective Date	Business Term	Candidate	🗑️
Account Number	Business Term	Candidate	🗑️
account reference number	Business Term	Candidate	🗑️
account sequence number	Business Term	Candidate	🗑️
Account Status Description	Business Term	Candidate	🗑️
Account Type Code	Business Term	Candidate	🗑️

6

- **Tiles:** You can show the related assets as a set of tiles. You can **edit** this set of tiles in the same way you can any other set of tiles.

Example

related to Business Asset Sort by ↑ Name ▾ | Add ⋮

BT Account Effective Date 🗑️

Candidate

Asset Type
Business Term

BT Account Number 🗑️

Candidate

Asset Type
Business Term

BT account reference number 🗑️

Candidate

Asset Type
Business Term

BT account sequence number 🗑️

Candidate

Asset Type
Business Term

BT Account Status Description 🗑️

Candidate

Asset Type
Business Term

BT Account Type Code 🗑️

Candidate

Asset Type
Business Term

6

- **Diagram:** You can show complex relations as a diagram to visualize the underlying relations. You can scroll through the diagram and move nodes, but you cannot edit the diagram as extensively as you can via the diagram view.

Example

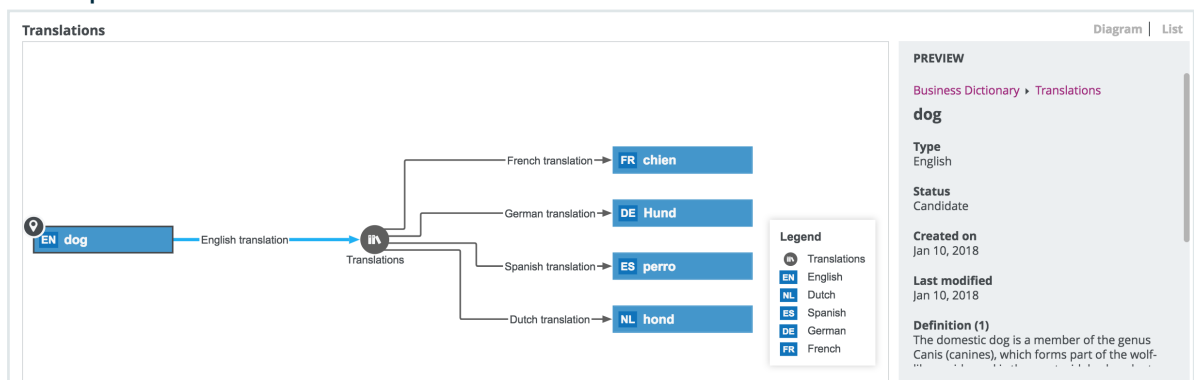

Saving and sharing the layout of relation views

For each relation type and complex relation type, there is a default layout of the relation view. Similar to regular [views](#), you can change most elements of the layout:

- The fields.
- The display mode: table or tiles.
- The sorting and sort direction.
- The tiles or rows per page.
- If the assets are shown in table display mode, the width of each column.

If you make changes, Collibra DGC automatically saves the layout.

If you have the **Manage shared Views, Dashboard and Search Filter** [global permission](#), you can also override the layout of this relation type or complex relation type for all users by clicking  → **Save for all users**. The previous layout of other users is lost. However, all users can still make fresh changes.

Print an asset page or save as a PDF file

You can print an [asset page](#) or save it as a PDF file to share information about an asset outside of Collibra Data Intelligence Cloud, for example for audit, reporting or security purposes.

Note

Not all information is printed:

- Relations are represented by a simple list, with the relation type as the header. Only the names of the related assets are printed in the list. The other fields of the related assets, for example their domains and asset types, are not printed. Additionally, only the related assets of the first page of the relation table are printed. The other related assets are not printed.
- Complex relations are not printed.
- Comments are not printed.
- Attachments are not printed.
- Attributes that were never given a value (except for tags) are not printed.

Steps

1. Open an asset page.
2. In the resource toolbar, click .
- » The print preview and the **Print** dialog box appear.
3. If required, change the print settings, such as the printer or paper size.
4. Depending on your browser and print settings, click **Save** or **Print**.

Edit an asset

You can edit an asset to suit your needs.

Steps

1. Open an asset page.
2. In the resource toolbar, click **Edit**.

3. Enter the required information.

Field	Description
Name	<p>The name of the asset.</p> <p>If identical asset names per domain is disabled for this asset type, the name of an asset must be unique in its domain. If it is disabled and you type an existing name, an error message will appear below this field.</p>
Full name	<p>The full name of the asset. The full name of an asset must always be unique in its domain.</p> <p>This field is only available if identical asset names per domain is enabled for this asset type.</p> <div style="border-left: 2px solid red; padding-left: 10px; background-color: #f0f0f0;"> <p>Warning Do not edit the full name of assets needed to synchronize or refresh data sources. This may cause unexpected results and break the synchronization or refresh process.</p> </div>
Type	The asset type .
Status	The status of the asset.

4. Click **Save**.

Edit the name of an asset

You can edit the name of an asset in different ways:

- From the asset page.
- By [editing](#) the name cell in an asset view.

Tip If [Identical asset names per domain](#) is enabled for the relevant [asset type](#), you can also edit the asset's full name.

Edit the name of an asset from the asset page

1. Open an asset page.
2. In the resource toolbar, click **Edit**.
 - » The **Edit <asset name>** dialog box appears.
3. Enter the required information.

Field	Description
Name	<p>The name of the asset.</p> <p>If identical asset names per domain is disabled for this asset type, the name of an asset must be unique in its domain. If it is disabled and you type an existing name, an error message will appear below this field.</p>
Full name	<p>The full name of the asset. The full name of an asset must always be unique in its domain.</p> <p>This field is only available if identical asset names per domain is enabled for this asset type.</p> <div style="border-left: 2px solid red; padding-left: 10px; margin-top: 10px;"> <p>Warning Do not edit the full name of assets needed to synchronize or refresh data sources. This may cause unexpected results and break the synchronization or refresh process.</p> </div>

4. Click **Save**.

Identical asset names per domain

‘Identical asset names per domain’ is a feature that allows you to specify a regular **name** and a unique **full name** for an asset. If ‘identical asset names per domain’ is enabled for an [asset type](#), then multiple assets of that asset type can have an identical name in a domain.

Note All assets must have a unique full name per domain, regardless of whether or not ‘identical asset names per domain’ is enabled.

Technically, all assets have two names:

- **A name:** the regular name that is used by default in most places in the UI, such as the asset page title bar, preview panes, diagrams, search results, automatic hyperlinks and relation tables.
- **A full name:** the fully qualified name that must be unique within a domain. It is mainly used for technical operations (through the API) and when you edit an asset whose asset type allows identical names per domain.

By default, the name of an asset is the same as its full name. Collibra Data Governance Center automatically synchronizes them, so users don't notice the difference. However, for some asset types, it may be beneficial to allow users to edit the name and full name independently of one another, and have multiple assets with an identical name in one domain. This has the following benefits:

- You can use a shorter or simpler name for an asset that has a long or complex full name. This is particularly useful in Collibra Data Catalog.
- You can use the same name for multiple assets in one domain. Keep in mind that the full name still has to be unique for each asset in a domain.

Affected features

- The API is backward-compatible with regard to this feature, meaning the behavior of the API is not affected by whether or not 'identical names per domain' is enabled.
- Drop-down fields
 - In asset drop-down fields, you can search for an asset based on the name or the full name.

This also includes the drop-down menus to:

 - Add manual hyperlinks to an asset in a text attribute.
 - Add (complex) relations on an asset page and in assets table.
 - Filter relations on an asset table.
 - Add data to a data set.
- **Tables**
 - The **Name** column contains the name. This column cannot be removed because it is used by [hierarchy](#).
 - The **Full name** column is a regular column that is optional.
 - The relation columns contain asset names.

- You can use both the name and full name as:
 - An advanced filter.
 - A sort option.
 - A column filter.
- The preview pane shows the asset's name.
- Editing cells:
 - If the asset type allows identical asset names per domain, you can edit both the name and full name of an asset, independently of one another.
 - If the asset type does not allow identical asset names per domain, editing either the name or full name changes both values.
 - Bulk editing the **Name** and **Full name** column is not possible.
- Tiles
 - The name is used in tile header.
 - **Full name** is a regular field. It can be moved, hidden and you can edit field name.
 - Name and full name are both available as a sort option.
- Diagrams
 - The default node name is the asset name. You can also use the full name (or any other property) as node name.
 - You can use **Name** and **Full Name** as a node overlay.
 - The [preview](#) shows the name of an asset.
- Export
 - The name is always exported to the **Name** column.
 - If you select **Add the characteristics needed for reimport**:
 - The full name is always exported (to uniquely identify each asset during re-import).
 - Relations are exported based on the full name: relation name [role/co-role asset type] → Full Name.
 - If you do not select **Add the characteristics needed for reimport**:
 - If the **Full name** column is added to the view, it is exported to the **Full name** column.
 - Relations are exported based on the name: relation name [role/co-role asset type] → Name.
- Import
 - Full name has to be mapped, unless you map the 'ID' column (only available in special view 'All Characteristics').

- Full name will auto-map to the **Full name** column.
- When you import a file that was exported pre-5.4, you have to manually map the **Full name** column of the view to the **Name** column of the import file.
- Name will auto-map to the **Name** column.
- Name does not have to be mapped.
- Complex relations:
 - Relation asset full name auto-maps to **relation name [role/co-role asset type] → Full Name**.
 - When you import a file that was exported pre-5.4, you have to manually map the **Full name** column of the view to the **relation name [role/co-role asset type] → co-role/role asset type** column of the import file.
 - Relation asset display name should not be mapped.
- **Search**
 - Basic search: searches for assets by name.
 - Advanced search: searches for assets by name, when name is in the search criteria.
 - Currently, you can not define a search filter for the 'full name' field.
 - In the search results, the **Name** column shows the asset name.
 - The preview shows the asset name.
- **Validation rules**
 - To refer to the name in your validation rule scripts, use `displayName`.
 - To refer to the full name in validation rule script, use `fullName`.
 - Validation rules are backward compatible with regard to this feature, meaning a validation rule written prior to 5.4, will behave the same in 5.4.

Actions

- Administrators can enable or disable identical asset names per domain for an asset type.

Note If identical asset names per domain has been enabled for an asset type and there are multiple assets in the domain with identical names, the feature can still be disabled. Colibra DGC will simply show the full name of such assets, throughout the UI.

- You can [edit](#) the asset name and full name.
- You can add the **Full name** field to a [table](#) or [tile](#).

Move an asset to another domain

You can move a single asset to a different domain.

Tip You can also [move](#) multiple assets at once.

Steps

1. Open a table or set of tiles.
2. Click the name of the asset you want to move to another domain.
3. In the subheading, click **Move**.

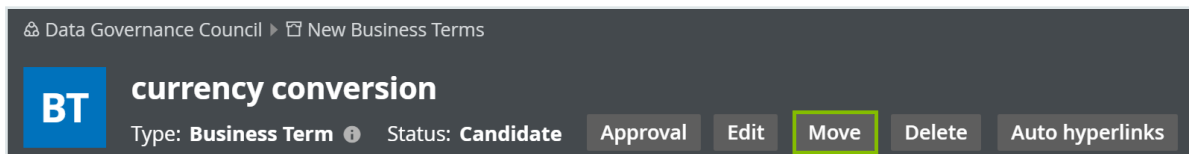

4. In the subheading, click **More** and then select **Move**.

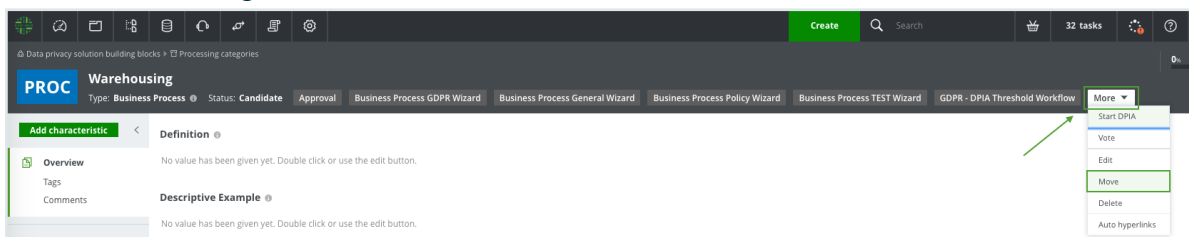

5. In the **Move** dialog box, click the new domain.
6. Click **Save**.

Move multiple assets to another domain

You can move multiple assets to another domain in two ways.

Tip Either way you choose, you can select all the assets on the page at once by clicking the check box next to the **Name** column header.

Note You can only do this if you want to move all assets to the same domain.

Move multiple assets from a domain page

1. Open a domain page.
2. In the tab pane, click **Assets**.
3. Select the the assets you want to move.
4. In the action toolbar, click **Move**.
5. In the **Move selected assets** dialog box, select the new domain.
6. Click **Save**.

Move multiple assets from the global view

1. Open the [global view](#).
2. Select the check boxes in front of the assets you want to move.
3. In the action toolbar, click **Move**.
4. In the **Move selected assets** dialog box, click the new domain.
5. Click **Save**.

Delete an asset

This section describes how to delete an asset in table display mode and tile display mode.

Tip You can also [delete multiple assets](#) at once.

Warning Deletion is permanent, you cannot undo it. If you delete a [configuration asset](#) of a data source, you also delete its configuration. Register your data source again to create a new configuration asset or contact support for more information.

Via an asset page

1. Open an asset page.
2. Do one of the following:
 - In the resource toolbar, click **More > Delete**.
 - In the resource toolbar, click **Actions > Delete**.
3. Click **Delete**.

Delete an asset from a view

In table display mode

1. Open a view in table display mode.
2. If necessary, **filter** using a table filter or a column filter to easily find the asset.
3. Select the check box in front of the asset you want to delete.
4. In the action toolbar, click **Delete**.
 - » The **Delete assets** dialog box appears.
5. Click **Delete**.

In tile display mode

1. Open a view in tile display mode.
2. If necessary, **filter** using a tile filter or a field filter to easily find the asset.
3. Select the tile you want to delete.
4. In the action toolbar, click **Delete**.
 - » The **Delete assets** dialog box appears.
5. Click **Delete**.

Delete multiple assets

This section describes how to delete multiple assets at once, in table display mode and tile display mode.

Note Deletion is permanent, you cannot undo it.

Delete multiple assets in table display mode

1. Open a table.
2. If necessary, **filter** the table using a table filter or a column filter.

3. Select the check boxes in front of the assets you want to delete.

Tip You can select all the visible assets at once by clicking the check box next to the **Name** column header.

4. In the action toolbar, click **Delete**.
 - » The **Delete assets** dialog box appears.
5. Click **Delete**.

Delete multiple assets in tile display mode

1. Open a set of tiles.
2. If necessary, [filter](#) the tiles using a tile filter or a field filter.
3. [Select](#) the tiles you want to delete.
4. In the action toolbar, click **Delete**.
 - » The **Delete assets** dialog box appears.
5. Click **Delete**.

Characteristics

Characteristics is a generic term for [attributes](#), [relations](#) and [complex relations](#).

Add characteristics to an asset

You can add a characteristic to an asset to add additional information about it.

Prerequisite

You have [assigned](#) the characteristic type to the relevant assignment of the asset's type.

Steps

1. Open an asset page.

2. In the tab pane, click **Add Characteristic**.
 - » The **Add a characteristic** dialog box appears.

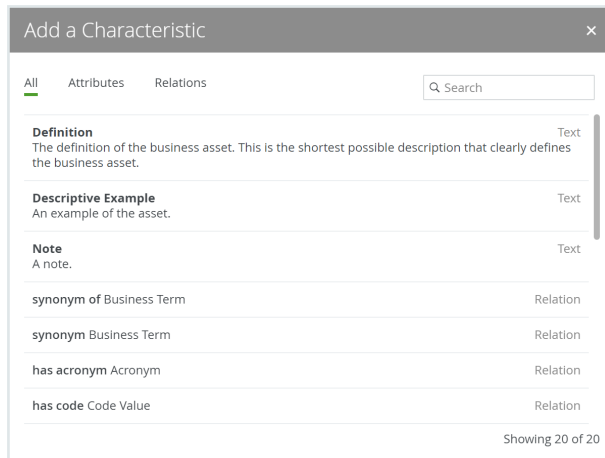

3. In the **Add a Characteristic** dialog box, do one of the following:

If ...	then ...
You want to add an attribute :	Click Attributes .
You want to add a relation :	Click Relations .
You want to filter the characteristics:	<ol style="list-style-type: none"> a. Click All. b. Click in the Search field. c. Start typing the name of the characteristic that you want to add.
<p>Note If the characteristic type is not in the list, it is not in the asset type's assignment.</p>	



4. Enter the required information.

Note The required information depends on the characteristic that you are adding.

5. Click **Save**.

Edit asset characteristics

You can edit characteristics of an asset. The procedure you should follow depends on the [type of characteristic](#) you want to edit.

If ...	then ...
you want to edit an attribute :	<ol style="list-style-type: none"> 1. Open an asset page. 2. Double-click the attribute or click  . 3. Edit the attribute. 4. Click Save.
you want to edit a relation :	<ol style="list-style-type: none"> 1. Delete the existing relation. 2. Create a new relation.
you want to edit a complex relation :	<ol style="list-style-type: none"> 1. Open an asset page. 2. Go to the complex relation you want to edit. 3. Click  to change one of more relations. <ul style="list-style-type: none"> » The Edit Complex Relation dialog box is shown. 4. Edit the content of the complex relation, to meet your needs. <div data-bbox="726 1236 1417 1417" style="border: 1px solid #ccc; padding: 5px; margin: 5px 0;"> <p>Note On the right, the minimum and maximum amount of items that are required are shown.</p> </div> 5. Click Next and then Finish.
<div data-bbox="178 1536 1417 1680" style="border: 1px solid #ccc; padding: 10px;"> <p>Note If the characteristic type is not in the list, it is not in the asset type's assignment.</p> </div>	

Remove asset characteristics

You can remove an asset [characteristic](#) as long as the [minimum number of occurrences](#) in the [assignment](#) has not been reached.

1. Open an asset page.
2. At the end of the line, click .
 - » A dialog box appears.
3. Click **Delete**.

Note These steps can be used to remove attributes, relations or complex relations

Attributes and attribute types

An **attribute** is a characteristic that describes an asset by means of an individual field. The attribute's type defines the class of information that the attribute contains.

About attributes and attribute types

An **attribute** is a characteristic that describes an asset by means of an individual field. The attribute's type defines the class of information that the attribute contains.

You can **add** an attribute to an asset if the attribute's type is in the relevant **assignment** of the **asset's type**.

Examples of attributes and attribute types

The following table contains attribute types and a description of the attribute that can be added to an asset.

Attribute type	Description of the attribute	Example of an attribute
Definition	The description with background information on the asset	Asset: Customer Definition: A person, company or organization that purchases a commodity or service.
Last Review Date	The date on which the asset was reviewed.	02/05/2020

Attribute type	Description of the attribute	Example of an attribute
Frequency	The rate at which an asset changes over a particular period of time.	Daily
Rows Failed	The number of rows that failed a rule.	15
Personally Identifiable Information	A boolean field to indicate whether an asset contains personally identifiable information.	True

Kinds of attribute types

Attribute types can contain different kinds of information, for example, free text, dates and numbers.

Field	Description
Date	<p>A date value. If you edit attributes of this type, you can pick a date using the date selector.</p> <div style="border: 1px solid #ccc; padding: 10px; margin-top: 10px;"> <p>Note The date format that is displayed in the UI, can be different depending on the language settings in your user profile. For example, dd/mm/yyyy or yyyy/mm/dd.</p> </div>
Multiple Selection	A field that allows multiple values that you can select from a predefined list.
with values	The values from which you can select one or more.
Number	A number, or a number with a fraction.

Field	Description
Only integers. (..., -2, -1, 0, 1, 2, ...)	Checkbox to only allow integer numbers. <div style="border: 1px solid #ccc; background-color: #f9f9f9; padding: 5px; margin-top: 10px;"> <p>Note Due to technical limitations, unexpected rounding issues may occur for numbers greater than 9,999,999,999,999,999.</p> </div>
Metric	Checkbox to make this attribute type a metric. This allows you to assign this attribute type as a metric when you create a data quality rule.
Selection	A field that allows a single value that you can select from a predefined list.
with values	The values from which you can select one.
Text	Textual input which may contain formatting.
Plain Text	Checkbox to disable formatting.
True/False	A binary option that allows you to indicate whether something is true or false.
Metric	Checkbox to make this attribute type a metric. This allows you to assign this attribute type as a metric when you create a data quality rule.

Note An attribute can contain up to 100.000 bytes, which corresponds to roughly up to 100 000 characters in the source code of the attribute.

Add an attribute

You can add [attributes](#) to an asset to describe that asset.

Prerequisites

The attribute's type is in the relevant [assignment](#) of the asset's type.

Tip If the minimum cardinality of the relevant attribute type is greater than 0, or if an attribute of that type already exists, the asset page always contains an attribute field for the attribute type.



Add an attribute from an asset page

1. Open an asset page.
2. In the tab pane, click **Add Characteristic**.
 - » The **Add a characteristic** dialog box appears.
3. In the **Add a Characteristic** dialog box, click the **Attributes** tab.
 - » The **Add <attribute type>** dialog box appears.
4. Enter the value of the attribute.

Example If you want to add a Description attribute, enter the description that you want to add to the asset.

5. Click **Save**.

Add an attribute from a table

1. Open a view in table display mode.
2. If required, add the column of the attribute type to the table:
 - a. Above the table, to the right, click  →  **Fields**.
 - b. Click **Select fields** → **Attributes**.
 - c. Select the relevant attribute types.
 - d. Click **Update**.
 - e. Click **Save**.
3. Do one of the following:
 - Double-click a cell.
 - Hover your mouse over a cell and click .
 - » The cell editor appears.

4. Enter the required information.
5. Do one of the following:

If you want to change...	do...
the current row only:	a. Click ✓.
all visible rows:	a. Click Apply to all visible rows . b. Click ✓.
selected rows:	a. Select one or more rows. b. Click Apply to all selected rows . c. Click ✓.

Edit an attribute



You can edit the value of an [attribute](#).

Example You can edit the definition of an asset.



Edit an attribute from the asset page

1. Open an asset page.
2. Double-click the attribute or click .
3. Edit the attribute.
4. Click **Save**.

Edit an attribute from a table

1. Open a view in table display mode.
2. If required, add the column of the attribute type to the table:
 - a. Above the table, to the right, click  →  **Fields**.
 - b. Click **Select fields** → **Attributes**.

- c. Select the relevant attribute types.
 - d. Click **Update**.
 - e. Click **Save**.
3. Do one of the following:
 - Double-click a cell.
 - Hover your mouse over a cell and click .
 » The cell editor appears.
 4. Enter the required information.
 5. Do one of the following:

If you want to change...	do...
the current row only:	a. Click  .
all visible rows:	a. Click Apply to all visible rows . b. Click  .
selected rows:	a. Select one or more rows. b. Click Apply to all selected rows . c. Click  .



Delete an attribute

You can delete [attributes](#) as long as the [minimum number of occurrences](#) has not been reached.

Delete an attribute from an asset page

1. Open an asset page.
2. At the end of the line, click .
 - » A dialog box appears.
3. Click **Delete**.

Delete an attribute from a table

1. Open a view in table display mode.
2. If you don't see the column of the attribute type, add it to the table:
 - a. Above the table, to the right, click  →  **Fields**.
 - b. Click **Select fields** → **Attributes**.
 - c. Select the relevant attributes.
 - d. Click **Update**.
 - e. Click **Save**.
3. Click  next to the attribute that you want to delete.
 - » The **Delete <attribute>** dialog box appears.
4. Click **Yes**.
 - » The attribute field is now empty.

Relations and relation types

A relation is a characteristic that describes how two assets relate to each other. The relation's type defines the relation and determines which assets can be related.

About relations and relation types

A relation is a characteristic that describes how two assets relate to each other. The relation's type defines the relation and determines which assets can be related.

You can [add](#) a relation between assets if the relation's type is in the relevant [assignment](#) of the [asset's type](#).

Elements in a relation type

A relation type has four elements:

Element	Description
Head	Asset type of assets that can be the head of the relation.
Tail	Asset type of assets that can be the tail of the relation.

Element	Description
Role	The description of the relation type going from the head asset to the tail asset.
Co-role	The description of the relation type going from the tail asset to the head asset.

Note Relations are bidirectional. For example, in the relation type "Table is part of/contains Database", the Table asset is part of the Database asset, and the Database asset contains the Table asset.

Add a relation

You can add a [relation](#) to link two assets.

Prerequisites

The relation's type is in the relevant [assignment](#) of the asset's type.

Tip If the minimum cardinality of the relevant relation type is greater than 0, or if a relation of that type already exists, the asset page always contains a relation table for the relation type.

Add a relation from the asset page

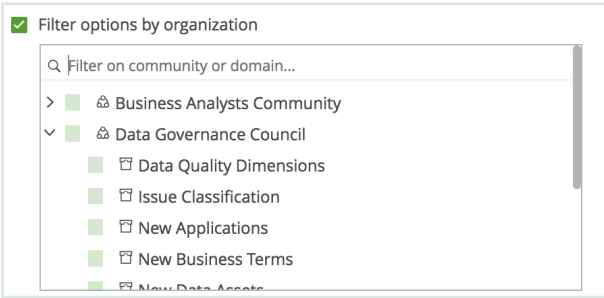

1. Open an asset page.
2. In the tab pane, click **Add Characteristic**.
 - » The **Add a characteristic** dialog box appears.
3. Click **Relations**.
4. Search for and click **<the relation type that you want to create>**.
 - » The **Add relation type <asset type>** dialog box appears.

5. Enter the required information.



Option	Description
Assets	The name of the related asset.
Filter suggested assets by organization	<p>Option to filter the suggestions based on selected communities and domains.</p> <p>If this option is selected, the organization tree appears. You can then filter and select domains and communities.</p> 
Start date	Optionally enter the date on which the relation between the assets becomes applicable.
End date	Optionally enter the date on which the relation between the assets is no longer applicable. Leave this field empty to create a permanent relation.

6. Click **Save**.

Add relations from a table

1. Open a view in table display mode.
2. If you don't see the column of the relation type, add it to the table:
 - a. Above the table, to the right, click  →  **Fields**.
 - b. Click **Select fields** → **Relations**.
 - c. Select the relevant relation types.
 - d. Click **Update**.
 - e. Click **Save**.

3. Do one of the following:
 - Double-click a cell.
 - Hover your mouse over a cell and click .
 » The cell editor appears.
4. Enter one or more assets.
5. Do one of the following:

If you want to change...	do...
the current row only:	a. Click  .
all visible rows:	a. Click Apply to all visible rows . b. Click  .
selected rows:	a. Select one or more rows. b. Click Apply to all selected rows . c. Click  .

Edit a relation

You cannot edit a [relation](#), but you can delete the existing relation and create a new one.

Edit a relation from an asset page

1. **Delete** the existing relation.
 - a. Open an asset page.
 - b. At the end of the line, click .
 - » A dialog box appears.
 - c. Click **Delete**.
2. **Add** a new relation.
 1. Open an asset page.
 2. In the tab pane, click **Add Characteristic**.
 - » The **Add a characteristic** dialog box appears.
 3. Click **Relations**.

4. Search for and click **<the relation type that you want to create>**.
 - » The **Add relation type <asset type>** dialog box appears.
5. Enter the required information.

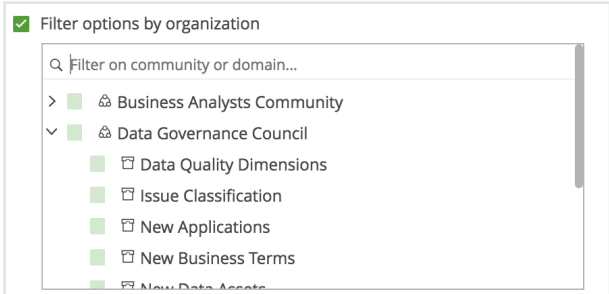

Option	Description
Assets	The name of the related asset.
Filter suggested assets by organization	<p>Option to filter the suggestions based on selected communities and domains.</p> <p>If this option is selected, the organization tree appears. You can then filter and select domains and communities.</p> 
Start date	Optionally enter the date on which the relation between the assets becomes applicable.
End date	Optionally enter the date on which the relation between the assets is no longer applicable. Leave this field empty to create a permanent relation.

6. Click **Save**.

Edit a relation from a table

1. Open a view in table display mode.
2. If required, add the column of the relation type to the table:
 - a. Above the table, to the right, click  → **Fields**.
 - b. Click **Select fields** → **Relations**.
 - c. Select the relevant relation types.

- d. Click **Update**.
 - e. Click **Save**.
3. Do one of the following:
 - Double-click a cell.
 - Hover your mouse over a cell and click .
 » The cell editor appears.
 4. Remove or add one or more assets.
 5. Do one of the following:

If you want to change...	do...
the current row only:	a. Click  .
all visible rows:	a. Click Apply to all visible rows . b. Click  .
selected rows:	a. Select one or more rows. b. Click Apply to all selected rows . c. Click  .

Delete a relation



You can delete [relations](#) between two assets as long as the [minimum number of occurrences](#) in the [assignment](#) has not been reached.



Delete a relation from an asset page

1. Open an asset page.
2. At the end of the line, click .
 - » A dialog box appears.
3. Click **Delete**.

Note If view your relation in tile display mode, the  is in the upper-right corner.

Delete a relation from a table

1. Open a view in table display mode.
2. If you don't see the column of the relation type, add it to the table:
 - a. In the content toolbar, click  →  **Edit Fields**.
 - » The **Fields** dialog box appears.
 - b. Click **Select fields** → **Relations**.
 - c. Select the relevant relation types.
 - d. Click **Update**.
 - e. Click **Save**.
3. Do one of the following:
 - Double-click a cell.
 - Hover your mouse over a cell and click .
 - » The cell editor appears.
4. Remove one or more assets from the cell.
5. Do one of the following:

If you want to change...	do...
the current row only:	a. Click  .
all visible rows:	a. Click Apply to all visible rows . b. Click  .
selected rows:	a. Select one or more rows. b. Click Apply to all selected rows . c. Click  .

Complex relations and complex relation types

A complex relation is a characteristic that describes how two or more assets relate to each other. It can also have attributes of its own, for example, Description and Priority. Technically, they are objectified associations: simplified assets that cannot exist

independently. The complex relation's type defines the relations type and attributes the complex relation can have.

About complex relations and complex relation types

A complex relation is a characteristic that describes how two or more assets relate to each other. It can also have attributes of its own, for example, Description and Priority. Technically, they are objectified associations: simplified assets that cannot exist independently. The complex relation's type defines the relations type and attributes the complex relation can have.

You can [add](#) a complex relation between assets if the complex relation's type is in the relevant [assignment](#) of the [asset's type](#).

Note A complex relation cannot have more than 32 767 relations to assets.

Example

When you [add](#) a complex relation, you add one or more relations between the assets and the complex relation itself. The assets of those relations are always the head of the relation, while the complex relation is always the tail.

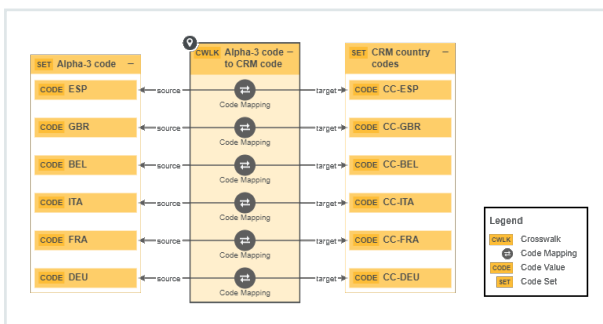

The following example creates a complex relation type called *Code Mapping*, with three relation types (*source*, *target* and *crosswalk*) and two attribute types (*Description* and *Transformation Logic*).

The following example creates a complex relation of the type *Code Mapping*. For each relation type in the complex relation type, you can select head assets. Above the fields, you can see the minimum and maximum occurrences for each relation type. For each selected head asset, a relation of the relevant type is created between the head asset and the complex relation. In a next step, you can add attributes to the complex relation.

Cardinality of relation types and attribute types in complex relation types

With complex relations, you can associate two or more assets in a relation and add attributes to the complex relation. When you [create a complex relation type](#), you set the cardinality of the relation types and attribute types to determine how many relations and attributes you can or must provide when you create a complex relation of that type.

Tip For every complex relation type, at least one relation type must have a minimum cardinality of 1 or greater.

Add a complex relation to an asset

You can add a [complex relation](#) to an asset, to create a link between two or more assets and add attributes.

Tip If you want to add many complex relations, you can also [import](#) them.

Prerequisites

The complex relation's type is in the relevant [assignment](#) of the [asset's type](#).

Tip If the minimum cardinality of the relevant complex relation type is greater than 0, or if a complex relation of that type already exists, the asset page always contains a complex relation table for the complex relation type.

Steps

1. Open an asset page.
2. In the tab pane, click **Add Characteristic**.
 - » The **Add a characteristic** dialog box appears.
3. In the **Add a Characteristic** dialog box, click the **Relations** tab
4. Select a relation of the type **Complex Relation**, for example, *Field Mapping Target*.
 - » The **Add <complex relation type>** dialog box appears.
5. Enter the required information.

The required fields depend on the configuration of the complex relation type.

Tip The minimum and maximum amount of assets that you can add is displayed in the right upper corner of every relation field. If there is no maximum amount, the maximum amount of assets to add in the relation was not set.

6. Click **Next**.
7. Depending on the selected complex relation type, fill in the necessary information.
8. Click **Finish**.

Edit a complex relation

You can edit a [complex relation](#), for example if you want to edit its legs or attributes.

Steps

1. Open an asset page.
2. Find the complex relation you want to edit.
3. Click  to change one of more relations or attributes.
 - » The **Edit Complex Relation** dialog box appears.
4. Enter the required information.

The required fields depend on the [configuration](#) of the complex relation type.
5. Click **Next**.
6. Depending on the selected complex relation type, enter in the necessary information.
7. Click **Save**.

Delete a complex relation

You can delete a [complex relation](#) between two or more assets as long as the [minimum number of occurrences](#) in the [assignment](#) has not been reached.

Steps

1. Open an asset page.
2. At the end of the line, click .
- » A dialog box appears.
3. Click **Delete**.
- » The complex relation is deleted.

Hyperlinking

In Collibra Data Governance Center, you can manually create hyperlinks in text attributes or enable automatic hyperlinking to easily navigate from asset to asset or from an asset to a website.

Automatic hyperlinking

In Collibra DGC, every asset is a potential "target" of a hyperlink. If the name of an asset is mentioned somewhere in a text attribute of another asset, that mention automatically gets a hyperlink to the corresponding asset. Collibra DGC keeps all hyperlinks up to date when you edit your data.

You can enable or disable automatic hyperlinking at the different levels:

- **Environment:** Contact [Collibra support](#) if you want to enable or disable automatic hyperlinking in your entire environment.
- **Domain:** If automatic hyperlinking is enabled in Collibra Console, you can enable or disable it on the domain level. Because every asset is a possible target, automatic hyperlinking can lead to an excessive amount of hyperlinks, which can negatively affect performance. Therefore, by default, automatic hyperlinking is disabled for all domains. However, you can enable it.

- **Individual assets:** An asset may have a common word as its name, for example, "is", "a", "or" or "and". When that happens, you don't want hyperlinks to this asset because it would lead to a lot of useless hyperlinks. Therefore, you can exclude such assets from automatic hyperlinking.

Note If there are assets with identical names, they are all shown in a pop-up when you click the link. Then, you can click one to open its asset page.

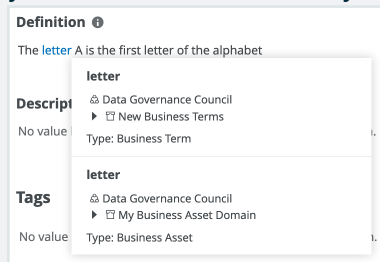

After importing data or after a backup has been restored, Collibra DGC triggers a rebuild of the automatic hyperlinks. You can also [rebuild](#) the hyperlinks manually.

Tip By default, automatic hyperlinking is not case sensitive. For example, an asset 'Nato' will also be hyperlinked if it is mentioned as 'NATO', and vice versa. Contact [Collibra support](#) to change case-sensitivity for automatic hyperlinking.

Manual hyperlinking

You can use manual hyperlink if you want a hyperlink to or from a specific asset. This is particularly useful if automatic hyperlinking is disabled, or if the link text does not match the name of the target asset.

Tip You can also manually [create](#) hyperlinks to web addresses.

Disable automatic hyperlinking to a specific asset

You can disable [automatic hyperlinking](#) at [domain level](#) and asset level.

Contact [Collibra support](#) if you want to enable or disable automatic hyperlinking for your entire environment.

An asset may have a common word as its name, for example, "is", "a", "or" or "and". When that happens, you don't want hyperlinks to this asset because it would lead to a lot of useless hyperlinks.

You can still [manually create hyperlinks](#) that target the asset.

Steps

1. Open an asset page.
2. In the toolbar, click, **Auto hyperlinks**.
 - » The **Auto hyperlinks** dialog box appears.
3. Enter the required information.

Field	Description
No Automatic Hyperlink	Collibra Data Governance Center will not create automatic hyperlinks to this asset.

4. Click **✕** to close the dialog box.

What's next?

All automatic hyperlinks to the asset are removed and Collibra Data Governance Center no longer creates automatic hyperlinks to the asset.

If you enable automatic hyperlinking to the specific asset again, you have to [rebuild](#) the hyperlinks.

Enable automatic hyperlinking in a domain

[Automatic hyperlinking](#) is especially useful for linking to Business Term assets. But as every asset is a possible target, automatic hyperlinking can lead to an excessive amount of hyperlinks, which can negatively affect performance. Therefore, by default, automatic hyperlinking is disabled for all domains.

Nevertheless, you can enable automatic hyperlinking at the domain level.

Tip You can use the [Manage auto hyperlinks workflow](#) to enable or disable automatic hyperlinking in bulk.

Prerequisites

Automatic hyperlinking is enabled. Contact [Collibra support](#) if this is not the case.

Steps

1. Go to the domain page of the domain for which you want to enable automatic hyperlinking.
2. In the toolbar, click **Auto hyperlinks**.
 - » The **Auto hyperlinks** dialog box appears.
3. Enter the required information.

Field	Description
No Automatic Hyperlink	Collibra DGC will not create automatic hyperlinks to assets in this domain when its name occurs in a text attribute of another asset. You can use this option when the asset name is a common word like 'and', 'or', 'it', etc. You can still create manual hyperlinks to this asset.

4. Click **✕** to close the dialog box.



What's next?

[Rebuild the hyperlinks](#) to automatically create the hyperlinks to all the assets in the domain.

Delete an automatic hyperlink

Collibra Data Governance Center can [automatically create hyperlinks](#) to assets. However, you can delete some or all of the hyperlinks without touching other potential automatic hyperlinks to the destination asset.

Steps

1. Open an asset page.
2. Click  in the text field with an automatic hyperlink.
3. Select the text.
4. In the **Edit** toolbar, click  (**Remove autohyperlink**).
 - » The hyperlink is removed.
5. Click **Save**, to save the content of the text field.

What's next?

The automatic hyperlink is removed, but if you edit the text field again and you add the same text, the automatic hyperlink will again be created. If [the hyperlinks are rebuilt](#), for example after restoring a backup, the hyperlinks may reappear.

Tip To prevent an automatic hyperlink to a specific asset, you have to [disable automatic hyperlinking](#) for the target asset or the domain of the target asset.

Create a hyperlink to an asset

You can manually create [hyperlinks](#) to assets.

Tip Collibra Data Governance Center can also [create hyperlinks automatically](#).

Steps

1. Open an asset page.
2. Double-click a text attribute, for example the definition, to edit the text.
3. Select the text to transform into a hyperlink.
4. On the **Edit** toolbar, click  (**Insert/edit link**) → **Link to asset**.
5. In the **Assets** field, start typing the name of the asset to which you want to link. The assets are filtered as you type.

Tip To help you identify the correct asset, the domain of each asset is shown below the asset name.

6. Click the asset to which you want to link.

Note You can link to multiple assets, in which case, all links are shown when you click the link. You can then select which one to follow.

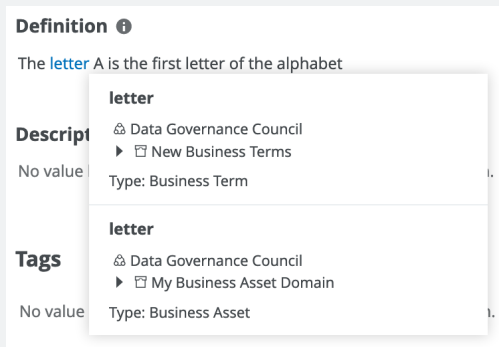



7. Click **Save**, to save the hyperlink.
8. Click **Save**, to save the content of the text field.

Create a hyperlink to a web address

In addition to [creating hyperlinks to other assets](#) in your environment, you can also create hyperlinks to web addresses. When you click the [hyperlink](#), it will automatically open in a new tab.

Steps

1. Open an asset page.
2. Double-click a text attribute or click  to edit the text.
3. Select the text to transform into a hyperlink.
4. On the **Edit** toolbar, click  (**Insert/edit link**) → **Link to URL**.

5. Enter the required information.

Setting	Description
URL	<p>The target website of the hyperlink.</p> <p>If you don't start the URL with <code>http://</code> or <code>https://</code>, the system will ask if it has to add <code>http://</code>. If you don't add either prefix, Collibra Data Governance Center will consider the URL content an asset.</p> <div style="border: 1px solid #ccc; padding: 5px; margin-top: 10px;"> <p>Note You will only see this field if the hyperlink you edit is a link to a URL.</p> </div>
Text to display	The display text that will be visible in the attribute. By default, this is the text that you selected.

6. Click **Save**, to save the hyperlink.
7. Optionally, edit the source code so that the hyperlink automatically opens in a new tab when you click it.
 - a. Click **Source code** (↔).
 - b. Type `target = "_blank"` after the href attribute.

Example Click `here` for more information.

- c. Click **Save**.
8. Click **Save**.

Edit a manually created hyperlink

After you have created a [hyperlink](#), you can always edit it afterwards.

Note Automatic hyperlinks cannot be edited.

Steps

1. Open an asset page.
2. Double-click a text attribute or click  in the text field that contains the hyperlink that you want to edit.
3. Click anywhere on the hyperlinked text and click **Edit**.
4. Update the link:
 - a. Enter the required information.

Field	Description
URL	<p>The target website of the hyperlink.</p> <p>If you don't start the URL with <code>http://</code> or <code>https://</code>, the system will ask if it has to add <code>http://</code>. If you don't add either prefix, Collibra Data Governance Center will consider the URL content an asset.</p> <div style="background-color: #f0f0f0; padding: 10px; border: 1px solid #ccc;"> <p>Note You will only see this field if the hyperlink you edit is a link to a URL.</p> </div>
Assets	<p>The target assets of the hyperlink.</p> <p>The assets are filtered as you type. Click the asset to which you want to link.</p> <div style="background-color: #f0f0f0; padding: 10px; border: 1px solid #ccc;"> <p>Note You will only see this field if the hyperlink edit is a link to an asset.</p> </div>
Text to display	<p>The display text that will be visible in the attribute. By default, this is the text that you selected.</p>

- b. Click **Save**.
5. Click **Save**.

Remove a manually created hyperlink

You can remove [manually created hyperlinks](#) in text attributes.

Steps

1. Open an asset page.
2. Click  in the text field that contains the hyperlink that you want to remove.
3. Click anywhere on the hyperlinked text and click **Unlink**.
 - » The hyperlink is removed. If the hyperlink pointed to many assets, all links are removed.
4. Click **Save**, to save the content of the text field.

Ratings

Ratings enable users to subjectively rate the quality of an asset, using a five-star rating system, and write a free-text review of the asset, in support of the rating provided.

Unlike objective parameters such as data quality, certifications and articulation scores, ratings are purely subjective assessments of data quality.

Enabling ratings

Ratings are **enabled** by **asset type**. When ratings are enabled for a particular asset type, users can **rate** any asset of that asset type.

Permissions

No particular **license** is needed to rate assets or to edit or delete ratings; however, certain **resource permissions** are needed.

Permission	With this resource permission, you can...
Rating > Add	<ul style="list-style-type: none"> • Rate any asset of an asset type for which the feature is enabled. • Edit or delete your own ratings.
Rating > Modify	<ul style="list-style-type: none"> • Edit other users' ratings.
Rating > Remove	<ul style="list-style-type: none"> • Delete other users' ratings.

Note

- Users are not granted permissions directly, but through global roles and responsibilities.
- Guest users can see all ratings and reviews, but cannot provide ratings or reviews of their own.
- Adding, editing and removing ratings doesn't change assets, so their last modified date will not be updated.

Actions

- [View ratings](#).
- [Enable or disable ratings](#).
- [Rate an asset](#).
- [Edit a ratings](#).
- [Delete a rating](#).
- [Delete all ratings](#) of assets of a specific type.

Enable or disable ratings

You can enable and disable [ratings](#) via the [asset type](#) pages, in  **Settings**.

Enabling ratings for a particular asset type is not inherited by children asset types. The feature has to be manually enabled for each child asset type.



By default, ratings are enabled for asset types **Data Set** and **Report** and their children asset types. Ratings are disabled, by default, for all other packaged asset types and any asset types you create.

Warning Ratings cannot be disabled for a specific asset type if user ratings exist for any assets of that asset type. In other words, all user ratings for all assets of a specific asset type must be manually [deleted](#) before ratings can be disabled for that asset type.

Prerequisites

You have a [global role](#) that has the System administration [global permission](#).

Steps

1. Open an asset type.
 - a. In the main menu, click , then  **Settings**.
 - » The [Collibra DGC settings page](#) opens.
 - b. Click **Operating Model**.
 - » The [operating model settings](#) appear on the **Asset types** tab page.
 - c. In the overview of asset types, click an asset type.
 - » The **Asset type** editor opens.
2. In the upper-right corner, click **Edit**.
 - » The **Edit <asset type>** dialog box appears.
3. Enter the required information.

Field	Description
Enable ratings	Select to allow users to rate assets. Ratings enable users to subjectively rate the quality of an asset, using a five-star rating system, and write a free-text review of the asset, in support of the rating provided.

4. Click **Save**.

View ratings

If [ratings](#) are enabled for an [asset type](#) and one or more ratings has been provided for an asset of that type, the associated ratings activity appears in several places in the UI.

On an asset page

Ratings information appears on the asset page of any asset with one or more ratings.

April sales figures
 ★★★★★ (201) | Type: Data Set | Status: Candidate | Approval | Simple Approval | Edit | Move | Delete

1 Add characteristic **2**

Tags
 No value has been given yet. Double click or use the edit button.

Details
 Data Profiling
 Sample data
 Tags
Ratings
 Comments

Ratings
3.2 Stars (201 Ratings) **2**

5 ★	22%
4 ★	25%
3 ★	19%
2 ★	17%
1 ★	16%

3 **4**

My rating **5**
 ★★★★★ Good
 Good work here!

6

Admin Istrator
 ★★★★★
 Good work here!

Bill Johnson
 ★★★★★
 Accurate and complete.







Rohit Martin
 ★☆☆☆☆
 This description ignores a key concept.

No.	Description
1	The average of all user ratings for that asset.
2	The total number of ratings.
3	A horizontal bar chart showing the distribution of ratings.
4	The percentage of total votes per number of stars.
5	Your rating and review.
6	Other users' ratings and reviews, ordered from newest to oldest.

In the History tab

User ratings and any edits to, or deletions of, ratings are shown in the [History tab page](#) of the relevant:

- Asset pages.
- User profiles.
- Community pages.
- Domain pages.

History				
	Rating ★★★★★ This data set is very complete and the data is up-to-date with latest information	 Small and medium-sized...	 William Parker	1/10/2018 10:56 PM
	Rating ★★★★★ This data set is very complete	 Small and medium-sized...	 William Parker	1/10/2018 3:58 PM

In an asset table or set of tiles

There are two fields related to ratings that can be shown in an asset table or set of tiles:

- **Average rating:** The average of all user ratings for each asset.
- **Number of ratings:** The total number of ratings for each asset.

You can [sort](#) on these two fields and [filter](#) them.

All assets ▾					
View for displaying all assets					
Delete Move Validate					
Name ↑	Number of ratings	Average Rating	Status	Asset Type	
11 Data Set	40	★★★★☆	Candidate	Data Set	
1 Data Set	40	★★★★☆	Candidate	Data Set	
2 Data Set	1	★★★☆☆	Candidate	Data Set	
3 Data Set	1	★★★★☆	Candidate	Data Set	
4 Data Set	200	★★★★☆	Candidate	Data Set	
4 Data Set 2	1	★★★★☆	Candidate	Data Set	

Rate an asset

You can rate any asset of an [asset type](#) for which [ratings](#) have been enabled.

Ratings can only be given via asset pages.

You can [edit](#) or [delete](#) your ratings at any time.

Steps

1. Open an asset page.
2. In the **My rating** section, click the star that corresponds most closely to your opinion of the quality level of the asset.
The rating range is from one to five stars, with five representing the highest level of quality and one representing the lowest.
3. Optionally, enter a review of the asset in the text field.

Tip This collaborative feature is intended to help an organization improve the quality of its data and help users trust the quality of the data. As such, if you provide a rating of three stars or fewer, we strongly encourage you to provide a review, to help the owner understand how the quality of the asset might be improved.

4. Click **Save**.
 - » The average user rating is recalculated.

Edit a rating

If, for any reason, your opinion of the quality of an asset changes, you can edit or [delete](#) the [ratings](#) you've given, at any time. With the correct [resource permissions](#), you can also edit other users' ratings.

Steps



1. Open an asset page.
2. If required, edit your own :
 - a. In the **My rating** section, click .
 - b. Make the necessary changes:
 - Click the star that corresponds most closely to your opinion of the quality level of the asset.
 - Edit your review, if relevant.
 - c. Click **Save**.
 - » The average user rating is recalculated.

3. If required, edit another user's rating:
 - a. In the **Rating** section, click  next to the rating you want to edit.
 - b. Make the necessary changes:
 - Click the star that corresponds most closely to the other user's opinion of the quality level of the asset.
 - Edit the review, if relevant.
 - c. Click **Save**.
 - » The average user rating is recalculated.

Delete a rating

If, for any reason, your opinion of the quality of an asset changes, you can [edit](#) or delete the [ratings](#) you've given, at any time. With the correct [resource permissions](#), you can also delete other users' ratings. This can be helpful if one or more previous ratings and reviews are no longer relevant.

Steps

1. Open an asset page.
2. If required, delete your own rating:
 - a. In the **My rating** section, click .
 - b. Click **Delete**, to confirm.
 - » The average user rating is recalculated.
3. If required, delete another user's rating:
 - a. In the **Ratings** section, click  next to the rating you want to delete.
 - b. Click **Delete**, to confirm.
 - » The average user rating is recalculated.



Delete all ratings

You can delete all [ratings](#) of all assets of an [asset type](#) in one go. This is mainly helpful if you want to [disable ratings for that asset type](#).

Prerequisites

You have a [global role](#) that has the System administration [global permission](#).

Steps

1. Open an asset type.
 - a. In the main menu, click , then  **Settings**.
 - » The [Collibra DGC settings page](#) opens.
 - b. Click **Operating Model**.
 - » The [operating model settings](#) appear on the **Asset types** tab page.
 - c. In the overview of asset types, click an asset type.
 - » The **Asset type** editor opens.
2. In the upper-right corner, click **Delete ratings**.
 - » The **Confirm deletion** dialog box appears.
3. Click **Delete ratings**.

Asset tags

To categorize assets, you do not only have strictly governed metadata, but you also have tags, which are labels of your own choice.

In this section, you learn more about tags and how you manage them.

Tags

A tag is a piece of metadata that is used to label an asset, to help categorize the asset. You can use the same tag for all the assets that belong to the same category of a business, for example, finance. Although the tags are stored in the Collibra Data Governance Center database, they are not strictly governed by Collibra DGC.

You can:

- Search for assets with a specific tag by clicking the tag on an [asset page](#) or on the [tags overview page](#).
- Select the Tag facet on the [Search page](#), to navigate search results.

- Use tags in filter clauses.
- Import and export tags.

Note

- You can only add tags to assets, not to domains or communities.
- Adding, editing and removing tags doesn't change assets, so their last modified date will not be updated.

Tag names

Tag names must meet the following requirements:

- Tag names are case sensitive.
For example, you can have the tag names *Car* and *car*. However, the tag suggestion is not case sensitive, for example, typing *car* suggests both "Car" and "car".
- Tag names cannot contain spaces.
- Underscore (`_`) is allowed.

Note If you upgrade to 5.6 or newer, spaces in tags are automatically replaced by underscores. Possible duplicate tags due to this renaming, will be merged.

- The maximum length of the tag name is 250 characters.

Permissions

The following table shows the permissions you need to manage tags:

- On asset pages.
- On the tags overview page.

Page	Permission	
Asset page	Resource	<p>Update: Add and remove tags.</p> <p>To grant this permission to a role, see Enable permission to use tags.</p> <div style="border: 1px solid #ccc; padding: 10px; background-color: #f9f9f9;"> <p>Note The role to which you grant this permission needs at least view access to the corresponding asset type. See Responsibilities.</p> </div>
Tags overview page	Global	<p>Manage tags: Edit, merge and delete tags. This permission allows admin and super users to manage all tags.</p> <p>View tags: View the tags overview page.</p>

Tags overview page

The tags overview page provides an overview of all the [tags](#) in Collibra Data Governance Center.

With the right [permissions](#), you can view, [delete](#), [edit](#), and [merge](#) tags.

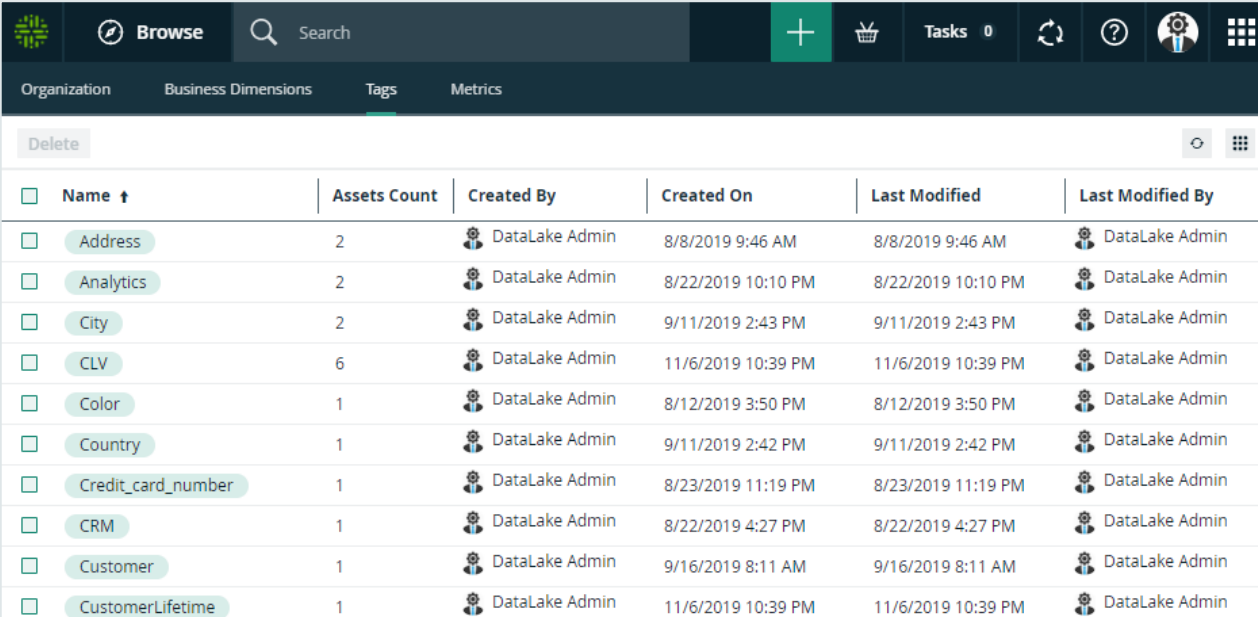

<input type="checkbox"/>	Name ↑	Assets Count	Created By	Created On	Last Modified	Last Modified By
<input type="checkbox"/>	Address	2	DataLake Admin	8/8/2019 9:46 AM	8/8/2019 9:46 AM	DataLake Admin
<input type="checkbox"/>	Analytics	2	DataLake Admin	8/22/2019 10:10 PM	8/22/2019 10:10 PM	DataLake Admin
<input type="checkbox"/>	City	2	DataLake Admin	9/11/2019 2:43 PM	9/11/2019 2:43 PM	DataLake Admin
<input type="checkbox"/>	CLV	6	DataLake Admin	11/6/2019 10:39 PM	11/6/2019 10:39 PM	DataLake Admin
<input type="checkbox"/>	Color	1	DataLake Admin	8/12/2019 3:50 PM	8/12/2019 3:50 PM	DataLake Admin
<input type="checkbox"/>	Country	1	DataLake Admin	9/11/2019 2:42 PM	9/11/2019 2:42 PM	DataLake Admin
<input type="checkbox"/>	Credit_card_number	1	DataLake Admin	8/23/2019 11:19 PM	8/23/2019 11:19 PM	DataLake Admin
<input type="checkbox"/>	CRM	1	DataLake Admin	8/22/2019 4:27 PM	8/22/2019 4:27 PM	DataLake Admin
<input type="checkbox"/>	Customer	1	DataLake Admin	9/16/2019 8:11 AM	9/16/2019 8:11 AM	DataLake Admin
<input type="checkbox"/>	CustomerLifetime	1	DataLake Admin	11/6/2019 10:39 PM	11/6/2019 10:39 PM	DataLake Admin

By default, the tags table shows the **Name** column and the **Created By** column. You can [add](#) more columns. The following table describes all available columns.

Column	Description
Assets Count	Total number of assets to which a specific tag has been applied.
Created By	The user who created the tag.
Created On	The date on which the tag was created.
Last Modified	The date and time when the tag was last modified.
Last Modified By	The user who last modified the tag.
Name	Name of the tag. Tag names cannot contain spaces and the maximum length is 250 characters. The underscore (_) character is allowed.



Search by tags



You can search for all assets for which a specific tag has been applied, by clicking the tag [on an asset page](#) or the [tags overview page](#). The search results are shown on the [Search page](#).

Edit a tag on the tags overview page

If you have the correct [resource permission](#), you can edit an existing tag on the [tags overview page](#).

Steps





1. In the main menu, click , then  **Stewardship**.
2. In the submenu, click **Tags**.
 - » The **Tags** overview page opens.
3. Hover your mouse over the name of a tag.

4. Click edit  to the right of the tag name.
5. Edit the name.
6. Click .

Merge tags on the tags overview page

You can merge tags on the [tags overview page](#). You merge tags by changing the name of a tag to that of another existing tag.



Steps

1. In the main menu, click , then  **Stewardship**.
2. In the submenu, click **Tags**.
 - » The **Tags** overview page opens.
3. Hover your mouse over the name of a tag.
4. Click edit  to the right of the tag name.
5. Change the name of the tag to that of another existing tag.
6. Click  to the right of the tag.
 - » The **Merge tags confirmation** dialog box appears.
7. Click **Merge**.

Delete a tag from the tags overview page

You can delete one or more tags from the [tags overview page](#).

Steps

1. In the main menu, click , then  **Stewardship**.
2. In the submenu, click **Tags**.
 - » The **Tags** overview page opens.
3. Select the checkboxes to the left of the tags you want to delete.
4. In the resource toolbar, click **More > Delete**.

Add a tag to an asset on an asset page

You can add a [tag](#) to an asset on an [asset page](#).

Steps

1. Open an asset page.
2. Double-click in the **Tags** section, or click  on the right-hand side of the section.
3. Type the text for your tag and press `Enter`.

Tip

- As you type, already existing tags that match what you are typing are suggested. If you want to use a suggested tag, you can click on it. Otherwise, you can ignore the suggestions.
- You can add as many tags as you want.

4. Click **Save**.

Add a tag to an asset in an asset table or set of tiles

You can add a [tag](#) to an asset in a table.

Steps

1. Open any set of assets in table [display mode](#).
2. Double-click in the **Tags** column, or click  on the right-hand side of that column.
If you do not see the **Tags** column, add it to the table. See [Customizing tables](#).
3. Type the text for your tag and press `Enter`.

Tip



- As you type, already existing tags that match what you are typing are suggested. If you want to use a suggested tag, you can click on it. Otherwise, you can ignore the suggestions.
- You can add as many tags as you want.

4. Click .

Delete a tag from an asset on an asset page

You can delete a tag from an asset on an asset page.



Steps

1. Open an asset page.
2. Double-click in the **Tags** section, or click  on the right-hand side of the section.
3. Click  next to the tags that you want to delete.
4. Click **Save**.

Delete a tag from an asset in an asset table

You can delete a tag from an asset in an asset table.

Steps

1. Open any set of assets in table [display mode](#).
2. Double-click in the **Tags** column, or click  on the right-hand side of that column.
If you do not see the **Tags** column, add it to the table. See [Customizing tables](#).
3. Click  next to the tags that you want to delete.
If you want to delete the tags from all assets that are visible on the page, select the **Apply to all visible rows** check box.
4. Click .

Comments and attachments

You can add comments and attachments to communities, domains and assets. Examples of attachments are reference materials or other documents that are related to the resource.

Attachments

An attachment is a file that you upload via an asset page, domain page or community page. You can use this to add reference materials or other documents that are related to the resource.

You can find attachments on the community, asset or domain page → **Files**.

File Name	Type	Uploaded by	Uploaded on
All data (1).xlsx	Excel Sheet (xlsx)	Admin Istrator	6/9/17

Note

- Adding and removing attachments doesn't modify assets, so their last modified date will not be updated.
- Uploading attachments is restricted by the file upload settings, which determine the maximum file size, allowed file extensions and maximum amount of uploads and downloads per day. Contact [Collibra support](#) if you want to change the file upload settings.

Add attachments

You can add files to an asset, domain or community as [attachments](#).

Note

- Adding and removing attachments doesn't change assets, so their last modified date will not be updated.
- Uploading attachments is restricted by the file upload settings, which determine the maximum file size, allowed file extensions and maximum amount of uploads and downloads per day. Contact [Collibra support](#) if you want to change the file upload settings.

Steps

1. Open a community, domain or asset page.
 2. In the tab pane, click **Files**.
 3. Upload a file in one of the following ways:
 - Drag and drop the file in the upload area.
 - Click **Upload a file**, browse to the location of the file and click **Open**.
- » The file is displayed in the table.

Comments

You can add comments to communities, domains and assets. For example, you can discuss the attributes or propose related assets.

Comments

You can find comments on the community, asset or domain page → **Overview** or **Details** tab → **Comments**.

Next to adding comments, you can also reply to other comments (■), edit your own comments (✎) or delete comments (🗑) with the buttons that are displayed to the right of the comment.

The screenshot shows the 'Business Analysts Community' interface. The top navigation bar includes the community name, type ('Community'), and actions ('Edit', 'Move', 'Delete'). A left sidebar contains navigation options: Overview, Organization, Comments (1), Responsibilities, Assets, History, and Files. The main content area is titled 'Organization' and displays a table of domains. The 'Comments' section at the bottom shows a comment by Christina Soucek asking to make @Anita Morison the Owner of the New Data Sets domain.

Name	Description	Owner	Stakeholders
Business Analysts Community			
Financial Services			
Schemas	Community containing all inge...		
Supply Chain Performance Management			
Tableau Server - Official Demo		Luke O' Reilly	
New Data Sets			

Comments

Write a comment...

Christina Soucek
@John Fisher, could you make @Anita Morison the Owner of the New Data Sets domain? a few seconds ago

Note Adding, editing and removing comments doesn't change assets, so their last modified date will not be updated.

Add comments

If you want to add a comment to a community, domain or asset, for example to discuss the description.

Note Adding, editing and removing comments doesn't change assets, so their last modified date will not be updated.

Steps

1. Open a community, domain or asset page.
2. Do one of the following:
 - In the tab pane, click  **Overview**.
 - In the tab pane, click **Details** → **Comments**.
3. Type your comment in the **Comments** field.
You can use the text editing tools to format your comment, to add links and images or to [mention](#) users.
4. Click **Save**.

User mentioning

User mentioning is a useful way to draw the user's attention to a page or comment. When you mention a user, they will receive an email which contains the content of the comment in which they are mentioned and a direct link to the asset page.

Mentioning users

To mention a user in a comment, you type the @ symbol followed by the user's first name, last name or username. Matching names appear as you start typing a name, even if the typed character is not the first character as shown in the following example.

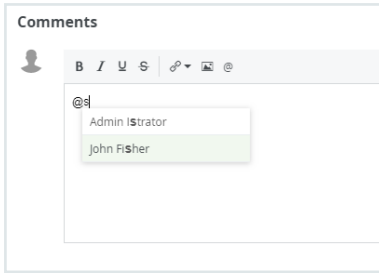

If the first name and or last name is available, these will be used to address the user, if those are not available, then the username will be used.

Note If a user is deleted, all the mentions are replaced by @Deleted User.

View permissions

If you mention a user who does not have the view permission on the asset, it will be indicated when you select the user.

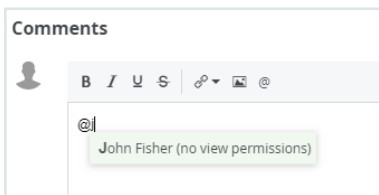

As a mentioned user, if you open the link in a mail, you see a Not authorized message if you don't have the permission to view the asset.

List of user mentions

To see all the comments in which you are mentioned, go to your own profile page and select **Mentions** in the tab pane.

You cannot see somebody else's list of mentions.

Item	Description
1	The name of the user who has mentioned you. This can be the full name, first or last name or the username of that user, depending on which information is available.
2	The name of the asset to which a comment is added.
3	The time when the comment has been added.
4	The direct link to go to the comment on the asset page. The comment will be highlighted on the asset page.

Email content

When you [add](#) a comment to an asset page, you can also mention users. Users who are mentioned, will receive an email.

You were mentioned

1 John Fisher mentioned you on the asset Customer Lifetime Value: 2

@Mike Jones please add a definition and descriptive example of this business term 3

Open See all mentions

4 5

Item	Description
1	The user who mentioned you in a comment, this can be the first name/last name or username. If you click the name, you go to the user's page in Collibra DGC.
2	The asset name to which a comment has been added in which you are mentioned. If you click the name, you go to the asset page in Collibra DGC.
3	The full content of the comment in which you are mentioned. If you click your name, you go to your own user page in Collibra DGC.
4	The button to open the comment in your Collibra DGC environment.
5	The button to open the list of comments in which you are mentioned. You have to sign in with your own account to see this list.

Attachments

An attachment is a file that you upload via an asset page, domain page or community page. You can use this to add reference materials or other documents that are related to the resource.

You can find attachments on the community, asset or domain page → **Files**.

File Name	Type	Uploaded by	Uploaded on
All data (1).xlsx	Excel Sheet (xlsx)	Admin Istrator	6/9/17

1 Attachment

Note

- Adding and removing attachments doesn't modify assets, so their last modified date will not be updated.
- Uploading attachments is restricted by the file upload settings, which determine the maximum file size, allowed file extensions and maximum amount of uploads and downloads per day. Contact [Collibra support](#) if you want to change the file upload settings.

Add attachments

You can add files to an asset, domain or community as [attachments](#).

Note

- Adding and removing attachments doesn't change assets, so their last modified date will not be updated.
- Uploading attachments is restricted by the file upload settings, which determine the maximum file size, allowed file extensions and maximum amount of uploads and downloads per day. Contact [Collibra support](#) if you want to change the file upload settings.

Steps

1. Open a community, domain or asset page.
 2. In the tab pane, click **Files**.
 3. Upload a file in one of the following ways:
 - Drag and drop the file in the upload area.
 - Click **Upload a file**, browse to the location of the file and click **Open**.
- » The file is displayed in the table.

Responsibilities

Responsibilities are used to assign a **resource role** to one or more **users** and/or **user groups**. Based on their responsibilities, users can act on the **permissions** conveyed to them via the resource role.

Responsibilities

A responsibility is the assignment of one or more **users** and/or **user groups** to a **resource role** for a resource.

Based on their responsibilities, users can act on the **permissions** conveyed to them via the resource role.

Child resources always inherit the responsibilities from their parent resources:

- If the resource is a community, the responsibilities are inherited by subcommunities, domains and assets in the community. For example, if you are a Business Steward for a certain community, you are a Business Steward for all the subcommunities, domains and assets inside that community.
- If the resource is a domain, the responsibilities are inherited by the assets in the domain.
- If the resource is an asset, the responsibilities only apply to the asset itself, because assets never have children.

Example

Suppose the following setup:

- Anita Morrison is assigned the Community Manager resource role for a community called "Enterprise".
- John Fisher is assigned the Business Steward resource role for a domain called "Critical Data Elements" in the "Enterprise" community.
- Joanna Zhou is assigned the Owner resource role for a domain called "Critical Data Elements" in the "Enterprise" community.
- William Parker is assigned the Owner resource role for an asset called "Customer Revenue" in the "Critical Data Elements" domain.

This leads to the following responsibilities:

Resource	Direct responsibilities	Inherited responsibilities
Enterprise community	<ul style="list-style-type: none"> • Anita Morrison as Community Manager 	<ul style="list-style-type: none"> • None
Critical Data Elements domain	<ul style="list-style-type: none"> • John Fisher as Business Steward • Joanna Zhou as Owner 	<ul style="list-style-type: none"> • Anita Morrison as Community Manager
Customer Revenue asset	<ul style="list-style-type: none"> • William Parker as Owner 	<ul style="list-style-type: none"> • Anita Morrison as Community Manager • John Fisher as Business Steward • Joanna Zhou as Owner

Note You can [view direct and inherited responsibilities](#) of a resource in different places.

View responsibilities for a resource

You can view the [responsibilities](#) for a resource in the following locations:

- In the **Responsibilities** tab of a resource.
- In any view that displays communities, domains or assets, in the specific column or field for that role.





- a. Open any view in table or tiles mode.
- b. Do one of the following:
 - In tile mode: [add](#) the required fields.
 - In table mode, [add](#) the required column.

Note

- Each role has its own field or column.
- Depending on the [settings](#) in Collibra Console, you may also see the inherited responsibilities.

- In the **Responsibilities** tab of a user's profile page.

Tip You can also view your own responsibilities.

- a. [Open](#) a profile page.
 - b. In the tab pane, click  **Responsibilities**.
 - » The [Responsibilities](#) page appears.
- In the **Responsibilities** tab of a user group page.
 - a. Open a group page.
 - i. In the main menu, click , then  **Settings**.
 - » The [Collibra DGC settings page](#) opens.
 - ii. Click **Users and groups**.
 - » The [users and groups settings](#) appear on the **Users** tab page.
 - iii. In the tab pane, click **Users** → **Groups**.
 - » The user group table appears.
 - b. In the tab pane, click  **Responsibilities**.
 - » The [Responsibilities](#) page appears.
 - In the **Preview** pane of an asset, for example on an asset page.

Note The preview pane only shows the direct responsibilities.

The Responsibilities page

The **Responsibilities** page shows the [view permissions](#) and the [responsibilities](#) of a resource.

The screenshot shows the 'SCPM Glossary' interface. At the top, there's a navigation bar with 'Business Analysts Community' and 'Supply Chain Performance Management'. The user is identified as 'Business Steward John Fisher'. The main content area is titled 'SCPM Glossary' and includes a search icon, 'Type: Glossary', and buttons for 'Edit', 'Move', 'Delete', and 'Auto hyperlinks'. A left sidebar contains navigation options: Overview, Assets, Responsibilities (selected), History, and Files. The main content area shows 'View permissions' (Unrestricted view permissions) and 'Responsibilities' (Add button). Under 'Responsibilities', there are three columns: 'Business Steward', 'Owner', and 'Stakeholder'. The 'Business Steward' column shows 'Inherited' with a gray box containing 'John Fisher'. The 'Owner' column shows a green box with 'Luke O' Reilly'. The 'Stakeholder' column shows a purple box with 'Aarav Singh Chopra'.

The background colors of the responsibilities show where the responsibility comes from.

Color	Description
Gray	The user or group inherited the role.
White	The user or group was directly assigned to this role for the resource.

If a user or group has a responsibility but not the required view permissions, a warning appears in the box. For example, a user was assigned the Steward role for a resource but does not have view permissions for it.

For information on view permissions, see the Collibra Data Governance Center Administration Guide.

Create a responsibility

You can create a responsibility:

- By assigning a resource role to a user or user group on the responsibilities page of a resource.
- By adding a user in the table column of a role.
- By [editing](#) an existing responsibility.

Important For optimal performance and ease of use, we recommend that you create responsibilities mainly on domains and communities and not directly on

assets. Creating responsibilities directly on large amounts of assets may lead to decreased performance.



Assign a resource role to a user or user group on the responsibilities page

1. Open a community, domain or asset page.
2. In the tab pane, click  **Responsibilities**.
 - » The **Responsibilities** page appears.
3. Above the table, to the right, click **Add**.
 - » The **Add responsibility** dialog box appears.
4. Enter the required information.

Option	Description
Role	Enter the role that you want to assign to a user or group for this resource.
People	Enter the users and user groups to which you want to assign a role for this resource.

5. Click **Add**.
 - » The users or groups with the assigned role are now displayed in the **Responsibilities** table.

Tip

- If you want to assign a user or user group a resource role that other users or groups already have for this resource, you can click  and add them in the **People** field in the **Assign role** box.
- If there are only inherited roles,  is not available.

Assign a role to a user or user group for a resource from a table

1. Open a table that displays communities, domains or assets.
2. If required, **add** the column of the role that you want to assign to the user.

3. Do one of the following:
 - Double-click a cell in the column of the role.
 - Hover your mouse pointer over a cell in the column and click .
4. Click in the field and enter the user or user group.
5. If required, select **Apply to visible rows**.

This will create the responsibilities for all visible users.

Tip You can [filter](#) the columns first, to assign a role to a user for specific resources in one go.

6. Click .

Edit a responsibility

You can edit a [responsibility](#):



- by [deleting](#) it and [creating](#) a new one.
- in an asset table.

Note You cannot edit inherited responsibilities.

Edit a responsibility in a table

1. Open a table that displays communities, domains or assets.
2. If required, [add](#) the column of the role that you want to edit.

Warning Depending on the [settings](#) in Collibra Console, you may also see the inherited responsibilities. You cannot edit these inherited responsibilities.

3. Do one of the following:
 - Double-click a cell in the column of the role.
 - Hover your mouse over a cell in the column and click .
4. Edit the responsibility:
 - Click in the field and enter a new user or user group.
 - Click  next to the user or user group to remove the user or user group.
 - If required, select **Apply to visible rows**.
This will edit the responsibilities of all visible users.

Tip You can **filter** the columns first to assign a user to specific resources in one go.

5. Click ✓.

Delete a responsibility

You can delete a **responsibility**:

- From the **responsibilities page** of a resource.
- From a table.

Note You cannot delete inherited assignments.

Delete a responsibility from the responsibilities page of a resource

1. Open a community, domain or asset page.
2. In the tab pane, click **Responsibilities**.
 - » The **Responsibilities** page appears.
3. In the **Responsibilities** table, click **✕** next to the name of the user or group that you want to remove.

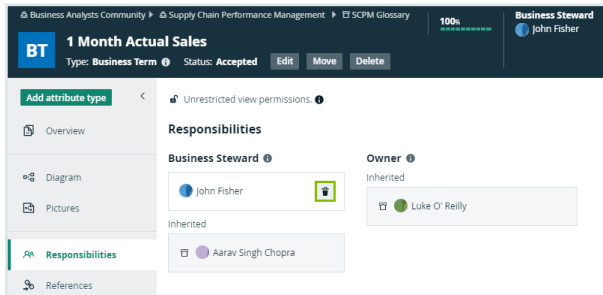



4. Click **Delete** to confirm.

Delete responsibilities for a resource from a table

1. Open a table that displays communities, domains or assets.
2. If required, [add](#) the column of the role that you want to edit.

Warning Depending on the [settings](#) in Collibra Console, you may also see the inherited responsibilities. You cannot delete these inherited responsibilities.

3. Do one of the following:
 - Double-click a cell in the column of the role.
 - Hover your mouse over a cell in the column and click .
4. In the cell editor, click  next to the user or user group.
5. If required, select **Apply to visible rows**.

This will delete the responsibilities from all visible users.

Tip You can [filter](#) the columns first to assign a user to specific resources in one go.

6. Click .

View permissions

A view permission is the right to see a resource and its children. It determines which users can see and work with which resources. You assign a view permission to [users](#) or [user groups](#) on [domain](#) or [community](#) level. Consequently, only these users can see the resources and their children, including the assets. This also includes relations to assets: if you do not have view permissions for an asset, you don't see the relations to that asset, for example in [views](#) or on the [asset page](#) of the related assets.

Understanding view permissions

By default, all users can see all resources. You can tell that there are no view permissions if **Unrestricted view permissions** is in the View permissions section of the resource's [Responsibilities](#) page.

The screenshot displays the SAP Business Analysts Community interface for the 'SCPM Glossary' resource. The top navigation bar shows 'Business Analysts Community' and 'Supply Chain Performance Management'. The user is identified as 'Business Steward John Fisher' with 'admins' as a group. The main content area is titled 'View permissions' and shows 'Unrestricted view permissions' with an 'Add' button. Below this is the 'Responsibilities' section, which is divided into 'Business Steward' (listing John Fisher) and 'Owner' (listing Luke O' Reilly). An 'Inherited' section shows 'admins'.

If you add users or user groups to the view permissions of a resource, only those users or groups can view the resource and its children.

All child resources inherit the view permissions from parent resources. Once you have added users or user groups to the view permissions of a resource, you cannot create view permissions for any of its child or parent resources.

You can recognize inherited view permissions by their gray background.

Note

- A user with the System Administration global permission, for example via the Sysadmin global role can see all views in Collibra DGC, even if they are not shared.
- A user with the Manage all views permission can see only views that are shared.

Impact of view permissions on responsibilities

View permissions affect **responsibilities**. If a user has a responsibility for a certain resource, but does not have view permission, that user cannot act upon that responsibility. The responsibility becomes inactive, due to the lacking view permission.

To activate the responsibility, you have to **create** the view permission for this resource or a parent resource.

Example

In the example below, Luke O'Reilly is the Owner of the SCPM Glossary domain, but he does not have the view permission to see the domain. As a consequence, he cannot see the assets or act on his responsibility. On the Responsibilities page, his responsibility shows an error message to clearly show that there is a problem. You can solve the problem in one of the following ways:

- [Create](#) a view permission for Luke.
- [Add](#) Luke to the user group that has a view permission.
- [Delete](#) all view permissions, so that everyone can see the assets.
- [Delete](#) Luke's responsibility as Owner and pick another person for that role.

The screenshot shows the 'SCPM Glossary' interface. At the top, it indicates the user is 'Business Steward' John Fisher. The main content area is divided into two sections: 'View permissions' and 'Responsibilities'.

View permissions: Shows a list of permissions. The 'Data Custodians' group is listed with a lock icon and the text 'Restricted view permissions.' Below this, a user 'John Fisher' is listed with a blue profile icon.

Responsibilities: Shows the current user's responsibilities. Under 'Business Steward', 'John Fisher' is listed. Under 'Owner', 'Luke O' Reilly' is listed with a red profile icon and a red error message: 'No view permission'. Below these, an 'Inherited' section shows the 'admins' group with a red error message: 'No view permission'.

Create a view permission

You can create a [view permission](#) if you don't want all users to see certain resources.

Prerequisites

- You have a [resource role](#) with the Edit View Permissions [resource permission](#), for example Community Manager.

- None of the parent communities or children of the current resource have a view permission.

Steps

1. Open a community or domain page.
2. In the tab pane, click  **Responsibilities**.
 - » The [Responsibilities](#) page appears.
3. Above the table, to the right, click **Add**.
 - » The **Add view permissions** dialog box appears.
4. In the **Users or Groups** field, start typing the name of the user or user group.
5. Select a user or user group from the suggestions.
6. Click **Add**.



Delete a view permission

You can delete a [view permission](#) if you want to change which users are allowed to see certain resources.

Prerequisites

- You have a [resource role](#) with the Edit View Permissions [resource permission](#), for example Community Manager.
- One or more users or user groups have a view permission on the resource.

Steps

1. Open a community or domain page.
2. In the tab pane, click  **Responsibilities**.
 - » The [Responsibilities](#) page appears.
3. In the View Permissions section, click  next to the name of the user or group that you want to remove.

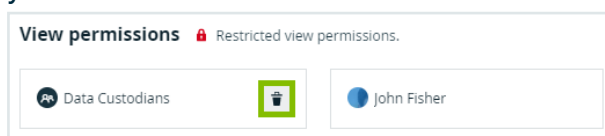

- » A confirmation message appears.

4. Click **Delete**.

- » One view permission is deleted, so only the remaining users or user groups can see this resource and its children.
- » If you deleted the last view permission, all users can now see this resource and its children.

Asset data quality

The **Quality** page of an asset makes data quality results of an asset available to the business stakeholders. The dashboard aggregates the following values:

- Collected over time on attributes.
- Aggregated from different assets along a number of predefined relations.

The assets for which these data quality dashboards are available and how the values are aggregated are defined in [data quality rules](#), which can be edited on the **Data Quality Rule** tab on the ⚙️ **Settings** page. For the following examples, a data quality rule exists on business terms, aggregating values from data quality rules related to these business terms.

Asset quality

The assets for which the quality dashboard is available have an extra option in their tab menu, namely **Quality**. The dashboard displays the aggregated passing fraction (quality score) for the asset in the form of ring charts.

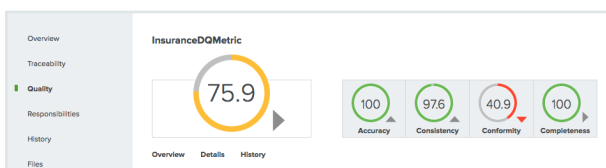

Each ring chart shows the quality score in the form of:

- A quality score as a percentage.
- A color code indicating the quality of this passing fraction:
 - Red: 0-50%
 - Orange: 50-85%
 - Green: 85 - 100%

- An arrow indicating the trend of the score compared to the previous measurement.

The first ring chart shows the general score of the asset. The ring charts next to it show subscores for a specific dimension, such as **Accuracy**, **Conformity**, **Completeness** and **Consistency**. Only values that belong to that specific dimension are then taken into account. The dimensions to use are configured in the metric group. In this example, it is the relation: **Data Quality Rule** is Classified By **Data Quality Dimension**.

Underneath the top pane, three selection boxes are available. They display an extra overview, details and history pane, respectively.

To close a pane, click ✕ in the upper-right corner of the pane.

Data quality overview pane

The **Overview** pane shows more information about each level in the aggregation path for the selected general score or dimension. For each level, it shows the number of involved assets of a certain type and what their results are: failing (red) or passing (gray). It also shows the total number of rows, the number of failing rows (red) and the number of passing rows (gray) that resulted in the given scores.

In the following example, the **Conformity** dimension consists of a total of 38 070 rows, 26 575 of which were failing. Two **Data Quality Rules** were involved, one of which was failing. And these **Data Quality Rules** were used by one **Data Entity**, which has an aggregated failing result.

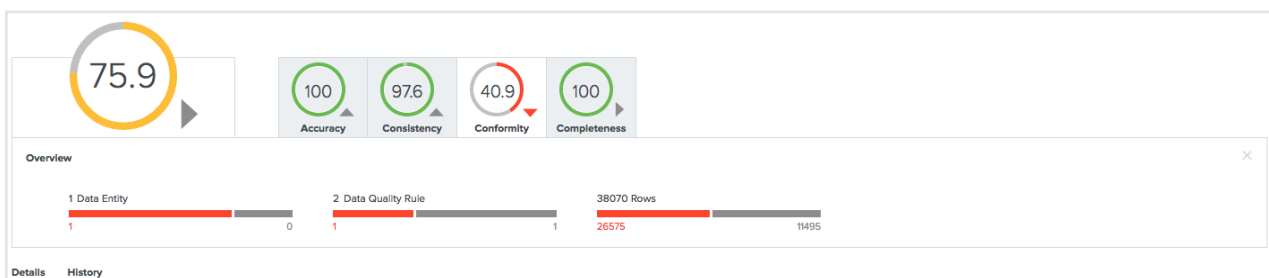

Asset quality details pane

The **Details** pane shows more information about all the assets involved in a table format.

For each asset, a row with the following default columns is shown:

- **Data Asset:** The data asset signifier
- **Rows Passed:** The number of passing rows, aggregated as a sum of the passing rows of the underlying assets
- **Rows Failed:** The number of failing rows, aggregated as a sum of the failing rows of the underlying assets
- **Quality Score:** The score aggregated as an average of the quality scores of the underlying assets
- **Result (failing or passing):** The aggregated result as a logical conjunction of the results of the underlying assets.

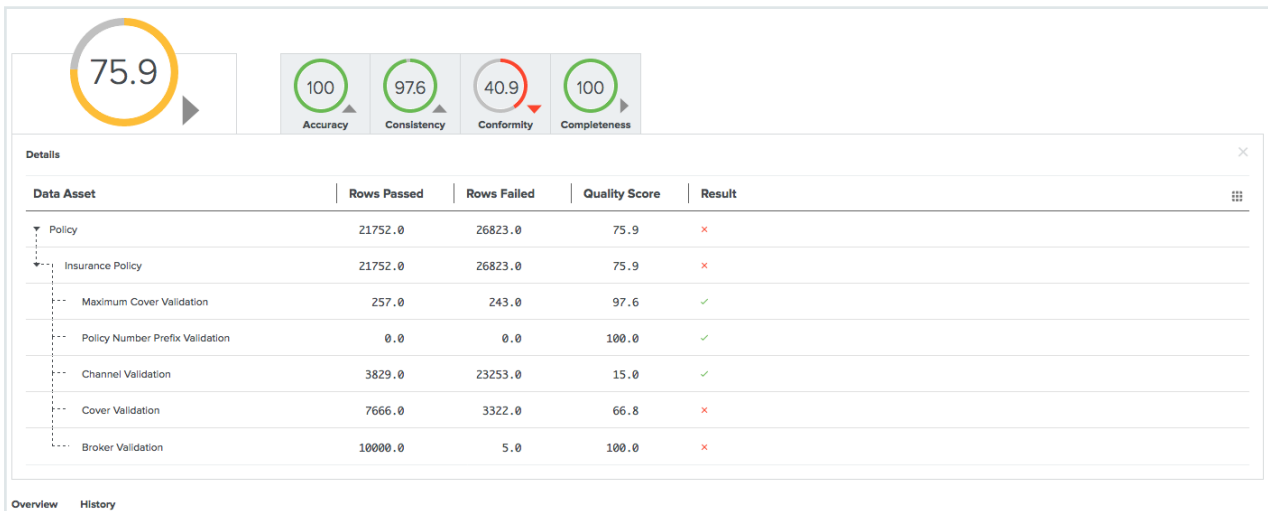

Some extra columns can be displayed in this table by clicking → **Columns**.

These include:

- **Full name:** The unique full name of the asset.
- **Domain:** The domain to which the asset belongs.
- **Type:** The type of the asset.
- **Dimension:** The dimension that applies to these assets, if any. Dimensions are used to calculate the subscores, as mentioned earlier.

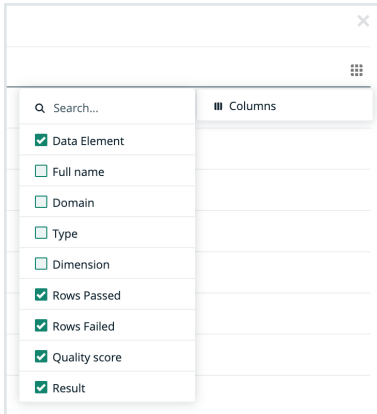

Asset quality history

The **History** pane shows the evolution of the quality score over time, for up to one month in the past.

You can display the date and the score for a specific period at the top right of the pane by hovering your pointer over that period.

When you select a period by clicking on it, the top left corner of the pane shows a trend of the score compared to the period before it.



Validation rules

Validation rules are special assets of the type **Validation Rule**. They allow you to verify whether assets meet certain criteria. They have a special attribute **Validation Script**, which contains a [validation script](#) that evaluates assets of the types to which the validation rule is assigned.

Administrator actions

- Create a domain of the type **Validation rule domain**.
- [Create a validation rule](#).
- [Edit a validation rule](#).
- [Delete a validation rule](#).
- [Assign a validation rule to an asset type](#).
- [Change the order of validation rules](#).
- [Unassign a validation rule from an asset type](#).

User actions

- [Validate assets](#).
- [View the validation result](#).
- [Revalidate an asset](#).

Executing validation rules

You can execute validation rules in many ways:

- [Validate assets](#)
Do this to manually validate assets.
- [Revalidate an asset](#)
Do this after editing an invalid asset.
- [Automatically](#).
You can configure a workflow to start a validation on given events. For example when a asset is added or an attribute is edited.
To configure triggers on certain events, see [Getting started with workflows](#).

Validation logging

Collibra Data Governance Center can write extensive log messages from the execution of validation rules. These messages are written to the **dgc.log** file.

If the execution of a validation rule fails, analyzing the log is probably the most thorough approach.

For more information on how to configure validation logging, see [Logging](#).

Tip When contacting support regarding a problem with validation, attach the log file to the ticket.

Validate assets

Validating an asset executes all validation rules assigned to the asset type. If an asset does not meet all validation rules, the asset is invalid.

You can see the validation result on:

- An asset page's title bar.
- As a column, when viewing assets in table [display mode](#).
- As a field, when viewing assets in tiles display mode.
- As an overlay in a traceability diagram.

After validation, the **dgc.log** file will also contain more extensive messages. For more information on how to configure validation logging, see [Logging](#).

Note By default, validation is not automatically triggered when an asset is edited, so you have to revalidate it after editing an asset. However, you can create a workflow for this. To configure validation on certain events, see [Getting started with workflows](#).

Prerequisites

- Either of the following:
 - You have a [resource role](#) with the Validation Execution [resource permission](#), for example Community Manager.
 - You have a [global role](#) that has the Manage all resources [global permission](#).

Validate an asset from the asset page

1. Open an asset page.
2. In the resource toolbar, click **(validate)**.

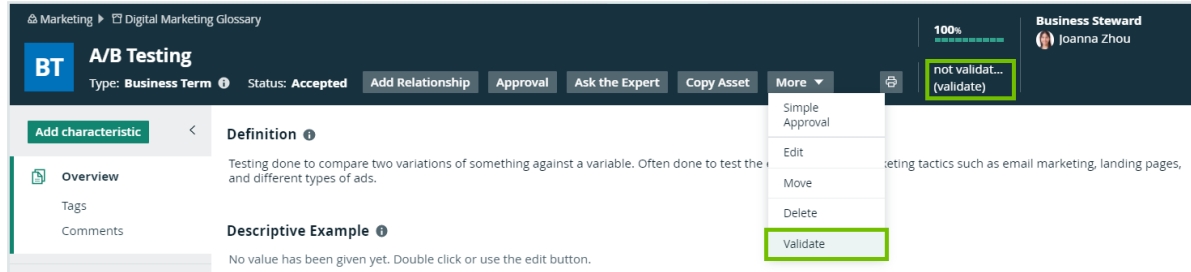

Validate one or more assets from an asset table

1. Open a set of assets in table display mode.
2. Select checkboxes in front of the assets you want to validate.
3. In the action toolbar, click **Validate**.

Validate one or more assets from a set of tiles

1. Open a set of assets in tile display mode.
2. Select the assets you want to validate.
3. In the action toolbar, click **Validate**.

Revalidate an asset

You can revalidate assets that were previously validated to see whether they meet the [validation rules](#) that are assigned to the asset type.

Validating an asset executes all validation rules that are assigned to the asset types. If an asset does not meet all validation rules, the asset is invalid.

You can see the validation result:

- An asset page's title bar.
- As a column, when viewing assets in table [display mode](#).
- As a field, when viewing assets in tiles display mode.
- As an overlay in a diagram.

Note You can create a workflow to automatically revalidate assets. To configure validation on certain events, see [Getting started with workflows](#).

Prerequisites

- Either of the following:
 - You have a [resource role](#) with the Validation Execution [resource permission](#), for example Community Manager.
 - You have a [global role](#) that has the Manage all resources [global permission](#).

Revalidate an asset from the asset page

1. Open an asset.
2. In the upper right corner, click **valid** or **invalid**.
3. Click **Revalidate**.

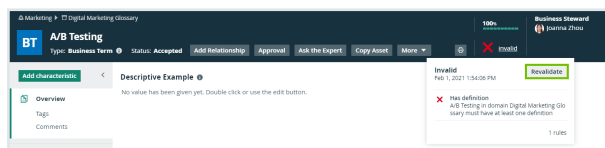

Revalidate one or more assets from an asset view

1. Open an asset table.
2. Select checkboxes in front of one or more assets.
3. In the action toolbar, click **Validate**.

Revalidate an asset from an asset view

1. Open an asset table.
 2. If you don't see the **Validation Result** column, add it to the table.
More info on adding columns to a table: [Customizing tables](#).
 3. Click or .
- You can see the validation result of each validation rule.

4. Click **Revalidate**.

<input type="checkbox"/> Name ↑	Definition	Validation Result
<input type="checkbox"/> A/B Testing	Testing done to compare two variations of something ag...	✘
<input type="checkbox"/> AdWords	Google's advertising system in which	Invalid Feb 1, 2021 1:57:25 PM Revalidate
<input type="checkbox"/> Affiliate Marketing	When a publisher (website with a lo	
<input type="checkbox"/> API	Application Programming Interfaces	✘ Has definition A/B Testing in domain Digital Marketing Glo ssary must have at least one definition
<input type="checkbox"/> Attribution	Identifying which part of a marketin	
<input type="checkbox"/> Audience	The group of specific people a brand	1 rules

View the validation result

After validating or revalidating assets, you can view the result and make changes where necessary.

View the validation result from the activities list

1. Open the activities list.
 - » In the table, you see the validations.
2. In the results column, click **Result**.
 - » The **Validation results** dialog box appears.

Example

Validation results					
Rules executed					
Result	Asset	Rule	Message	Domain	
✓	Country	KDW VR1		New Business Terms	
✓	Currency Conversion	KDW VR1		New Business Terms	
✓	Customer	KDW VR1		New Business Terms	
✓	Customer Revenue	KDW VR1		New Business Terms	
✓	DDD	KDW VR1		New Business Terms	
✗	DW	KDW VR1	Name should have more than ...	New Business Terms	
✓	DWK	KDW VR1		New Business Terms	
✗	K	KDW VR1	Name should have more than ...	New Business Terms	
✓	KDW	KDW VR1		New Business Terms	
✓	Order	KDW VR1		New Business Terms	
✓	Order Date	KDW VR1		New Business Terms	
✗	W	KDW VR1	Name should have more than ...	New Business Terms	

- The results column shows ✓ or ✗ to indicate whether they are respectively valid or invalid.

Tip If you want to fix invalid assets, you can open them by clicking them.

View the validation result on the asset page

- Open an asset page.
- In the upper right corner, you see ✓ **valid** or ✗ **invalid**.

View the validation result in an asset table

- Open an asset table.
- If you don't see the **Validation Result** column, add it to the table.
More info on adding columns to a table: [Customizing tables](#).
- Click ✓ or ✗.
 - » You can see the validation result of each validation rule.

History in Collibra DGC

Collibra Data Governance Center automatically keeps a history of users and resources such as assets, domain and communities. This history keeps track of most changes to that resource and its children, as well as who made the changes.

Example

Users can provide a definition of a business term, edit its name, move it to a new domain, and change the status. These changes are in the history of the affected assets, their parent domain, all parent communities and the history of the users themselves.

You can view the history of any resource in the **History** tab of the resource's page, as shown in the following image.

The screenshot shows the 'customer revenue' page in the Collibra DGC. The page header includes the breadcrumb 'Data Governance Council > New Business Terms', the business term name 'customer revenue' with a rating of 4 stars, and the status 'Candidate'. A 'Business Steward' John Fisher is also indicated. The main content area displays a history table with columns for Action, Who, and timestamps. The history includes various actions such as 'Attachment', 'Update', 'Simple Approval Process Ended', 'Status Candidate Accepted', 'Simple Approval Process Started', 'tag SaaS', 'Definition', 'Comment', 'tag SaaS', 'Rating', 'represents', 'Business Steward', and 'Definition'.

Action	Who	from	to
+ Attachment customer revenue report calculation.xlsx	John Fisher	1/11/2019	2/11/2019 2:01 PM
▼ Update 2 changes	John Fisher		2/11/2019
Simple Approval Process Ended	John Fisher		2/11/2019 2:00 PM
Status Candidate Accepted	John Fisher		2/11/2019 2:00 PM
Simple Approval Process Started	John Fisher		2/11/2019 2:00 PM
tag SaaS	John Fisher		2/11/2019 1:59 PM
Definition Customer Revenue is the revenue associated with the customer-or-customer-contract.	John Fisher		2/11/2019 1:59 PM
+ Comment Don't confuse with customer lifetime value!	John Fisher		2/11/2019 1:58 PM
+ tag SaaS	John Fisher		2/11/2019 1:58 PM
+ Rating ★★★★☆ customer revenue	John Fisher		2/11/2019 1:58 PM
+ represents represents 35168	John Fisher		2/11/2019 1:58 PM
+ Business Steward John Fisher	John Fisher		2/11/2019 1:57 PM
+ Definition Customer Revenue is the revenue associated with the customer or customer contract.	John Fisher		2/11/2019 1:54 PM
+ customer revenue	John Fisher		2/11/2019 1:54 PM

History page

The History page provides an overview of the history of a user or a resource and its children. For examples, it contains all actions related to the following:

- Creating, editing and deleting resources.

Note

In some cases, an edit is logged as a delete plus a create. For example, if you edit a Description attribute of a Data Usage complex relation, the original Description attribute is deleted, and a new Description attribute is created with the new content.

- Moving assets to a different domain.
- Adding, editing and removing characteristics.
- Changes to the asset status.
- Social features such as comments, tags and ratings.
- Uploading and deleting attachments.
- Workflows and the resulting changes.
- Creating, editing and deleting responsibilities.

Note

- The history does not show changes to inherited responsibilities.
- The history does not show changes to the view permissions.

- In the case of the user history, adding and removing the user to or from user groups.

Tip Some actions do not change the last modification date of an asset. [See here](#) for actions that do change the last modification date and actions that don't.

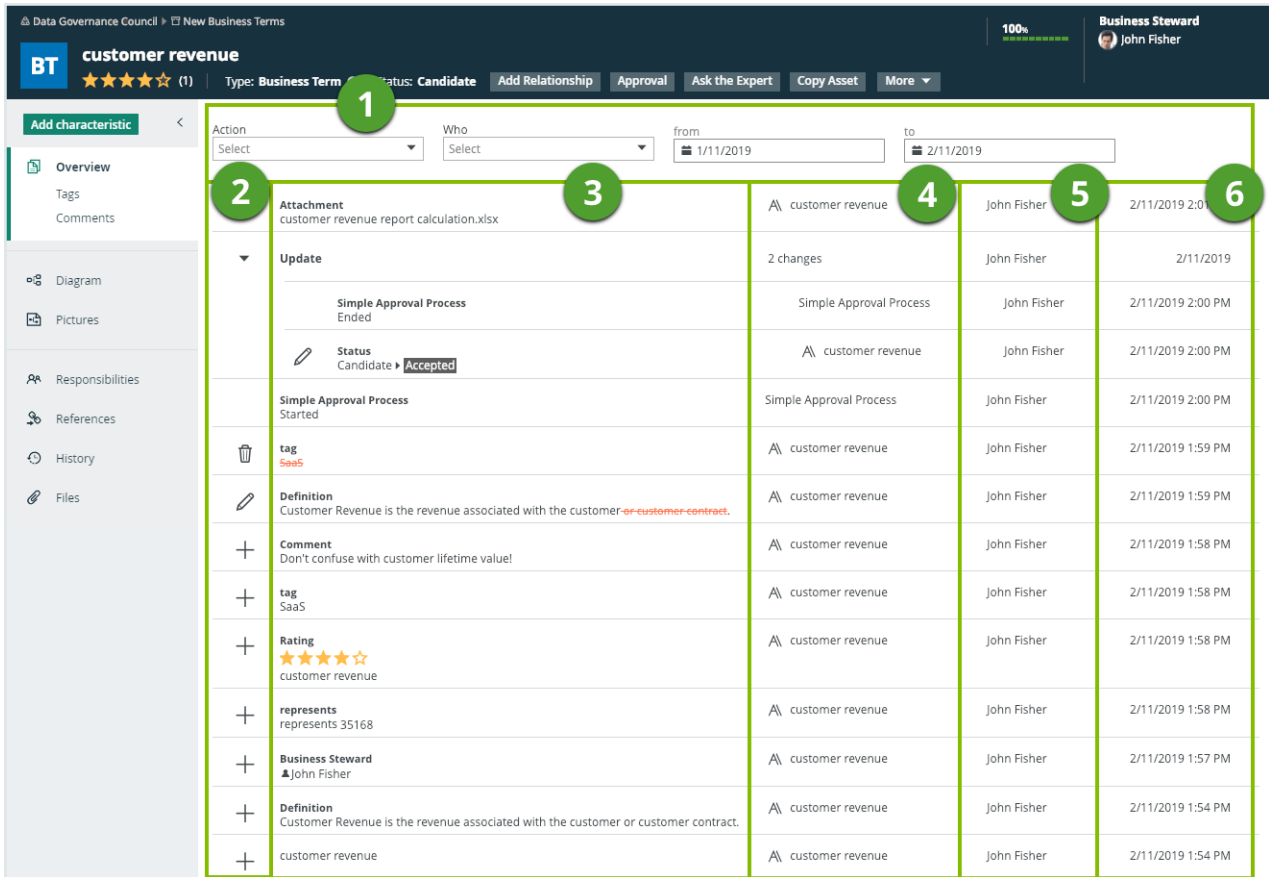

Column	Content
1	The filter that allows you to filter the history based on the type of action, the user or a time period.
2	The icon that represents the type of action that was applied to the resource: <ul style="list-style-type: none"> • + : Added information. • ✎ : Edited information. • 🗑️ : Deleted information. • ▶ : Multiple changes in one go. Click the icon to expand and show the individual changes
3	The summary of the action.
4	The name of the affected resource.

Column	Content
5	The user who applied the action.
6	The date and time when the action was applied.

View the history of a resource

You can view the change history of an asset, domain or community.

Steps

1. Open an asset page.
2. In the tab pane, click  **History**.
 - » The history is shown in a table.

Note By default, the filter only shows the 10 latest changes in the last month.

3. If required, do one of the following:
- Click **Load More** below the table to load more history items.
 - Edit the filter criteria above the table to see only specific history items.

Criterion	Description
Action	<p>Choose one of the actions:</p> <ul style="list-style-type: none"> ▪ Add ▪ Edit ▪ Delete <p>The effect of this filter criterion depends on the resource:</p> <ul style="list-style-type: none"> ▪ For assets, this includes action that affect an attribute. ▪ For domains, this includes actions affecting the domain itself, but also actions affecting assets in the domain. ▪ For communities, this includes actions affecting the community itself, but also actions affecting assets, domains and subcommunities of the community.
Who	Choose a user whose actions you want to see.
from	<p>Choose the start date of the period of which you want to see the actions.</p> <p>The default value of this criterion is one month before the current date.</p>
to	<p>Choose the end date of the period of which you want to see the actions.</p> <p>The default value of this criterion is the current date.</p>

- Remove one or more filter criteria by deleting the value in the filter box using the `Delete` key of your keyboard.

About the last modification date

The last modification date shows the date of the last modification to an asset. Not all modifications to an asset will change this date. On this page, you see an overview of actions that change the last modification date and actions that don't.

Actions that change the last modification date

- Asset property changes:
 - Asset (full) name
 - Asset display name
 - Asset status
 - Move asset to another domain
 - Exclude or include asset from auto-hyperlinking
- Asset attribute changes:
 - Add new attribute
 - Edit attribute value
 - Delete an attribute
- Other:
 - Validation result
 - Articulation score

Actions that don't change the last modification date

- Asset relations:
 - Add a relation to an asset
 - Remove a relation from an asset
- Asset responsibilities:
 - Grant a new role to a user or user group
 - Remove a user or user group
- Collaborative actions:
 - Add or remove tags
 - Add or remove ratings
 - Start workflows
 - Task completion
 - Add, edit or remove comments

- Other:
 - Add attachment
 - Take diagram picture

Importing and exporting

The import and export functionality in Collibra Data Governance Center are useful to respectively quickly add or update content and to transfer data to an external file or system.

Importing

The [import functionality](#) allows you to create or edit data in bulk in Collibra Data Governance Center.

When you import, you create or edit assets or complex relations and their characteristics such as attributes, relations and tags from a view.

Tip For easier bulk changes, you can perform the so-called export/import roundtrip. First [create](#) a view that contains all the characteristics, then [export](#) that view, edit the exported file, and [import](#) it back into the same view. Collibra DGC will automatically map the characteristics during the import.

For example, you can use the import functionality to do the following:

- Create assets in an existing domain.
- Create assets in a new domain.
- Add and edit characteristics of existing assets.
- Edit the display name of existing assets.
- Edit the full name of existing assets.
- Move assets to an existing domain.
- Move assets to a new domain.

Tip The import functionality is also suited for integrations and synchronization with external systems. The Import REST API is more appropriate for that purpose. Visit the [Developer Portal](#) to learn more.

Note Exporting and importing assets and complex relations is restricted by the file upload settings, which determine the maximum file size, allowed file extensions and maximum amount of uploads and downloads per day. Contact [Collibra support](#) if you want to change the file upload settings.

Import assets

You can import assets with the [import functionality](#). For example, this is useful if you have a list of business terms in Excel and you want to manage them in Collibra Data Governance Center.

Tip For easier bulk changes, you can perform the so-called export/import roundtrip. First [create](#) a view that contains all the characteristics, then [export](#) that view, edit the exported file, and [import](#) it back into the same view. Collibra DGC will automatically map the characteristics during the import.

Note Exporting and importing assets and complex relations is restricted by the file upload settings, which determine the maximum file size, allowed file extensions and maximum amount of uploads and downloads per day. Contact [Collibra support](#) if you want to change the file upload settings.

Prerequisites

You have prepared an Excel or CSV file for upload:

- Only the essential sheets, columns and rows remain.
- Numbers that have to be interpreted as text are preceded by a single quotation mark.
- Dates are formatted as yyyy-mm-dd.

Note Importing data from a large Excel file can consume a lot of memory. We advise you to import from CSV instead of Excel, or to limit the Excel file to only contain the data you really need.

Steps

1. Open a view.
2. Above the table, to the right, click  → **Assets**.
 - » The **Import** dialog box appears.
3. Click **Select File** and choose the appropriate Excel or CSV file for upload.
4. Click **Next**.
5. If you chose a CSV File, do the following:
 - a. Enter the required information.

Field	Description
Column Separator	The character used to delimit the columns in the CSV file.
Quote	The character before and after a string to capture the entire cell.
Escape Character	The character that is used to use the column separator or quote character as plain text.

- b. Click **Next**.
6. Manage the mapping of the columns of the import file and the view's fields.
 - a. The **Import mapping** dialog box appears and Collibra DGC tries to map the fields of the view automatically to the columns in the import file, based on the names of the fields and columns.

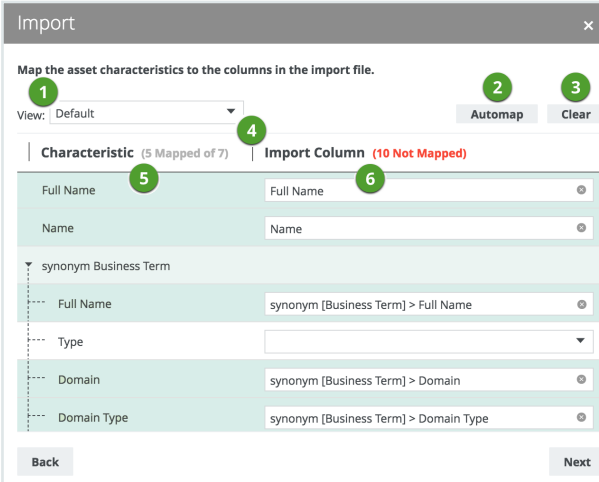

The screenshot shows the 'Import' dialog box with the following elements:

- 1**: View dropdown menu (currently set to 'Default').
- 2**: Automap button.
- 3**: Clear button.
- 4**: Tabbed interface with 'Characteristic (5 Mapped of 7)' and 'Import Column (10 Not Mapped)' tabs.
- 5**: Mapping for 'Full Name' characteristic to 'Full Name' import column.
- 6**: Mapping for 'Name' characteristic to 'Name' import column.
- Expanded 'synonym Business Term' section with mappings for 'Full Name', 'Domain', and 'Domain Type'.
- Buttons for 'Back' and 'Next' at the bottom.

Number	Field	Description
1	View selector	<p>The view selector allows you to choose a view whose characteristics will appear in the list.</p> <div style="background-color: #f0f0f0; padding: 10px; border-left: 2px solid #008000;"> <p>Tip You can also choose All characteristics to show all characteristics.</p> </div>
2	Automap	<p>Button to let Collibra DGC automatically map all fields of the view to the columns in the import file, based on the names of the characteristics and columns.</p>
3	Clear	<p>Button to clear all mapped characteristics in the Import Column.</p>
4	Mapping table	<p>This table enables you to map characteristics of the view to columns of the import file.</p> <p>Each row has a background color to indicate whether a characteristics is mapped or not.</p> <ul style="list-style-type: none"> ▪ Dark green: The characteristic is mapped to a column in the import file. ▪ Light green: The relation is mapped partially. This means not all underlying fields are mapped. ▪ White: The characteristic is not mapped.

Number	Field	Description
5	Characteristic	This column contains the available characteristics. Depending on the selection in the view selector, it contains either the characteristics of the selected view, or all characteristics. For relations, a hierarchy is displayed.
6	Import Column	This column should contain fields in which you can choose columns of the import file to map to a characteristic of the view.

- b. If required, choose another view in the view selector.

Tip Choose **All characteristics** to show all characteristics. In most cases, this makes it easier to map all characteristics.

- c. Click **Automap** to let Collibra DGC map all visible columns automatically.
d. If required, manually map columns to another characteristic.
7. Click **Next**.
- » The **Import options** appear.

8. Enter the required information.

Setting	Result
Create new assets and domains if non-existent.	<p>If assets or domains do not exist, Collibra DGC creates them.</p> <p>Collibra DGC creates a new domain and top-level community if the following conditions are met:</p> <ul style="list-style-type: none"> ○ You mapped columns of the import file to the domain, domain type and community characteristics of the view. ○ The columns contain a domain and/or community name that doesn't exist yet.
How do you want to handle existing assets?	
<p>Replace them with the new assets. (=> delete + create)</p>	<p>If assets exist, Collibra DGC deletes them first and creates them again based on the import file.</p>
<p>Update the name, properties and attributes.</p>	<p>If assets exist, Collibra DGC compares the attributes and updates them if necessary.</p>
How do you want to handle mapped attributes?	
<p>Replace them with new attributes. (=> delete + create)</p>	<p>If attributes exist, Collibra DGC deletes them and creates them again based on the import file.</p> <p>Select this option if you want to update existing, or add new attributes, such as a definition.</p>

Setting	Result
Create as new attributes.	<p>If attributes exist, Collibra DGC creates another instance of the attributes based on the import file.</p> <p>Select this option if you do not want to edit the existing attributes, but always want to create new attributes. This could result in multiple instances of the same attributes, such as a definition.</p>
Delete existing assets from the domain that are not in the file.	Collibra DGC deletes the assets that are not in the import file.
Test Import	Collibra DGC first simulates an import without affecting the data to give you an overview of how the actual import would affect the data. After the overview, you can proceed with the import, go back to change the options or cancel the import.

9. Click the **Test Import** button.
 - » The test results appear.
10. If everything looks okay, click **Import**.
 - If it doesn't, close the dialog box to cancel the import or click **Back** to change the mapping or import options.
 - » The import results appear.
11. Click **Close**.

Import complex relations

You can import [complex relations](#) with the [import functionality](#). For example, this is useful if you want to create a lot of complex relations in one go.

Tip For easier bulk changes, you can perform the so-called export/import roundtrip. First [create](#) a view that contains all the characteristics, then [export](#) that view, edit the exported file, and [import](#) it back into the same view. Collibra DGC will automatically map the characteristics during the import.

Tip For importing complex relations using an Excel file, see the knowledge base on the [Collibra Support Portal](#).

Note Exporting and importing assets and complex relations is restricted by the file upload settings, which determine the maximum file size, allowed file extensions and maximum amount of uploads and downloads per day. Contact [Collibra support](#) if you want to change the file upload settings.

Prerequisites

You have prepared an Excel file for upload:

- Only the essential sheets, columns and rows remain.
- Numbers that have to be interpreted as text are preceded by a single quotation mark.
- Dates are formatted as yyyy-mm-dd.
- The related assets to connect for a single complex relation must be specified in a single cell.
- Your import file has the correct [structure](#) to import complex relations.

Steps

1. Open a view.
2. Above the table, to the right, click  → **Complex Relations**.
 - » The **Import** dialog box appears.
3. Click **Select File** and choose the appropriate Excel file for upload.
4. Click **Next**.
5. Select the complex relation type that you want to import.
6. Click **Next**.
7. Manage the mapping of the columns of the import file and the view's fields.
 - a. The **Import mapping** dialog box appears and Collibra DGC tries to map the fields of the view automatically to the columns in the import file, based on the names of the fields and columns.

Number	Field	Description
1	Automap	Button to let Collibra DGC automatically map all fields of the view to the columns in the import file, based on the names of the characteristics and columns.
2	Clear	Button to clear all mapped characteristics in the Import Column .

Number	Field	Description
3	Mapping table	<p>This table enables you to map characteristics of the view to columns of the import file.</p> <p>Each row has a background color to indicate whether a characteristics is mapped or not.</p> <ul style="list-style-type: none"> ▪ Dark green: The characteristic is mapped to a column in the import file. ▪ Light green: The relation is mapped partially. This means not all underlying fields are mapped. ▪ White: The characteristic is not mapped.
4	Characteristic	<p>This column contains the available characteristics. Depending on the selection in the view selector, it contains either the characteristics of the selected view, or all characteristics. For relations, a hierarchy is displayed.</p>
5	Import Column	<p>This column should contain fields in which you can choose columns of the import file to map to a characteristic of the view.</p>

- b. If required, choose another view in the view selector.

Tip Choose **All characteristics** to show all characteristics. In most cases, this makes it easier to map all characteristics.

- c. Click **Automap** to let Collibra DGC map all visible columns automatically.
d. If required, manually map columns to another characteristic.

8. Click **Next**.
 - » The **Import options** appear.
9. Enter the required information.

Setting	Result
Test Import	Collibra DGC first simulates an import without affecting the data to give you an overview of how the actual import would affect the data. After the overview, you can proceed with the import, go back to change the options or cancel the import.

10. Click the **Test Import** button.
 - » The test results appear.
11. If everything looks okay, click **Import**.
 - If it doesn't, close the dialog box to cancel the import or click **Back** to change the mapping or import options.
 - » The import results appear.
12. Click **Close**.

Import file structure of a complex relation

You can define multiple relations with the same role.

The different assets to relate to are formatted as a comma-separated list in a single cell.

This means that:

- For every role in the complex relation type, you have to specify the **Asset** column. Fill in a comma-separated list of the asset names to connect to the complex relation with that role. If there is an asset in the import file that does not exist, it is created automatically.
- If an asset name contains a comma, you can use double quotes around the asset names to ignore the comma as a separator.
For example, to refer to an asset named **last name, first name**, the name has to be written as "**last name, first name**".
- If your asset names have commas as well as double quotes, you can change the standard behavior of the double quote by using a backslash (\).

For example, to refer to an asset called **last name** "," **first name**, the name has to be written as "**last name \",\" first name**".

- If you specify the domain names for mapped assets, you also have to use a comma-separated list in the **Domain** column, even if the domain is the same for all the assets.
- If you have to specify the domain and community for the relation assets as well, it is important that the size and order of the comma-separated lists for all three aspects (asset name, domain, community) is the same.
- If the referred assets are not all in the current domain, you can specify one or more domains to search in, by mapping the **Domain** characteristic to a column containing a comma-separated list of domain names. If there is a domain in the import file that does not exist, it is created automatically.
- If the referred domains are not all in the current community, you can specify one or more communities to search in, by mapping the **Community** characteristic to a column containing a comma-separated list of community names.

Exporting

The export functionality makes it easy to transfer data from Collibra DGC to an external file or system.

You can export assets or complex relations to a CSV or XLSX file. The exported file is very similar to the data you view in the table on the screen.

All relevant properties of a table are taken into account in an export:

- **Filters:** Determine which assets are exported.
- **Columns:** Determine which information about assets is exported.
- **Sorting:** Determine the order in which the assets are exported.

Note Exporting and importing assets and complex relations is restricted by the file upload settings, which determine the maximum file size, allowed file extensions and maximum amount of uploads and downloads per day. Contact [Collibra support](#) if you want to change the file upload settings.

Export assets

You can export assets from a [view](#). For example, this is useful if you want to create an overview in Excel.

Note Exporting and importing assets and complex relations is restricted by the file upload settings, which determine the maximum file size, allowed file extensions and maximum amount of uploads and downloads per day. Contact [Collibra support](#) if you want to change the file upload settings.

Steps

1. Navigate to the asset table that you want to export.
Example: Business Glossary
2. Above the table, to the right, click  > **Assets**.
» The **Export** dialog box appears.
3. Enter the required information.

Field	Description
View	Choose the view that you want to export. By default, your current view is filled in as view to export.
Add the characteristic needed for reimport. (ID, Domain, Community, ...)	Select if you want to reimport the export file later. By default, the export file only contains the characteristics that are displayed in the view. If you select this field, the export file will contain additional columns that are needed for the reimport.

Field	Description
Remove text formatting.	<p>Select this to remove any formatting of attributes in the import file.</p> <div style="border-left: 2px solid red; padding-left: 10px; background-color: #f0f0f0;"> <p>Warning Removing text formatting may create problems while reimporting. During the reimport, column names are not automatically mapped to prevent overwriting of formatted text. You can manually map the columns, but then you lose formatting.</p> </div>
File name	<p>Type the name of the export file.</p> <p>By default, the name of the export file is set to the name of the view.</p>
File type	<p>Choose the file type of the export.</p> <p>By default, the exported file type is XLSX, but you can change it to CSV.</p>
Sheet name	<p>Type the name of the sheet in the export file.</p>

4. Click **Export**.
 - » A progress message is displayed. You can send this message to the background by closing it.
 - » When the export is finished, the export file is downloaded according to the settings of your web browser.
5. Close the progress message.

Export complex relations

You can export [complex relations](#). They have to be represented differently in a table structure than assets. For that reason, the export of complex relations is handled differently.

Note Exporting and importing assets and complex relations is restricted by the file upload settings, which determine the maximum file size, allowed file extensions and maximum amount of uploads and downloads per day. Contact [Collibra support](#) if you want to change the file upload settings.

Steps

1. Navigate to the asset table that you want to export.
Example: Business Glossary
2. Above the table, to the right, click  > **Complex Relations**.
» The **Export** dialog box appears.
3. Enter the required information.

Field	Description
Complex Relation Type	Choose the type of the complex relations that you want to export.
Add the characteristic needed for reimport. (ID, Domain, Community, ...)	Select if you want to reimport the export file later. By default, the export file only contains the characteristics that are displayed in the view. If you select this field, the export file will contain additional columns that are needed for the reimport.
Remove text formatting.	Select this to remove any formatting of attributes in the import file. <div style="border-left: 2px solid red; padding-left: 10px; margin-top: 10px;"> <p>Warning Removing text formatting may create problems while reimporting. During the reimport, column names are not automatically mapped to prevent overwriting of formatted text. You can manually map the columns, but then you lose formatting.</p> </div>

Field	Description
File name	Type the name of the export file. By default, the name of the export file is set to the name of the view.
File type	Choose the file type of the export. By default, the exported file type is XLSX , but you can change it to CSV .
Sheet name	Type the name of the sheet in the export file.

4. Click **Export**.
 - » A progress message is displayed. You can send this message to the background by closing it.
 - » When the export is finished, the export file is downloaded according to the settings of your web browser.
5. Close the progress message.

Export dialog box for complex relations

Field	Description
Complex Relation Type	The complex relation type that you want to export.
Add the characteristic needed for reimport. (ID, Domain, Community, ...)	By default, the export file only contains the characteristics that are displayed in the view. By selecting this check box, you can add a column for ID characteristics. These characteristics help to identify specific resources during an import.

Field	Description
Remove text formatting.	<p>By default, the export file contains the raw content of text attributes, including text markup. By selecting this check box, you can remove most of the text formatting from exported attributes.</p> <p>If you choose to remove text formatting, it is better not to import the unformatted text. To prevent the overwriting of formatted text, Collibra DGC ensures that the column names are not automatically mapped while you are importing a file that was exported without text formatting.</p>
File name	By default, the name of the export file is set to the name of the view. You can give the file any name you like, however.
File type	By default, the exported file type is <code>.xls</code> , but you can change it to <code>.csv</code> if you prefer.
Sheet name	Name of one of the sheets in an Excel or CSV file.

Update complex relations in bulk

If you want to make changes to multiple complex relations of the same type at once, follow these steps:

1. [Export](#) complex relations.
2. In the exported file, make the necessary changes.

Warning Do not change the ID values.

3. Save and close the file.
4. [Import](#) the complex relations.

In the mapping step, also map the **ID** field to the **Business Term Mapping - id** column in your exported file.

Diagrams

Diagrams allow you to show and interact with many assets and relations in an easy-to-read way. A diagram helps you to quickly see to which other assets a specific asset is related. Two assets are related if you can navigate from one to the other by traversing one or more relations.

You can find a diagram in the tab pane of every asset page.

You can work with diagrams in the [diagram editor](#), to determine how a diagram is shown. Collibra Data Governance Center comes with several packaged [diagram views](#) for common use cases. You can also create and share your own diagram views.

For complete information on diagrams, see the [Documentation Center](#).

Example

The image below shows a diagram with assets, relations and complex relations.

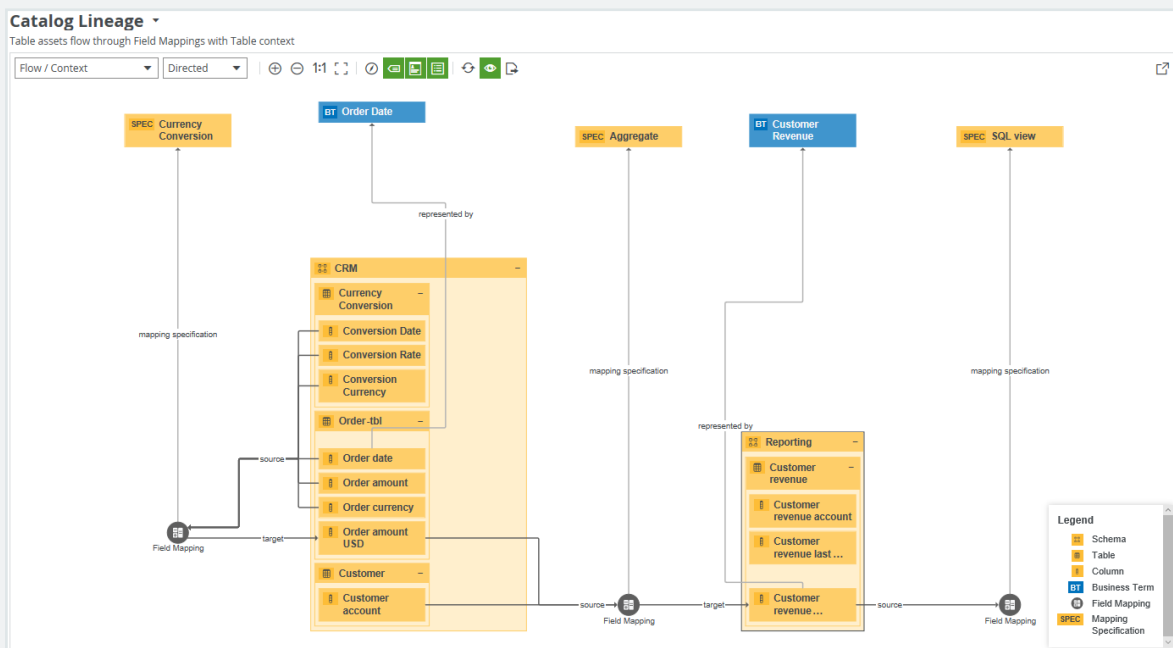

In this chapter

Diagram and diagram view terminology

To work with diagrams and diagram views, you have to understand the following concepts.

Concept	Description
Diagram	The diagram that results from applying a diagram view to a given asset. It sometimes also called "result diagram".
Diagram view	<p>A kind of query that determines which nodes and edges have to be shown in a diagram for a given asset.</p> <p>The diagram view also determines how the nodes and edges are shown.</p> <p>You can define multiple diagram views for the same asset type.</p>
Loop	<p>A diagram view that contains a path that revisits the same node. For example, [Business Asset] groups [Business Asset], or [Data Element] sources [Field Mapping], [Field Mapping] targets [Data Element].</p> <p>A diagram view with a loop can lead to a diagram that has very long paths.</p>
Node	<p>In a diagram, a node is an asset or a complex relation.</p> <div style="background-color: #f0f0f0; padding: 10px; border: 1px solid #ccc;"> <p>Note</p> <ul style="list-style-type: none"> • The node for an asset is depicted by a rectangle. • The node for a complex relation is depicted by a circle or a rectangle with rounded corners. </div>
Boxed node	A node that is contained inside a boxing node. For example, a Column asset can be boxed by a Table asset.

Concept	Description
Boxing node	<p>A node that contains one or more boxed nodes. If it is expanded, you can see the boxed nodes. If it is collapsed, you cannot see the boxed nodes.</p> <p>For example, a Table asset can box multiple Column assets.</p>
Locked node	<p>A collapsed boxing node that cannot be expanded.</p>
Incoming relation	<p>An incoming relation of a node is when the selected node is the tail side of the relation type, in other words, an edge for which this node is the 'to' node.</p> <p>For example, the relation [Business Term] has code / is code for [Code Value] is incoming for a Code Value.</p>
Outgoing relation	<p>An outgoing relation of a node is when the selected node is the head side of the relation type, in other words, an edge for which this node is the 'from' node.</p> <p>For example, the relation [Business Term] has code / is code for [Code Value] is outgoing for a Business Term.</p>
Edge	<p>In a diagram, an edge is a directed relation between two nodes. The word 'directed' indicates that the direction in which the relation is used is relevant for the diagram.</p> <p>An edge is normally depicted by an arrow between two nodes. The arrow points to the 'to' node. It can also be represented by means of boxing and boxed nodes, in which one node contains the other.</p>
Flow	<p>The entire course of nodes and edges from the start node to the end node.</p>

Concept	Description
Context	A collection of nodes that does not belong in the flow. The nodes have an incoming edge from a flow node. For example, nodes that represent a System asset can be context nodes.
Overlay	An overlay is a characteristic of a node that is shown in the diagram. Overlays are added in a diagram view and can be shown or hidden via the diagram toolbar .
Traversal strategy	The logic that describes which relations and assets are included in the diagram.

Nodes and edges

Nodes and edges are the fundamental building blocks of diagrams and diagram views:

- In diagrams, nodes are rectangles or circles that represent, respectively, assets or complex relations. Edges represent relations between assets or between assets and complex relations.
- In diagram views, nodes are rectangles or circles that represent, respectively, asset types or complex relation types. Edges represent relation types between asset types or between asset types and complex relation types.

Both nodes and edges can be represented in different ways in diagrams and diagram views.

Relations connect assets, or assets and complex relations. In diagrams, this is represented by edges that connect nodes. Each node can have incoming and outgoing edges:

- An edge of a node is incoming if that node is the 'to' node of the edge. This depends on the relation type and the direction of the edge:
 - The node is the tail side of the relation type, and the edge has the role direction.
 - The node is the head side of the relation type, and the edge has the co-role direction.

- An edge of a node is outgoing if that node is the 'from' node of the edge. This depends on the relation type and the direction of the edge:
 - The node is the head side of the relation type, and the edge has the role direction.
 - The node is the tail side of the relation type, and the edge has the co-role direction.

Example

Consider the diagram below:



- The red node represents a Tableau Data Source asset.
- The blue node represents a Tableau Workbook asset.
- The arrow edge between the nodes represents a relation of the type "Tableau Data Source is source of / is source for Tableau Workbook".
 - The edge is outgoing for the Tableau Data Source node.
 - The edge is incoming for the Tableau Workbook node.

Node and edge styles

Edges represent relations, which in turn describe a link between assets. To represent the meaning of those links in a diagram, edges can be represented in different ways.

Depending on the meaning of the relation, you can choose which edge style suits best.

- Arrow: The most basic way to represent an edge is by means of an arrow. This representation is ideal for visualizing flows and causal relations.

Example



- Boxed and boxing: Many relation types are used to describe a part-whole relation, such as "Tableau Project groups / is grouped by Report". For that reason, you can also represent the relation between those assets as boxing nodes and boxed nodes.

A node that has an outgoing edge of the boxing style, becomes a boxing node. For the boxed node, the same edge is an incoming edge of the boxed style. Additionally, one boxing node could contain several boxed nodes, which have edges of their own.

Boxing nodes can be expanded or collapsed:

- An expanded boxing node shows its boxed nodes. You can collapse them by clicking **−** in the upper right corner of the node.
- A collapsed boxing node does not show its boxed nodes. As a consequence, if the hidden boxed nodes have arrow edges to nodes that are not contained by the boxing nodes, the diagram shows them as arrow edges of the boxing node. You can expand them by clicking **+** in the upper right corner of the node.
- A locked node is a collapsed node that cannot be expanded. You can recognize locked boxing nodes by the **🔒** in the upper right corner. You can still explore the nodes to see the edges.

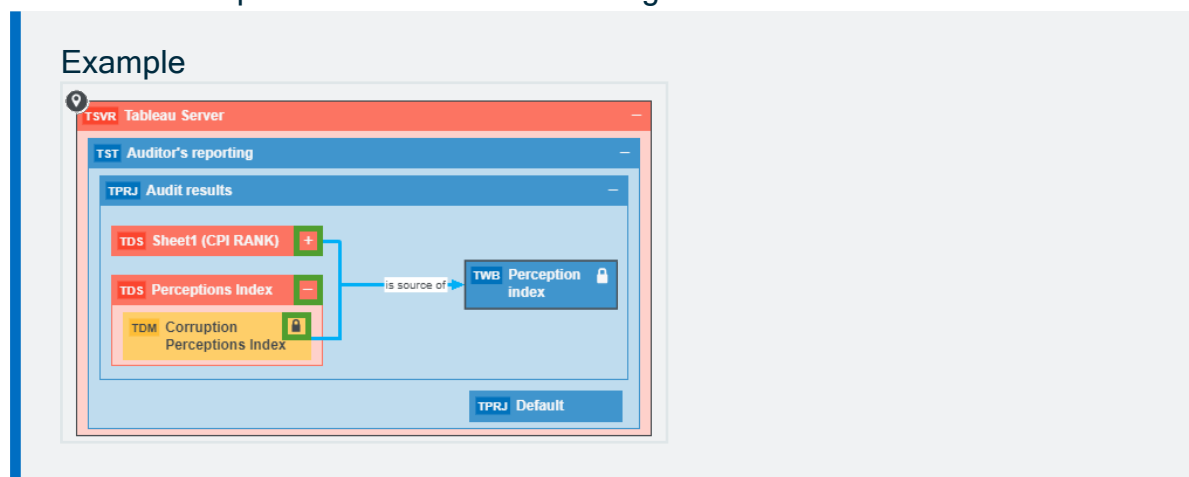

Duplicate nodes

In some cases, the same asset might be represented by more than one node. In other words, there are two nodes representing the same asset, on the same diagram. This can be caused by several of reasons, but the most common reason is that an asset matches more than one node of the diagram view.

A node in a diagram view represents an asset type or a complex relation type. In the result diagram, this node represents an asset of that asset type or an asset of a child asset type. As a result, if a diagram view contains a node for an asset type and a node for its child

asset types, the result diagram may contain an asset of the child asset type that matches both nodes of the diagram view. Therefore, the asset node is duplicated.

Example

Suppose the following situation;

- The Business Process asset type has two child asset types: Business Phase and Milestone.
- You have the following assets:
 - Business Process asset: Define Strategy
 - Business Phase asset: Plan
 - Milestone asset: Validate Strategy
- Your assets have the following relations:
 - Plan Business Phase has subprocess Define Strategy Business Process
 - Plan Business Phase has Milestone: Validate Strategy Milestone
 - Define Strategy Business Process Next: Validate Strategy Milestone
- The diagram view configuration is the following:
 - The Business Process node has a boxing edge: Business Process has subprocess Business Phase.
 - The Business Phase node has two boxing edges:
 - Business Phase has subprocess Business Process 2
 - Business Phase has Milestone
 - Business Process 2 node has an arrow edge: Business Process 2 Next Business Process 2.

This leads to the following diagram view:

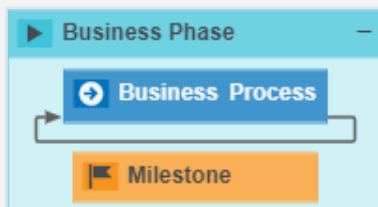

Because the Business Process asset type has two child asset types that are also on the diagram view, the result diagram can have duplicate nodes. In the example below, the Validate Strategy asset, of the Milestone asset type, is represented by two separate nodes.

Because Milestone is a child asset type of Business Process, Milestone assets can match both Milestone nodes and Business Process nodes. Furthermore, the Validate Strategy Milestone asset has two separate incoming edges:

- The Plan Business Phase has Validate Strategy Milestone, with the boxing style.

- The Define Strategy Business Phase asset Next Validate Strategy, with the arrow style.

Therefore, the Validate Release Strategy Milestone node is duplicated:

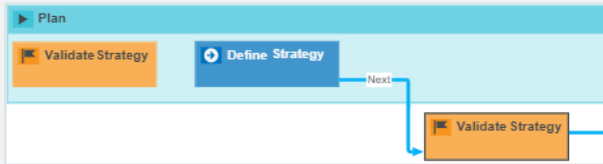

Diagram layouts

Diagram layouts determine the location of nodes and edges in a [diagram](#), but do not change which nodes and edges are shown.

You can [select](#) a diagram layout in the [diagram toolbar](#).

Diagram layout	Description
Flow / Context	<p>Nodes and edges are shown in a flow and a context region.</p> <p>In the flow region, nodes are shown mostly from left to right.</p> <p>The context region is shown above the flow region. The edges that begin or end with a node in the context region are shown with less emphasis (thinner and light gray). You can choose which nodes are in the context region by selecting the Context checkbox in the node properties form.</p> <p>If there are no nodes in the context region, this layout produces the same result as Hierarchy left -> right.</p> <div style="border: 1px solid gray; padding: 5px; margin-top: 10px;"> <p>Note For an edge between a flow node and a context node, the 'from' node must be in the flow region and the 'to' node in the context region.</p> </div>
Hierarchy left - right	<p>Nodes and edges are shown in a flow, predominantly from left to right. This is the default layout.</p>

Diagram layout	Description
Hierarchy top - down	Nodes and edges are shown in a flow, from top to bottom.
Hierarchy bottom - up	Nodes and edges are shown in a flow, from bottom to top.
Circular	<p>Nodes and edges are arranged in a circular fashion.</p> <p>Boxing nodes are not supported in this layout, therefore:</p> <ul style="list-style-type: none"> • The diagram is completely redrawn. • The explored nodes are removed from the diagram. • The nodes expand or collapse to their initial state. • Returning to a layout that supports boxing nodes completely redraws the diagram.
Radial	<p>Nodes and edges are shown in a radial fashion, with no overlaps, few edge crossings and few bends.</p> <p>Boxing nodes are not supported in this layout. This has the same consequences as described for the Circular layout.</p>
Smart Organic	Nodes and edges are distributed in a well-balanced manner, with few edge crossings.

Traversal strategies

A traversal strategy determines which nodes and edges are traversed and displayed in a [diagram](#).

The [diagram view](#) determines the initial traversal strategy, but you can [select](#) another one in the [diagram toolbar](#).

Traversal strategy	Description
End-to-end	<p>For the start node, Collibra Data Governance Center traverses the relations of the types that occur in the diagram in all directions, incoming and outgoing, and adds all the nodes and edges that it encounters to the diagram.</p> <p>For each encountered node, Collibra DGC traverses the relations only in the same direction as that in which they were encountered. If a node was encountered while traversing an outgoing relation, Collibra DGC looks for outgoing relations of that node and vice versa. This behavior is like traversing a hierarchy.</p> <p>This is the default traversal strategy.</p>
Upstream	<p>For the start node, only the incoming edges are traversed and shown.</p> <p>For each node encountered, only the incoming edges are traversed.</p>
Downstream	<p>For the start node, only the outgoing edges are traversed and shown.</p> <p>For each node encountered, only the outgoing edges are traversed.</p>
Complete	<p>For the start node, the relations are traversed in both directions. All encountered nodes and edges are added to the diagram.</p> <p>For each encountered node, both incoming and outgoing edges are traversed. Essentially, this means that each encountered node is treated as a start node.</p> <div data-bbox="432 1554 1417 1697" style="border-left: 2px solid red; background-color: #f0f0f0; padding-left: 10px;"> <p>Warning This strategy can result in a very large diagram that can take a long time to load.</p> </div>

Diagram editor

The diagram editor allows you to view and edit [diagrams](#).

Catalog Lineage ▼





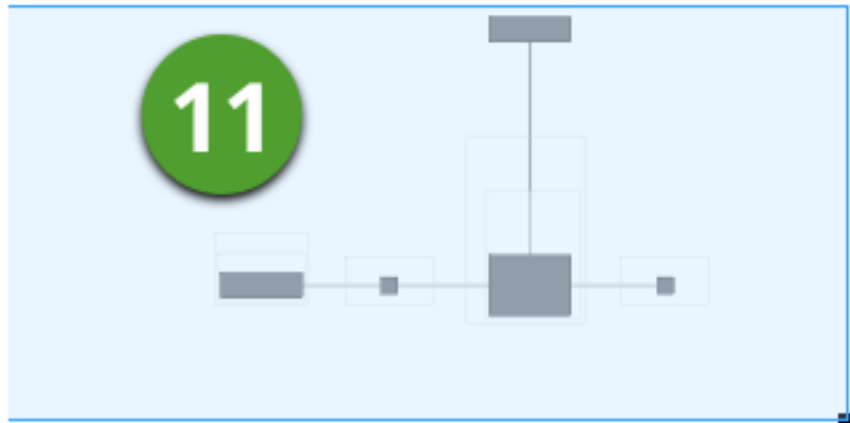

Table assets flow through Field Mappings with Table context



Flow / Context ▼ Directed ▼ Business qualifier ▼ 5



- CRM ▼
 - Customer ▼
 - Customer account so

No	Name	Description
1	View title	The name and description of the current diagram view . You can select a different view from a list of pinned and applicable views for an asset of this type. You can open the list of views when you click the view name and then Show all .
2	Diagram toolbar	The toolbar to work with the diagram.
3	View bar menu	The buttons to manage the diagram view.
4		The button to create a new diagram view, starting from the selected node.
5		The button to edit the current diagram view.
6		The button to edit the name and description of the current diagram view.
7		The button to save the diagram view as a new view.
8		The button to share the diagram view.
9		The button to delete the diagram view.
10	Diagram	This is the actual depiction of the traceability of the current asset, according to the selected diagram view .
11	Overview ()	The box to zoom and navigate a diagram that is too large to fit the screen. You can move it to anywhere in the diagram.

No	Name	Description
12	Legend	<p>The legend explains the color codes and symbols of the items in the diagram. You can move it to anywhere in the diagram.</p> <p>For each asset type and complex relation type that is visible on the diagram, the legend shows the color and symbol, followed by the name of the type.</p> <p>If all occurrences of a given type are boxed inside collapsed boxing nodes, that type is not visible and therefore, not shown in the legend.</p> <div style="border: 1px solid #ccc; background-color: #f9f9f9; padding: 10px; margin-top: 10px;"> <p>Tip Click a row in the legend to select all occurrences of that type in the diagram. You can use this to expand or collapse all nodes of the same type.</p> </div>
13	Preview panel	The preview panel with information about the selected node.







Diagram toolbar

The toolbar of the [diagram editor](#) helps you to edit settings that apply to the entire [diagram](#).



Button	Name	Description
<input type="text" value="Hierarchy left - right"/>	Layout	Select a layout . The layout determines the location of nodes and edges, but does not change which nodes and edges are shown.
<input type="text" value="End-to-end"/>	Traversal strategy	Select a traversal strategy to change which nodes and edges are shown in the diagram.

Button	Name	Description
	Flow depth	Specify the flow depth , meaning the flow relation path length from the start flow node set to any other flow node.
	Business qualifier	Filter a diagram to contain only assets that are qualified by a chosen business qualifier .
	Zoom in	Zoom in on the diagram.
	Zoom out	Zoom out of the diagram.
1:1	Zoom to readable value	Zoom the diagram to a size that is readable.
	Shrink to fit	Zoom the diagram to a size that fits the screen.
	Overview	Show or hide the overview inset that enables you to zoom and navigate.
	Labels	Show or hide the labels of the edges and complex relations.
	Overlays	Show or hide overlays for all nodes in the diagram . If the view does not have any defined overlays, the button is grayed out.
	Export	Export the diagram as a PDF or SVG file to your default downloads folder.
	Redraw	Discard all the changes that you made to the diagram and restore it to the initial state.

Button	Name	Description
	Legend	<p>Show or hide the legend panel containing the explanation of the nodes.</p> <p>The legend explains the color codes and symbols of the items in the diagram. You can move it to anywhere in the diagram.</p> <p>For each asset type and complex relation type that is visible on the diagram, the legend shows the color and symbol, followed by the name of the type.</p> <p>If all occurrences of a given type are boxed inside collapsed boxing nodes, that type is not visible and therefore, not shown in the legend.</p> <div style="border-left: 2px solid #00b050; padding-left: 10px; margin-top: 10px;"> <p>Tip Click a row in the legend to select all occurrences of that type in the diagram. You can use this to expand or collapse all nodes of the same type.</p> </div>
	Preview	Show or hide the preview panel on the right side of the screen. It contains information about the characteristics of the currently selected node (asset or complex relation).
	Filter	<p>Enable or disable all filters in the diagram view.</p> <p>If the view does not have any defined filters, the button is grayed out.</p>
	Picture	Create a picture based on the diagram.
	Find	Find a node in the diagram.
	Fullscreen	Show the current diagram in full-screen mode. The button changes to  , to exit full-screen mode.

The diagram preview panel

The preview panel offers a quick overview of the node that you select in the [diagram](#). The content of the preview panel depends on the type of node that you select in the diagram:

Assets	Complex relations
<ul style="list-style-type: none"> • Breadcrumbs • Name of the asset • Asset type code or icon, as described in Edit an asset type's representation. <div style="border-left: 2px solid green; padding-left: 10px; margin: 10px 0;"> <p>Tip You can hover over the code or icon to view the asset type.</p> </div> <ul style="list-style-type: none"> • Status • Created on • Last modified • All assigned characteristics • Tags 	<ul style="list-style-type: none"> • All assigned characteristics • Last modified by (user), with date and time • Created by (user)

To open or close the diagram preview panel

1. [Open](#) a diagram.
2. On the [diagram toolbar](#), click .

3. Optionally, click the node that you want to preview.
 - » The **preview panel** appears or disappears.

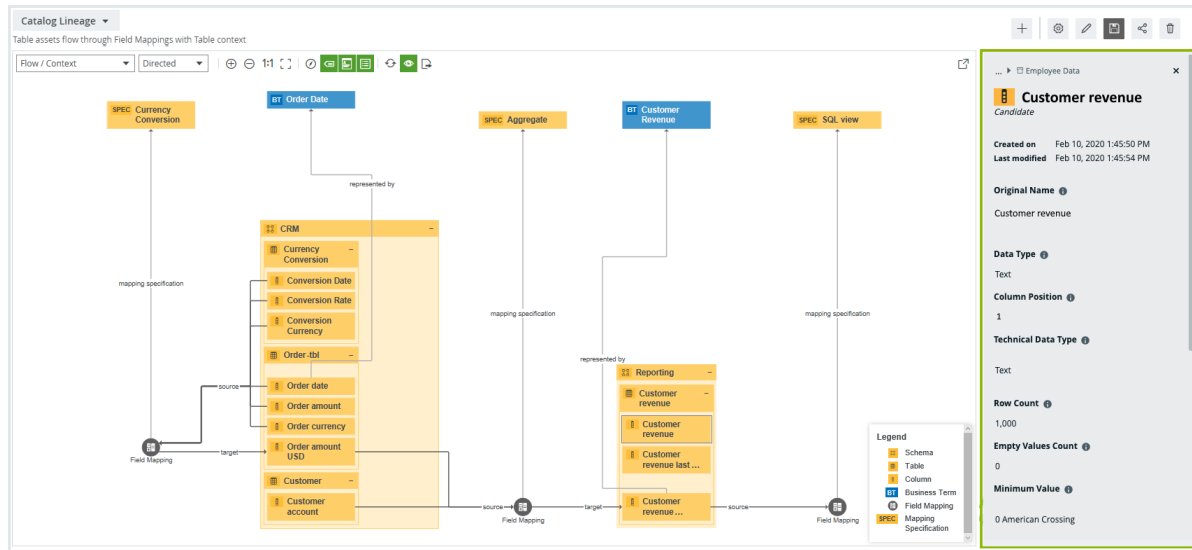

Working with diagrams

The diagram is a feature to show and interact with many assets and relations in an easy-to-read diagram. The diagram helps you to quickly see to which other assets a specific asset is related. Two assets are related if you can navigate from one asset to another by traversing one or more relations.

Summary diagrams

Depending on the diagram view, diagrams can contain a large number of **nodes and edges**. Opening a diagram with many nodes can take a long time. All nodes and edges are important to render the diagram correctly, but you don't always need to see every single node. Often, the diagram is only used to show the high-level outcome.

Summary diagrams contain high-level nodes that are locked. Locked nodes are boxed nodes that cannot be expanded. The low-level boxed nodes and their edges are taken into account to show the edges of the locked nodes, but the diagram requires less loading time.

Example

The following example shows a summary diagram that contains two locked nodes, representing System assets. These System assets can have a lot of relations. In a regular diagram this would take a lot of time to load. However, because these nodes are locked on this summary diagram, it loads faster.

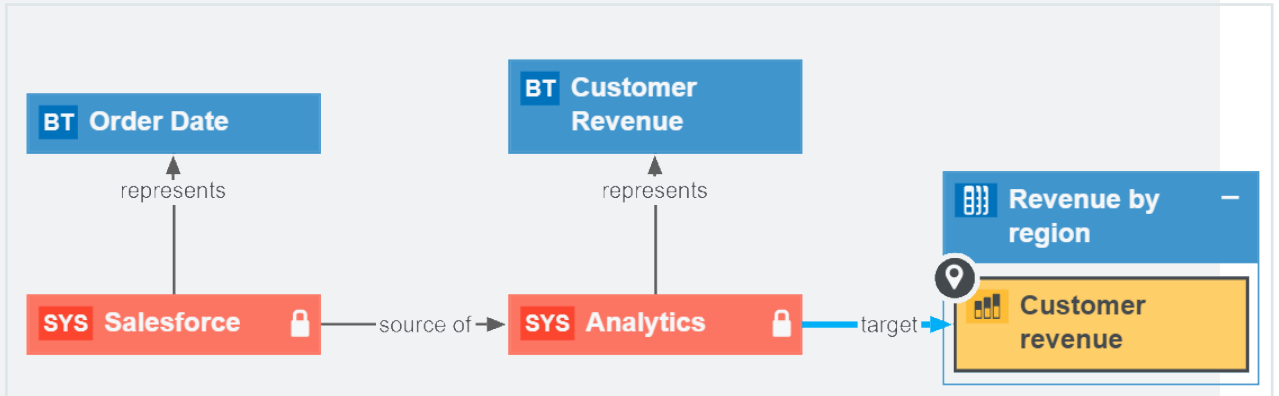

Open a diagram

You can open a [diagram](#) of an asset to visualize its relations.

Steps

1. Open an asset page.
2. In the tab pane, click  **Diagram**.
 - » The diagram appears in the default [diagram view](#).
3. If necessary, [select](#) a different diagram view.

Tip If a diagram exceeds the size or time limit set by your administrator, an error notification is shown. In this case, you can try to edit the diagram view to reduce the number of nodes and edges or ask your administrator to increase the diagram limits.

Open another node's diagram

You can open a [diagram](#) for another node in the [diagram](#) you have currently open. This action also opens the asset page of the selected node.

Tip You can return to the initial diagram by using the back button of your browser.

Steps

1. [Open](#) a diagram.
2. Select a node.
3. In the context menu, point to **Start here**.
 - » The available diagram views appear.
4. Click one of the diagram views.

Clicking **Start here** opens another node's diagram in the same diagram view.

 - » The diagram view of selected node's asset page appears.



Open a business qualifier diagram

You can open a [business qualifier diagram](#), meaning a diagram that contains only assets or complex relations that are qualified by a chosen Business Qualifier asset.

Prerequisites

- The Diagrams Business Qualifier Filter is [enabled](#) in Colibra Console.
- A **Filtering by business qualifier** option (either Optional or Mandatory) is selected for at least one node in the selected diagram view.
- Either the start node is a Business Qualifier asset, or both of the following are true:
 - The start node matches a view node that has a **Filtering by business qualifier option** (either Optional or Mandatory) selected.
 - The start node has at least one [Business Qualifier path](#).

Steps

1. Open the asset page of a Business Qualifier asset.
2. In the tab pane, click  **Diagram**.
 - » The diagram appears in the default [diagram view](#).
3. If necessary, [select](#) a different diagram view.
 - » The diagram view must be a [business qualifier view](#), meaning a view with at least one node for which a **Filtering by business qualifier** option is selected.
4. In the Diagram toolbar, click , to enable all filters in the diagram view.
5. In the Business Qualifier drop-down list, select the relevant Business Qualifier asset.
 - » The diagram is filtered to contain only the assets or complex relations that are qualified by the selected Business Qualifier asset.

Open an asset page from a diagram

You can open an [asset page](#) while you are viewing a [diagram](#) without closing it.



Steps

1. [Open](#) a diagram.
2. Right-click the node of which you want to view the asset page.
3. In the context menu, click **Open in new tab**.
 - » The asset page opens on the diagram page.

Find node in a diagram

You can search a [diagram](#) for a specific node.

Steps

1. [Open](#) a diagram.
2. On the toolbar, click .
 - » The search box appears.

The image shows a search box with a magnifying glass icon on the left, a close button (X) in the middle, and a counter '13 of 13' followed by left and right arrow icons on the right.
3. Start typing in the search box.
 - » The counter next to the search box indicates how many matches are found.

- » The first match is selected in the diagram.

Tip You can use the arrows to navigate between the matches.

Export a diagram

You can export a [diagram](#) to a PDF or SVG file.

Steps

1. [Open](#) a diagram.
2. Make the necessary changes to the diagram.
 - a. [Select](#) a view.
 - b. [Select](#) a layout.
 - c. [Select](#) a traversal strategy.
 - d. Filter by [business qualifier](#). See [Work with filters in a diagram view](#).
 - e. [Adjust](#) the flow depth.
 - f. [Zoom](#) in or out.
 - g. [Explore](#) nodes.
 - h. [Expand or collapse](#) nodes.
 - i. [Trace](#) a path between nodes.
 - j. [Move](#) nodes, enable or disable labels, the legend, and so on.
3. On the toolbar, click  and select **PDF** or **SVG**.
 - » The resulting file is automatically downloaded to your default downloads folder.
 - » The default file name is **diagram.pdf** or **diagram.svg**.

Start a workflow for a node in the diagram

You can start a [workflow](#) from nodes in a [diagram](#), if the workflow is assigned to the relevant asset type.

Steps

1. [Open](#) a diagram.
2. Select a node.
3. In the context menu, point to **Actions**.
 - » A submenu appears with the available workflows.
4. Click the workflow that you want to start.

Note

- Workflows that have already been started are not listed.
- If there are no workflows available, **Actions** is grayed out.

Edit a diagram

You can edit a [diagram](#) to represent the nodes as clearly as possible.

Steps

1. [Open](#) a diagram.
2. Make the necessary changes to the diagram.
 - a. [Select](#) a view.
 - b. [Select](#) a layout.
 - c. [Select](#) a traversal strategy.
 - d. Filter by [business qualifier](#). See [Work with filters in a diagram view](#).
 - e. [Adjust](#) the flow depth.
 - f. [Zoom](#) in or out.
 - g. [Explore](#) nodes.
 - h. [Expand or collapse](#) nodes.
 - i. [Trace](#) a path between nodes.
 - j. [Move](#) nodes, enable or disable labels, the legend, and so on.

Select a diagram layout

You can select a [diagram layout](#) to change the way nodes are shown in a [diagram](#).

Steps

1. [Open](#) a diagram.
2. On the toolbar, click the layout box and select a layout.

Diagram layout	Description
Flow / Context	<p>Nodes and edges are shown in a flow and a context region.</p> <p>In the flow region, nodes are shown mostly from left to right.</p> <p>The context region is shown above the flow region. The edges that begin or end with a node in the context region are shown with less emphasis (thinner and light gray). You can choose which nodes are in the context region by selecting the Context checkbox in the node properties form.</p> <p>If there are no nodes in the context region, this layout produces the same result as Hierarchy left -> right.</p> <div style="border: 1px solid #ccc; background-color: #f9f9f9; padding: 10px; margin-top: 10px;"> <p>Note For an edge between a flow node and a context node, the 'from' node must be in the flow region and the 'to' node in the context region.</p> </div>
Hierarchy left - right	Nodes and edges are shown in a flow, predominantly from left to right. This is the default layout.
Hierarchy top - down	Nodes and edges are shown in a flow, from top to bottom.
Hierarchy bottom - up	Nodes and edges are shown in a flow, from bottom to top.

Diagram layout	Description
Circular	<p>Nodes and edges are arranged in a circular fashion.</p> <p>Boxing nodes are not supported in this layout, therefore:</p> <ul style="list-style-type: none"> ◦ The diagram is completely redrawn. ◦ The explored nodes are removed from the diagram. ◦ The nodes expand or collapse to their initial state. ◦ Returning to a layout that supports boxing nodes completely redraws the diagram.
Radial	<p>Nodes and edges are shown in a radial fashion, with no overlaps, few edge crossings and few bends.</p> <p>Boxing nodes are not supported in this layout. This has the same consequences as described for the Circular layout.</p>
Smart Organic	<p>Nodes and edges are distributed in a well-balanced manner, with few edge crossings.</p>

Tip You can go back to the initial diagram by clicking . Keep in mind that all your changes are discarded if you do this.

Select a traversal strategy

You can select a [traversal strategy](#) to determine which nodes and edges are traversed and displayed in a [diagram](#).

Note If you change the traversal strategy, the diagram is completely redrawn and explored nodes are removed.

Steps

1. [Open](#) a diagram.
2. On the diagram toolbar, click the traversal strategy box and select a traversal strategy.

Traversal strategy	Description
End-to-end	<p>For the start node, Collibra Data Governance Center traverses the relations of the types that occur in the diagram in all directions, incoming and outgoing, and adds all the nodes and edges that it encounters to the diagram.</p> <p>For each encountered node, Collibra DGC traverses the relations only in the same direction as that in which they were encountered. If a node was encountered while traversing an outgoing relation, Collibra DGC looks for outgoing relations of that node and vice versa. This behavior is like traversing a hierarchy.</p> <p>This is the default traversal strategy.</p>
Upstream	<p>For the start node, only the incoming edges are traversed and shown.</p> <p>For each node encountered, only the incoming edges are traversed.</p>
Downstream	<p>For the start node, only the outgoing edges are traversed and shown.</p> <p>For each node encountered, only the outgoing edges are traversed.</p>

Traversal strategy	Description
Complete	<p>For the start node, the relations are traversed in both directions. All encountered nodes and edges are added to the diagram.</p> <p>For each encountered node, both incoming and outgoing edges are traversed. Essentially, this means that each encountered node is treated as a start node.</p> <div data-bbox="504 667 1417 808" style="border-left: 2px solid red; padding-left: 10px; background-color: #f0f0f0;"> <p>Warning This strategy can result in a very large diagram that can take a long time to load.</p> </div>

Adjust the flow depth in a diagram

To help you control the size of business diagrams, you can adjust the [flow depth](#), the flow relation path length from the start flow node set to any other flow node.

Tip You can also:

- Contact [Collibra support](#) to edit system-wide maximum flow depth.
- [Specify](#) the maximum flow depth in a diagram view.

For complete information on related terminology and functionality, see [Maximum flow depth](#).

Steps

1. [Open](#) a diagram view.
2. In the **Flow depth** field of the [diagram toolbar](#), enter a value between 0 and 99.
3. Click **Save**.

Working with the diagram overview inset

The overview inset of the [diagram editor](#) allows you to keep an overview of the complete [diagram](#), while the main screen is showing only a section of it.

Steps

1. [Open](#) a diagram.
2. On the toolbar, click the  to show or hide the overview inset.
 - » The overview inset is shown over the diagram. You can still see the diagram underneath.
3. Do one of the following:

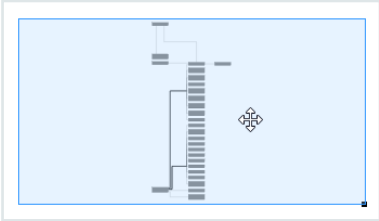
Action	Descriptions
Zoom in or out by scaling:	<ol style="list-style-type: none"> a. Move your mouse pointer over the lower right corner of the blue square, until it turns into a sleek slanted arrow. b. Click and hold, then drag the pointer to zoom in or out. 
Navigate in the diagram:	<ol style="list-style-type: none"> a. Move your mouse pointer over the blue square. The pointer turns into a four-way arrow. b. Click and hold, then drag the pointer to move the square to what you want to see. 

Zoom in or out in the diagram editor

When working with [diagrams](#), you can zoom in or out in different ways.

Steps

1. [Open](#) a diagram.
2. Do one of the following:

Strategy	Description
Zoom in or out with buttons.	On the toolbar, click ⊕ (Zoom in) or ⊖ (Zoom out) as needed.
Zoom in or out by scrolling with your mouse.	Move your mouse pointer to anywhere on the diagram and use your mouse wheel to zoom. The zoom is centered at the mouse pointer.
Zoom in or out by scaling.	<p>a. On the toolbar, click the  button (Overview). An overview inset with a miniature version of the entire diagram is shown in the top right corner. The section of the diagram that is shown on the screen is visible as a blue rectangle on the overview.</p> <p>b. Move your mouse pointer over the lower right corner of the blue rectangle, until it turns into a sleek slanted arrow.</p> <div data-bbox="655 1435 1034 1655" data-label="Image"> <p>The image shows a diagram with a blue rectangle highlighting a specific section. In the top right corner, there is a smaller inset showing the entire diagram. A mouse pointer is positioned over the bottom right corner of the blue rectangle, and it has turned into a slanted arrow, indicating that the user can click and drag to zoom in or out of that area.</p> </div> <p>c. Click and hold, then drag the pointer to zoom in or out.</p>
Zoom to readable value.	On the toolbar, click 1:1.

Strategy	Description
Adapt the diagram to fit in the view.	On the toolbar, click  .

Explore nodes in a diagram

For each node in a [diagram](#), there might be relations that are not depicted in the diagram. This is the case if the type of relation is not in the [diagram view](#) or the relation is not traversed due to the selected [traversal strategy](#).

You can still add these relations and their nodes to the diagram, by 'exploring' the node.

Tip To remove the relations that you added to a node by using the explore mode, right-click the node and click **Remove explored**.

Steps

1. [Open](#) a diagram.
2. Select a node.
3. In the context menu, point to **Explore**.
 - » A submenu appears with the available relation types, and a count of how many relations exists for this type.
4. Click one of the relation types or group of relation types:

Mode	Description
All	Explore all relation types of the selected node. Clicking Explore in the context menu has the same result.

Mode	Description
Incoming	<p>Explore all incoming relations of the selected node.</p> <p>A relation is considered incoming when the selected node is the tail side of the relation type.</p> <p>For example, the relation <i>[Business Term] has code / is code for [Code Value]</i> is incoming for a <i>Code Value</i>.</p>
Outgoing	<p>Explore all outgoing relations of the selected node.</p> <p>A relation is considered outgoing when the selected node is the head side of the relation type.</p> <p>For example, the relation <i>[Business Term] has code / is code for [Code Value]</i> is outgoing for a <i>Business Term</i>.</p>
Any specific relation type	Explores the relations of the selected relation type.

Expand or collapse nodes

If a node has an outgoing edge with the boxing style, it becomes a boxing node. Your diagram view determines whether boxing nodes are expanded or collapsed by default. Your diagram view can also lock collapsed nodes, which means that you cannot expand the collapsed boxing node.

Tip Though you cannot expand locked nodes, you can explore them to see their boxed nodes.

Steps

1. [Open](#) a diagram.
2. Do one of the following:
 - Select a node.
 - Select multiple nodes by holding down the select key and clicking nodes.

On a macOS system	On a Windows system
Click the first one and then hold down <code>cmd</code> while clicking on the next ones.	Click the first one and then hold down <code>ctrl</code> while clicking on the next ones.

- In the legend, click the asset type or complex relation type that you want to expand or collapse. You have now selected all nodes of this type.
3. Do one of the following:
 - In the node, click `+` or `-`.
 - In the context menu of a node, click **Expand/Collapse selected**.

Trace all paths between nodes in the diagram

You can trace all paths between any number of nodes on the [diagram](#), which means you can show the relations between the nodes.

You can trace a path between nodes in the following ways:

- The highlight mode: Keep the whole diagram and highlight the nodes and edges on the path.
- The crop mode: Remove any node or edge that is not on the path.

Steps

1. [Open](#) a diagram.
2. Select one, two or more nodes in the diagram:

On a macOS system	On a Windows system
Click the first one and then hold down <code>cmd</code> while clicking on the next ones.	Click the first one and then hold down <code>ctrl</code> while clicking on the next ones.

3. Do one of the following:
 - To keep the whole diagram and highlight the path, right-click one of the selected nodes and click **Trace path → Highlight**.
 - To remove anything that is not part of the path between the two selected nodes, right-click one of the nodes and click **Trace path → Crop**.
 - » If you selected a single node, all relations are traced.
 - » If you selected multiple nodes, the path between the selected nodes is traced.
 - » If there is no path between the nodes, a message is displayed.

Move a node in the diagram

If you want a node to be in a different location in the [diagram](#), you can easily move it around.

Steps

1. [Open](#) a diagram.
2. Click a node and hold down your mouse button. To select multiple nodes, do the same but select multiple nodes.

On a macOS system	On a Windows system
Click the first one and then hold down <code>cmd</code> while clicking on the next ones.	Click the first one and then hold down <code>ctrl</code> while clicking on the next ones.

3. Move the node to where you want it and release the mouse button.

Note You cannot save these changes, but you can [create](#) a picture or [export](#) the diagram with these changes.

Diagram views

In this section, you can find more information about what you can do with diagram views.

Create a diagram view



You can create your own [diagram views](#):

- [From scratch](#).
- [From an existing view](#).

Create a diagram view from scratch

1. Open an asset page.
2. In the tab pane, click  **Diagram**.
 - » The diagram appears in the default diagram view.
3. Click **+** to add a new view.
4. [Edit](#) the diagram view.

Create a diagram view from an existing view

1. Open an asset page.
2. In the tab pane, click  **Diagram**.
 - » The diagram appears in the default diagram view.
3. If required, [select](#) another diagram view.
4. Click .
 - » The **Save view as** dialog box appears.

5. Enter the required information.

Field	Description
Name*	Type a name for the diagram view.
Description	Type a description for the diagram view.
Sharing options	This section determines who has access to this diagram view.
Public	Select to share this diagram view with all users.
Private	Select to share this diagram view with no one.
Share with specific roles, groups & users	Select to choose with whom to share the diagram view.
Roles	Select or type the roles whose users you want to give access.
Groups	Select or type the groups whose users you want to give access.
Users	Select or type the users to whom you want to give access.
Promote	
Default	Select to use this diagram view as the default view when you open the diagram editor.
Pin	Select to pin the diagram view. Pinned diagram views appear in the view selection drop-down list.

Fields marked with a * are mandatory.

6. [Edit](#) the diagram view.

Open a diagram view

You can open a [diagram view](#) to view the [diagram](#) of an asset.

Steps

1. Open an asset page.
2. In the tab pane, click  **Diagram**.
 - » The diagram appears in the default diagram view.
3. If necessary, [select](#) a different diagram view.

Tip If a diagram exceeds the size or time limit set by your administrator, an error notification is shown. In this case, you can try to edit the diagram view to reduce the number of nodes and edges or ask your administrator to increase the diagram limits.

Note

- If the diagram depth is limited by a specified [maximum flow depth](#) value, a notification informs you that the diagram is incomplete.
- It's possible that an asset type or characteristic that is referenced in a diagram view was deleted from your Collibra DGC environment by another user. In this case, an error message appears and the invalid asset type or characteristic is amended with the word "Invalid", so that you can easily identify it and [edit](#) the diagram view as necessary.

Select a diagram view

To select to a different [diagram view](#), follow these steps:

1. Open a diagram view.
2. Do one of the following:

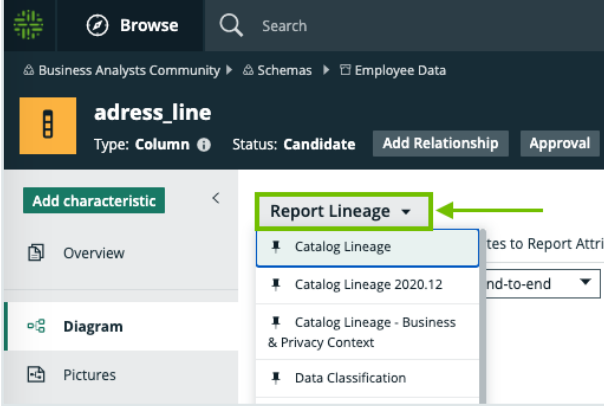
<p>Select a pinned view:</p>	<p>Click the current view name and select a view from the list of pinned views.</p> <p>Show me where to click.</p>  <p>The screenshot shows the 'Report Lineage' dropdown menu open, with a green box highlighting the 'Report Lineage' header and a green arrow pointing to it from the right. The dropdown list includes 'Catalog Lineage', 'Catalog Lineage 2020.12', 'Catalog Lineage - Business & Privacy Context', and 'Data Classification'. The background shows the 'adress_line' asset details page with 'Type: Column' and 'Status: Candidate'.</p>
<p>Select an unpinned view:</p>	<ol style="list-style-type: none"> a. Click the current view name and click Show all... at the bottom. b. Click on a view in the list of views that apply to an asset of this type.

Note It's possible that an asset type or characteristic that is referenced in a diagram view was deleted from your Colibra DGC environment by another user. In this case, an error message appears and the invalid asset type or characteristic is amended with the word "Invalid", so that you can easily identify it and [edit](#) the diagram view as necessary.

Edit the name and description of a diagram view

You can edit the name and the description of a [diagram view](#).

Steps

1. Open a diagram view.
2. Click .
 - » The **Edit name and description** dialog box appears.

3. Enter the required information.

Field	Description
Name	Type a name for the diagram view. The default name is the name of the diagram view and a date stamp.
Description	Type a description for the diagram view.

4. Click **Save**.

Edit a diagram view

You can edit a [diagram view](#).

Steps

1. [Open](#) a diagram view.
2. Click .
- » The **General properties** form appears.
3. Edit the [general properties](#) as required.

Field	Description						
Layout	<p>Select the layout of your diagram view.</p> <table border="1" data-bbox="496 405 1415 1756"> <thead> <tr> <th data-bbox="496 405 699 539">Diagram layout</th> <th data-bbox="699 405 1415 539">Description</th> </tr> </thead> <tbody> <tr> <td data-bbox="496 539 699 1570"> Flow / Context </td> <td data-bbox="699 539 1415 1570"> <p>Nodes and edges are shown in a flow and a context region.</p> <p>In the flow region, nodes are shown mostly from left to right.</p> <p>The context region is shown above the flow region. The edges that begin or end with a node in the context region are shown with less emphasis (thinner and light gray). You can choose which nodes are in the context region by selecting the Context checkbox in the node properties form.</p> <p>If there are no nodes in the context region, this layout produces the same result as Hierarchy left -> right.</p> <div data-bbox="715 1328 1401 1552" style="background-color: #f0f0f0; padding: 10px; border: 1px solid #ccc;"> <p>Note For an edge between a flow node and a context node, the 'from' node must be in the flow region and the 'to' node in the context region.</p> </div> </td> </tr> <tr> <td data-bbox="496 1570 699 1756"> Hierarchy left - right </td> <td data-bbox="699 1570 1415 1756"> <p>Nodes and edges are shown in a flow, predominantly from left to right. This is the default layout.</p> </td> </tr> </tbody> </table>	Diagram layout	Description	Flow / Context	<p>Nodes and edges are shown in a flow and a context region.</p> <p>In the flow region, nodes are shown mostly from left to right.</p> <p>The context region is shown above the flow region. The edges that begin or end with a node in the context region are shown with less emphasis (thinner and light gray). You can choose which nodes are in the context region by selecting the Context checkbox in the node properties form.</p> <p>If there are no nodes in the context region, this layout produces the same result as Hierarchy left -> right.</p> <div data-bbox="715 1328 1401 1552" style="background-color: #f0f0f0; padding: 10px; border: 1px solid #ccc;"> <p>Note For an edge between a flow node and a context node, the 'from' node must be in the flow region and the 'to' node in the context region.</p> </div>	Hierarchy left - right	<p>Nodes and edges are shown in a flow, predominantly from left to right. This is the default layout.</p>
Diagram layout	Description						
Flow / Context	<p>Nodes and edges are shown in a flow and a context region.</p> <p>In the flow region, nodes are shown mostly from left to right.</p> <p>The context region is shown above the flow region. The edges that begin or end with a node in the context region are shown with less emphasis (thinner and light gray). You can choose which nodes are in the context region by selecting the Context checkbox in the node properties form.</p> <p>If there are no nodes in the context region, this layout produces the same result as Hierarchy left -> right.</p> <div data-bbox="715 1328 1401 1552" style="background-color: #f0f0f0; padding: 10px; border: 1px solid #ccc;"> <p>Note For an edge between a flow node and a context node, the 'from' node must be in the flow region and the 'to' node in the context region.</p> </div>						
Hierarchy left - right	<p>Nodes and edges are shown in a flow, predominantly from left to right. This is the default layout.</p>						

Field	Description	
	Diagram layout	Description
	Hierarchy top - down	Nodes and edges are shown in a flow, from top to bottom.
	Hierarchy bottom - up	Nodes and edges are shown in a flow, from bottom to top.
	Circular	<p>Nodes and edges are arranged in a circular fashion.</p> <p>Boxing nodes are not supported in this layout, therefore:</p> <ul style="list-style-type: none"> ◦ The diagram picture is completely redrawn. ◦ The explored nodes are removed from the diagram picture. ◦ The nodes expand or collapse to their initial state. ◦ Returning to a layout that supports boxing nodes completely redraws the diagram picture.
	Radial	<p>Nodes and edges are shown in a radial fashion, with no overlaps, few edge crossings and few bends.</p> <p>Boxing nodes are not supported in this layout. This has the same consequences as described for the Circular layout.</p>
	Smart Organic	Nodes and edges are distributed in a well-balanced manner, with few edge crossings.

Field	Description						
Traversal strategy	<p data-bbox="496 338 1326 421">Indicates which nodes and edges have to be traversed and displayed.</p> <table border="1" data-bbox="496 454 1417 1653"> <thead> <tr> <th data-bbox="496 454 743 589">Traversal strategy</th> <th data-bbox="743 454 1417 589">Description</th> </tr> </thead> <tbody> <tr> <td data-bbox="496 589 743 1395"> <p data-bbox="512 618 679 651">End-to-end</p> </td> <td data-bbox="743 589 1417 1395"> <p data-bbox="759 618 1393 891">For the start node, Collibra Data Governance Center traverses the relations of the types that occur in the diagram in all directions, incoming and outgoing, and adds all the nodes and edges that it encounters to the diagram.</p> <p data-bbox="759 931 1393 1294">For each encountered node, Collibra DGC traverses the relations only in the same direction as that in which they were encountered. If a node was encountered while traversing an outgoing relation, Collibra DGC looks for outgoing relations of that node and vice versa. This behavior is like traversing a hierarchy.</p> <p data-bbox="759 1335 1265 1368">This is the default traversal strategy.</p> </td> </tr> <tr> <td data-bbox="496 1395 743 1653"> <p data-bbox="512 1424 659 1458">Upstream</p> </td> <td data-bbox="743 1395 1417 1653"> <p data-bbox="759 1424 1366 1503">For the start node, only the incoming edges are traversed and shown.</p> <p data-bbox="759 1543 1275 1621">For each node encountered, only the incoming edges are traversed.</p> </td> </tr> </tbody> </table>	Traversal strategy	Description	<p data-bbox="512 618 679 651">End-to-end</p>	<p data-bbox="759 618 1393 891">For the start node, Collibra Data Governance Center traverses the relations of the types that occur in the diagram in all directions, incoming and outgoing, and adds all the nodes and edges that it encounters to the diagram.</p> <p data-bbox="759 931 1393 1294">For each encountered node, Collibra DGC traverses the relations only in the same direction as that in which they were encountered. If a node was encountered while traversing an outgoing relation, Collibra DGC looks for outgoing relations of that node and vice versa. This behavior is like traversing a hierarchy.</p> <p data-bbox="759 1335 1265 1368">This is the default traversal strategy.</p>	<p data-bbox="512 1424 659 1458">Upstream</p>	<p data-bbox="759 1424 1366 1503">For the start node, only the incoming edges are traversed and shown.</p> <p data-bbox="759 1543 1275 1621">For each node encountered, only the incoming edges are traversed.</p>
Traversal strategy	Description						
<p data-bbox="512 618 679 651">End-to-end</p>	<p data-bbox="759 618 1393 891">For the start node, Collibra Data Governance Center traverses the relations of the types that occur in the diagram in all directions, incoming and outgoing, and adds all the nodes and edges that it encounters to the diagram.</p> <p data-bbox="759 931 1393 1294">For each encountered node, Collibra DGC traverses the relations only in the same direction as that in which they were encountered. If a node was encountered while traversing an outgoing relation, Collibra DGC looks for outgoing relations of that node and vice versa. This behavior is like traversing a hierarchy.</p> <p data-bbox="759 1335 1265 1368">This is the default traversal strategy.</p>						
<p data-bbox="512 1424 659 1458">Upstream</p>	<p data-bbox="759 1424 1366 1503">For the start node, only the incoming edges are traversed and shown.</p> <p data-bbox="759 1543 1275 1621">For each node encountered, only the incoming edges are traversed.</p>						

Field	Description						
	<table border="1"> <thead> <tr> <th>Traversal strategy</th> <th>Description</th> </tr> </thead> <tbody> <tr> <td>Downstream</td> <td> <p>For the start node, only the outgoing edges are traversed and shown.</p> <p>For each node encountered, only the outgoing edges are traversed.</p> </td> </tr> <tr> <td>Complete</td> <td> <p>For the start node, the relations are traversed in both directions. All encountered nodes and edges are added to the diagram.</p> <p>For each encountered node, both incoming and outgoing edges are traversed. Essentially, this means that each encountered node is treated as a start node.</p> <div style="border-left: 2px solid red; padding-left: 10px; margin-top: 10px;"> <p>Warning This strategy can result in a very large diagram that can take a long time to load.</p> </div> </td> </tr> </tbody> </table>	Traversal strategy	Description	Downstream	<p>For the start node, only the outgoing edges are traversed and shown.</p> <p>For each node encountered, only the outgoing edges are traversed.</p>	Complete	<p>For the start node, the relations are traversed in both directions. All encountered nodes and edges are added to the diagram.</p> <p>For each encountered node, both incoming and outgoing edges are traversed. Essentially, this means that each encountered node is treated as a start node.</p> <div style="border-left: 2px solid red; padding-left: 10px; margin-top: 10px;"> <p>Warning This strategy can result in a very large diagram that can take a long time to load.</p> </div>
Traversal strategy	Description						
Downstream	<p>For the start node, only the outgoing edges are traversed and shown.</p> <p>For each node encountered, only the outgoing edges are traversed.</p>						
Complete	<p>For the start node, the relations are traversed in both directions. All encountered nodes and edges are added to the diagram.</p> <p>For each encountered node, both incoming and outgoing edges are traversed. Essentially, this means that each encountered node is treated as a start node.</p> <div style="border-left: 2px solid red; padding-left: 10px; margin-top: 10px;"> <p>Warning This strategy can result in a very large diagram that can take a long time to load.</p> </div>						
Overview	Select to show the overview inset in the initial diagram.						
Labels	Select to show the edge and node labels in the initial diagram.						
Legend	Select to show the legend in the initial diagram.						
Preview	Select to show the preview in the initial diagram.						

Field	Description
Max node label length	<p>Type the maximum number of characters for node labels. If a label is longer than this value, it is truncated.</p> <p>Type <i>0</i> if you always want to show the entire label.</p> <p>The default setting is <i>50</i>.</p>
Max edge label length	<p>Type the maximum number of characters for edge labels. If a label is longer than this value, it is truncated.</p> <p>Type <i>0</i> if you always want to show the entire label.</p> <p>The default setting is <i>30</i>.</p>

4. Select a node.
 - » The **Node properties** form appears.
5. Edit the [node properties](#) as required.

Field	Description
General	<p>This section allows you to edit the general properties of the selected node.</p> <div style="border-left: 2px solid green; padding-left: 10px; margin-top: 10px;"> <p>Tip Click it to collapse and expand this section.</p> </div>

Field	Description
Name	<p>Type a name for the selected node.</p> <div data-bbox="560 405 1417 624" style="border-left: 2px solid #008000; background-color: #f0f0f0; padding: 5px;"> <p>Tip By default, this is the name of the asset type or complex relation type. For readability, it is recommended to use the name of the asset type or complex relation type.</p> </div> <p>You can refer to this node by using its ID in the from and to fields of the edge properties form.</p> <p>This ID must be unique in the current diagram view.</p>
Type	<p>Choose an asset type.</p> <p>By default, this is the asset type of the selected node.</p>
Display name	<p>Choose the characteristic to use as the display name of the node in the diagram.</p> <p>If you leave this field empty, the node shows the name of the asset or the name of the complex relation. You can also choose a characteristic, for example, attribute or relation.</p> <p>The drop-down displays all the characteristics that apply.</p> <div data-bbox="560 1384 1417 1487" style="border-left: 2px solid #008000; background-color: #f0f0f0; padding: 5px;"> <p>Tip You can filter the list by starting to type.</p> </div>
Overlays	<p>Choose fields that you want to show on the node. For example, you can show characteristics, the status or the parent domain.</p> <p>The drop-down displays all the fields that you can show.</p> <div data-bbox="560 1765 1417 1868" style="border-left: 2px solid #008000; background-color: #f0f0f0; padding: 5px;"> <p>Tip You can filter the list by starting to type.</p> </div>

Field	Description
Context	<p>Select to place the node in the context region of the diagram.</p> <p>If not selected, the node is placed in the flow region.</p> <div data-bbox="560 477 1417 898" style="border: 1px solid #ccc; padding: 10px; margin-top: 10px;"> <p>Note This influences the traversal strategy: an edge from a flow node to a context node is always included in the diagram. This edge has to be outgoing from the flow node and incoming to the context node. This means that, when you switch a node from flow to context, you have to flip any edge that is outgoing from this context node and incoming to a flow node. For more information about the traversal strategy, see Which nodes and edges are included in a diagram?.</p> </div>
Boxing nodes options	<p>The options to determine how you want to show boxed nodes by default.</p> <div data-bbox="560 1059 1417 1240" style="border: 1px solid #ccc; padding: 10px; margin-top: 10px;"> <p>Tip The start node is always visible in the diagram, even when it is boxed inside of a collapsed or locked node.</p> </div>
Expanded	<p>Select to show boxing nodes and their boxed nodes.</p>
Collapsed	<p>Select to show boxing nodes, but not their boxed nodes. In the resulting diagram, you can expand these boxing nodes.</p>



Field	Description
Collapsed (hide boxed nodes)	<p>Select to show boxing nodes, but not their boxed nodes. In the resulting diagram, these nodes are locked, so you cannot expand them.</p> <div style="border: 1px solid #ccc; background-color: #f9f9f9; padding: 10px; margin-top: 10px;"> <p>Tip</p> <ul style="list-style-type: none"> ◦ Diagrams with locked nodes are also called summary diagrams. ◦ The boxed nodes of a locked node are not loaded when you open the diagram. As a consequence, opening the diagram may be a lot faster if some of the boxing nodes are locked. ◦ You can still explore locked nodes to see the boxed nodes. </div>
Edges	<p>This section allows you to add, edit and delete the edges.</p> <div style="border: 1px solid #ccc; background-color: #f9f9f9; padding: 10px; margin-top: 10px;"> <p>Tip Click it to collapse and expand this section.</p> </div>
Outgoing	
<outgoing edges>	The outgoing edges that currently exist.
Add	Click to add an outgoing edge.
Incoming	
<incoming edges>	The incoming edges that currently exist.
Add	Click to add an incoming edge.

Field	Description
Filters	<p>This section allows you to work with filters.</p> <div style="border: 1px solid #ccc; background-color: #f9f9f9; padding: 5px; margin-top: 10px;"> <p>Tip Click it to collapse and expand this section.</p> </div>
Filtering by business qualifier	<p>Enable users to filter diagrams by a chosen Business Qualifier asset.</p> <p>This feature is only available if it is enabled in Collibra Console.</p>
<existing filters>	The filter criteria that currently exist.
Add filter criteria	Click to create a filter.

6. Select an edge.
 - » The **Edge properties** form appears.
7. Edit the [edge properties](#) as required.

Field	Description
Relation type	<p>Select a relation type to define the relation type of the currently selected edge.</p> <p>The drop-down list shows all available directed relation types.</p>
Role direction	<p>Indicates the direction in which instances of this relation type are traversed.</p> <ul style="list-style-type: none"> ◦ Selected: The edge is traversed from head to tail. The edge label is the role of the relation type. ◦ Cleared: The edge is traversed from tail to head. The edge label is the co-role of the relation type.

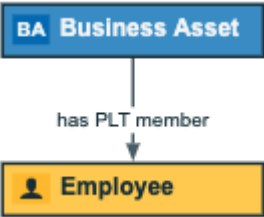
Field	Description
from	<p>Select the node from which the edge starts.</p> <p>In the drop-down list of nodes, the nodes that match the current type of edge are shown first (under Matching types). Nodes that do not match the current type are shown after the matching types (under All types). It is also indicated if the node is already in the diagram (on diagram).</p> <p>A matching node is (a parent of) the head asset type of the current relation type (when Role direction is selected) or (a parent of) the tail asset type of the relation type (when Role direction is cleared).</p> <p>Selecting a node that is already in the diagram view adds this edge to that node.</p> <p>Selecting a node that is not yet in the diagram view adds this node to the view.</p>
to	<p>Select the node in which the edge ends.</p> <p>You must select an ID from the drop-down list of nodes. The list contains nodes that match the current type of edge.</p> <p>A matching node is (a parent of) the tail asset type of the current relation type (when Role direction is selected) or (a parent of) the head asset type of the relation type (when Role direction is cleared).</p> <p>Selecting a node that is already in the diagram view adds this edge to that node.</p> <p>Selecting a node that is not yet in the diagram view adds this node to the view.</p>

Field	Description
Style	<p>Select the style of the edge.</p> <ul style="list-style-type: none"> <p>Arrow: An arrow from the outgoing side to the incoming side. The pointer is on the incoming side of the arrow. This is the default setting.</p> <p>Example Business Asset is the selected node.</p>  <p>Boxed: The node on the outgoing side is enclosed by the node on the incoming side.</p> <p>Example Business Asset is the selected node. It is boxed by Employee.</p>  <p>Boxing: The node on the outgoing side encloses the node on the incoming side.</p> <p>Example Business Asset is the selected node. It is boxing Employee.</p> 

Field	Description
Label	<p>Type a label for the edge.</p> <p>If you do not specify a label, either the role or co-role name of the relation type from the operating model is used in both the diagram view and the diagram.</p> <p>If the Role direction check box is selected, the label is the role of the relation. If it is cleared, it uses the co-role.</p>

8. Click **Save**.

The General properties form

The **General properties** form is used to define the overall look and feel of your [diagram](#).

This pane appears when you edit a [diagram view](#) and you have not selected a node or edge.

Field	Description										
Layout	<p>Select the layout of your diagram view.</p> <table border="1"> <thead> <tr> <th>Diagram layout</th> <th>Description</th> </tr> </thead> <tbody> <tr> <td>Flow / Context</td> <td> <p>Nodes and edges are shown in a flow and a context region.</p> <p>In the flow region, nodes are shown mostly from left to right.</p> <p>The context region is shown above the flow region. The edges that begin or end with a node in the context region are shown with less emphasis (thinner and light gray). You can choose which nodes are in the context region by selecting the Context checkbox in the node properties form.</p> <p>If there are no nodes in the context region, this layout produces the same result as Hierarchy left -> right.</p> <div style="background-color: #f0f0f0; padding: 10px; border: 1px solid #ccc;"> <p>Note For an edge between a flow node and a context node, the 'from' node must be in the flow region and the 'to' node in the context region.</p> </div> </td> </tr> <tr> <td>Hierarchy left - right</td> <td>Nodes and edges are shown in a flow, predominantly from left to right. This is the default layout.</td> </tr> <tr> <td>Hierarchy top - down</td> <td>Nodes and edges are shown in a flow, from top to bottom.</td> </tr> <tr> <td>Hierarchy bottom - up</td> <td>Nodes and edges are shown in a flow, from bottom to top.</td> </tr> </tbody> </table>	Diagram layout	Description	Flow / Context	<p>Nodes and edges are shown in a flow and a context region.</p> <p>In the flow region, nodes are shown mostly from left to right.</p> <p>The context region is shown above the flow region. The edges that begin or end with a node in the context region are shown with less emphasis (thinner and light gray). You can choose which nodes are in the context region by selecting the Context checkbox in the node properties form.</p> <p>If there are no nodes in the context region, this layout produces the same result as Hierarchy left -> right.</p> <div style="background-color: #f0f0f0; padding: 10px; border: 1px solid #ccc;"> <p>Note For an edge between a flow node and a context node, the 'from' node must be in the flow region and the 'to' node in the context region.</p> </div>	Hierarchy left - right	Nodes and edges are shown in a flow, predominantly from left to right. This is the default layout.	Hierarchy top - down	Nodes and edges are shown in a flow, from top to bottom.	Hierarchy bottom - up	Nodes and edges are shown in a flow, from bottom to top.
Diagram layout	Description										
Flow / Context	<p>Nodes and edges are shown in a flow and a context region.</p> <p>In the flow region, nodes are shown mostly from left to right.</p> <p>The context region is shown above the flow region. The edges that begin or end with a node in the context region are shown with less emphasis (thinner and light gray). You can choose which nodes are in the context region by selecting the Context checkbox in the node properties form.</p> <p>If there are no nodes in the context region, this layout produces the same result as Hierarchy left -> right.</p> <div style="background-color: #f0f0f0; padding: 10px; border: 1px solid #ccc;"> <p>Note For an edge between a flow node and a context node, the 'from' node must be in the flow region and the 'to' node in the context region.</p> </div>										
Hierarchy left - right	Nodes and edges are shown in a flow, predominantly from left to right. This is the default layout.										
Hierarchy top - down	Nodes and edges are shown in a flow, from top to bottom.										
Hierarchy bottom - up	Nodes and edges are shown in a flow, from bottom to top.										

Field	Description	
	Diagram layout	Description
	Circular	<p>Nodes and edges are arranged in a circular fashion.</p> <p>Boxing nodes are not supported in this layout, therefore:</p> <ul style="list-style-type: none"> • The diagraphpicture is completely redrawn. • The explored nodes are removed from the diagraphpicture. • The nodes expand or collapse to their initial state. • Returning to a layout that supports boxing nodes completely redraws the diagraphpicture.
	Radial	<p>Nodes and edges are shown in a radial fashion, with no overlaps, few edge crossings and few bends.</p> <p>Boxing nodes are not supported in this layout. This has the same consequences as described for the Circular layout.</p>
	Smart Organic	<p>Nodes and edges are distributed in a well-balanced manner, with few edge crossings.</p>

Field	Description								
Traversal strategy	Indicates which nodes and edges have to be traversed and displayed.								
	<table border="1"> <thead> <tr> <th data-bbox="427 405 679 539">Traversal strategy</th> <th data-bbox="679 405 1428 539">Description</th> </tr> </thead> <tbody> <tr> <td data-bbox="427 539 679 1249">End-to-end</td> <td data-bbox="679 539 1428 1249"> <p>For the start node, Collibra Data Governance Center traverses the relations of the types that occur in the diagram in all directions, incoming and outgoing, and adds all the nodes and edges that it encounters to the diagram.</p> <p>For each encountered node, Collibra DGC traverses the relations only in the same direction as that in which they were encountered. If a node was encountered while traversing an outgoing relation, Collibra DGC looks for outgoing relations of that node and vice versa. This behavior is like traversing a hierarchy.</p> <p>This is the default traversal strategy.</p> </td> </tr> <tr> <td data-bbox="427 1249 679 1503">Upstream</td> <td data-bbox="679 1249 1428 1503"> <p>For the start node, only the incoming edges are traversed and shown.</p> <p>For each node encountered, only the incoming edges are traversed.</p> </td> </tr> <tr> <td data-bbox="427 1503 679 1756">Downstream</td> <td data-bbox="679 1503 1428 1756"> <p>For the start node, only the outgoing edges are traversed and shown.</p> <p>For each node encountered, only the outgoing edges are traversed.</p> </td> </tr> </tbody> </table>	Traversal strategy	Description	End-to-end	<p>For the start node, Collibra Data Governance Center traverses the relations of the types that occur in the diagram in all directions, incoming and outgoing, and adds all the nodes and edges that it encounters to the diagram.</p> <p>For each encountered node, Collibra DGC traverses the relations only in the same direction as that in which they were encountered. If a node was encountered while traversing an outgoing relation, Collibra DGC looks for outgoing relations of that node and vice versa. This behavior is like traversing a hierarchy.</p> <p>This is the default traversal strategy.</p>	Upstream	<p>For the start node, only the incoming edges are traversed and shown.</p> <p>For each node encountered, only the incoming edges are traversed.</p>	Downstream	<p>For the start node, only the outgoing edges are traversed and shown.</p> <p>For each node encountered, only the outgoing edges are traversed.</p>
	Traversal strategy	Description							
	End-to-end	<p>For the start node, Collibra Data Governance Center traverses the relations of the types that occur in the diagram in all directions, incoming and outgoing, and adds all the nodes and edges that it encounters to the diagram.</p> <p>For each encountered node, Collibra DGC traverses the relations only in the same direction as that in which they were encountered. If a node was encountered while traversing an outgoing relation, Collibra DGC looks for outgoing relations of that node and vice versa. This behavior is like traversing a hierarchy.</p> <p>This is the default traversal strategy.</p>							
Upstream	<p>For the start node, only the incoming edges are traversed and shown.</p> <p>For each node encountered, only the incoming edges are traversed.</p>								
Downstream	<p>For the start node, only the outgoing edges are traversed and shown.</p> <p>For each node encountered, only the outgoing edges are traversed.</p>								
End-to-end	<p>For the start node, Collibra Data Governance Center traverses the relations of the types that occur in the diagram in all directions, incoming and outgoing, and adds all the nodes and edges that it encounters to the diagram.</p> <p>For each encountered node, Collibra DGC traverses the relations only in the same direction as that in which they were encountered. If a node was encountered while traversing an outgoing relation, Collibra DGC looks for outgoing relations of that node and vice versa. This behavior is like traversing a hierarchy.</p> <p>This is the default traversal strategy.</p>								
Upstream	<p>For the start node, only the incoming edges are traversed and shown.</p> <p>For each node encountered, only the incoming edges are traversed.</p>								
Downstream	<p>For the start node, only the outgoing edges are traversed and shown.</p> <p>For each node encountered, only the outgoing edges are traversed.</p>								

Field	Description				
	<table border="1"> <thead> <tr> <th>Traversal strategy</th> <th>Description</th> </tr> </thead> <tbody> <tr> <td>Complete</td> <td> <p>For the start node, the relations are traversed in both directions. All encountered nodes and edges are added to the diagram.</p> <p>For each encountered node, both incoming and outgoing edges are traversed. Essentially, this means that each encountered node is treated as a start node.</p> <div style="border-left: 2px solid red; padding-left: 10px; background-color: #f0f0f0;"> <p>Warning This strategy can result in a very large diagram that can take a long time to load.</p> </div> </td> </tr> </tbody> </table>	Traversal strategy	Description	Complete	<p>For the start node, the relations are traversed in both directions. All encountered nodes and edges are added to the diagram.</p> <p>For each encountered node, both incoming and outgoing edges are traversed. Essentially, this means that each encountered node is treated as a start node.</p> <div style="border-left: 2px solid red; padding-left: 10px; background-color: #f0f0f0;"> <p>Warning This strategy can result in a very large diagram that can take a long time to load.</p> </div>
Traversal strategy	Description				
Complete	<p>For the start node, the relations are traversed in both directions. All encountered nodes and edges are added to the diagram.</p> <p>For each encountered node, both incoming and outgoing edges are traversed. Essentially, this means that each encountered node is treated as a start node.</p> <div style="border-left: 2px solid red; padding-left: 10px; background-color: #f0f0f0;"> <p>Warning This strategy can result in a very large diagram that can take a long time to load.</p> </div>				
Overview	Select to show the overview inset in the initial diagram.				
Labels	Select to show the edge and node labels in the initial diagram.				
Legend	Select to show the legend in the initial diagram.				
Preview	Select to show the preview in the initial diagram.				
Max node label length	<p>Type the maximum number of characters for node labels. If a label is longer than this value, it is truncated.</p> <p>Type <i>0</i> if you always want to show the entire label.</p> <p>The default setting is <i>50</i>.</p>				

Field	Description
Max edge label length	<p>Type the maximum number of characters for edge labels. If a label is longer than this value, it is truncated.</p> <p>Type <i>0</i> if you always want to show the entire label.</p> <p>The default setting is <i>30</i>.</p>

The Node properties form

The **Node properties** form is used to define a node in the [diagram view](#) and the edges that are connected to it.

This pane appears when you edit a diagram view and you have selected a node.

Field	Description
General	<p>This section allows you to edit the general properties of the selected node.</p> <p>Tip Click it to collapse and expand this section.</p>
Name	<p>Type a name for the selected node.</p> <p>Tip By default, this is the name of the asset type or complex relation type. For readability, it is recommended to use the name of the asset type or complex relation type.</p> <p>You can refer to this node by using its ID in the from and to fields of the edge properties form.</p> <p>This ID must be unique in the current diagram view.</p>
Type	<p>Choose an asset type.</p> <p>By default, this is the asset type of the selected node.</p>

Field	Description
<p>Display name</p>	<p>Choose the characteristic to use as the display name of the node in the diagram.</p> <p>If you leave this field empty, the node shows the name of the asset or the name of the complex relation. You can also choose a characteristic, for example, attribute or relation.</p> <p>The drop-down displays all the characteristics that apply.</p> <p>Tip You can filter the list by starting to type.</p>
<p>Overlays</p>	<p>Choose fields that you want to show on the node. For example, you can show characteristics, the status or the parent domain.</p> <p>The drop-down displays all the fields that you can show.</p> <p>Tip You can filter the list by starting to type.</p>
<p>Context</p>	<p>Select to place the node in the context region of the diagram.</p> <p>If not selected, the node is placed in the flow region.</p> <p>Note This influences the traversal strategy: an edge from a flow node to a context node is always included in the diagram. This edge has to be outgoing from the flow node and incoming to the context node. This means that, when you switch a node from flow to context, you have to flip any edge that is outgoing from this context node and incoming to a flow node. For more information about the traversal strategy, see Which nodes and edges are included in a diagram?.</p>

Field	Description
Boxing nodes options	<p>The options to determine how you want to show boxed nodes by default.</p> <p>Tip The start node is always visible in the diagram, even when it is boxed inside of a collapsed or locked node.</p>
Expanded	Select to show boxing nodes and their boxed nodes.
Collapsed	Select to show boxing nodes, but not their boxed nodes. In the resulting diagram, you can expand these boxing nodes.
Collapsed (hide boxed nodes)	<p>Select to show boxing nodes, but not their boxed nodes. In the resulting diagram, these nodes are locked, so you cannot expand them.</p> <p>Tip</p> <ul style="list-style-type: none"> • Diagrams with locked nodes are also called summary diagrams. • The boxed nodes of a locked node are not loaded when you open the diagram. As a consequence, opening the diagram may be a lot faster if some of the boxing nodes are locked. • You can still explore locked nodes to see the boxed nodes.
Edges	<p>This section allows you to add, edit and delete the edges.</p> <p>Tip Click it to collapse and expand this section.</p>
Outgoing	
<outgoing edges>	The outgoing edges that currently exist.

Field	Description
Add	Click to add an outgoing edge.
Incoming	
<incoming edges>	The incoming edges that currently exist.
Add	Click to add an incoming edge.
Filters	<p>This section allows you to work with filters.</p> <div style="background-color: #f0f0f0; padding: 5px; border-left: 2px solid #008000;"> <p>Tip Click it to collapse and expand this section.</p> </div>
Filtering by business qualifier	<p>Enable users to filter diagrams by a chosen Business Qualifier asset.</p> <p>This feature is only available if it is enabled in Collibra Console.</p>
<existing filters>	The filter criteria that currently exist.
Add filter criteria	Click to create a filter.



The Edge properties form

The **Edge properties** form is used to define edges in the [diagram view](#).

This pane appears when you edit a [diagram view](#) and select an [edge](#).

Field	Description
Relation type	<p>Select a relation type to define the relation type of the currently selected edge.</p> <p>The drop-down list shows all available directed relation types.</p>
Role direction	<p>Indicates the direction in which instances of this relation type are traversed.</p> <ul style="list-style-type: none"> • Selected: The edge is traversed from head to tail. The edge label is the role of the relation type. • Cleared: The edge is traversed from tail to head. The edge label is the co-role of the relation type.
from	<p>Select the node from which the edge starts.</p> <p>In the drop-down list of nodes, the nodes that match the current type of edge are shown first (under Matching types). Nodes that do not match the current type are shown after the matching types (under All types). It is also indicated if the node is already in the diagram (on diagram).</p> <p>A matching node is (a parent of) the head asset type of the current relation type (when Role direction is selected) or (a parent of) the tail asset type of the relation type (when Role direction is cleared).</p> <p>Selecting a node that is already in the diagram view adds this edge to that node.</p> <p>Selecting a node that is not yet in the diagram view adds this node to the view.</p>

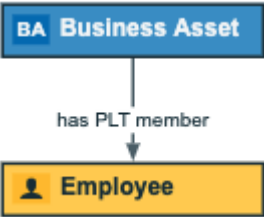
Field	Description
to	<p>Select the node in which the edge ends.</p> <p>You must select an ID from the drop-down list of nodes. The list contains nodes that match the current type of edge.</p> <p>A matching node is (a parent of) the tail asset type of the current relation type (when Role direction is selected) or (a parent of) the head asset type of the relation type (when Role direction is cleared).</p> <p>Selecting a node that is already in the diagram view adds this edge to that node.</p> <p>Selecting a node that is not yet in the diagram view adds this node to the view.</p>

Field	Description
Style	<p>Select the style of the edge.</p> <ul style="list-style-type: none"> Arrow: An arrow from the outgoing side to the incoming side. The pointer is on the incoming side of the arrow. This is the default setting. <p>Example Business Asset is the selected node.</p>  Boxed: The node on the outgoing side is enclosed by the node on the incoming side. <p>Example Business Asset is the selected node. It is boxed by Employee.</p>  Boxing: The node on the outgoing side encloses the node on the incoming side. <p>Example Business Asset is the selected node. It is boxing Employee.</p> 

Field	Description
Label	<p>Type a label for the edge.</p> <p>If you do not specify a label, either the role or co-role name of the relation type from the operating model is used in both the diagram view and the diagram.</p> <p>If the Role direction check box is selected, the label is the role of the relation. If it is cleared, it uses the co-role.</p>

Edges

In a diagram, an edge is a directed relation between two nodes. The word 'directed' indicates that the direction in which the relation is used is relevant for the diagram.

An edge is normally depicted by an arrow between two nodes. The arrow points to the 'to' node. It can also be represented by means of boxing and boxed nodes, in which one node contains the other.

Actions

- [Add](#) an edge to a node.
- [Edit](#) an edge.
- [Remove](#) an edge of a node.

Add an edge in a diagram view



You can add an [edge](#) to a node in a [diagram view](#).

Steps

1. [Open](#) a diagram view.
2. Click .
 - » The **General properties** form appears.
3. Select a node in the diagram.
 - » The **Node properties** form appears.

4. In the **Node properties** form, go to the **Edges** section.
5. Do one of the following:
 - Under **Outgoing**, click **Add**.
This adds an edge starting from the selected node.
 - Under **Incoming**, click **Add**.
This adds an edge ending in the selected node.
6. Define the edge characteristics:

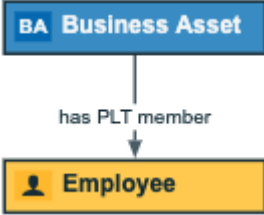
Edge characteristic	Description
Relation Type	Choose a relation type from the list of applicable types. Start typing to reduce the list.
Role direction	Choose in which direction to traverse a relation. For example, [Business asset] groups/is grouped by [Business Asset], if you select the Role direction option, you traverse in the role direction , meaning from parent to child. If you don't select this option, you traverse in the co-role direction, meaning from child to parent.
to	Choose the type of node (asset or complex relation) from the list of types. The dropdown first shows node types that match the relation type, but also allows you to choose a node whose type does not match the relation type. You can select a new node, or a node that already exists on the diagram.

Edge characteristic	Description
Style	<p>Select the style of the edge.</p> <ul style="list-style-type: none"> <p>Arrow: An arrow from the outgoing side to the incoming side. The pointer is on the incoming side of the arrow. This is the default setting.</p> <p>Example Business Asset is the selected node.</p>  <p>Boxed: The node on the outgoing side is enclosed by the node on the incoming side.</p> <p>Example Business Asset is the selected node. It is boxed by Employee.</p>  <p>Boxing: The node on the outgoing side encloses the node on the incoming side.</p> <p>Example Business Asset is the selected node. It is boxing Employee.</p> 

7. Click **Add**.

- Optionally, **edit** the edge.



Tip This allows you to edit the label of the edge.

- Above the diagram, to the right, click **Save**.

Edit an edge in a diagram view



You can edit an **edge** of a node in a **diagram view**.

Steps

- Open** a diagram view.
- Click .
 - » The **General properties** form appears.
- Do one of the following:
 - Select an edge in the diagram.
 - Select a node in the diagram and click  next to an incoming or outgoing edge in the edge section.
 - » The **Edge properties** form appears.
- Enter the required information.

Field	Description
Relation type	<p>Select a relation type to define the relation type of the currently selected edge.</p> <p>The drop-down list shows all available directed relation types.</p>
Role direction	<p>Indicates the direction in which instances of this relation type are traversed.</p> <ul style="list-style-type: none"> ◦ Selected: The edge is traversed from head to tail. The edge label is the role of the relation type. ◦ Cleared: The edge is traversed from tail to head. The edge label is the co-role of the relation type.

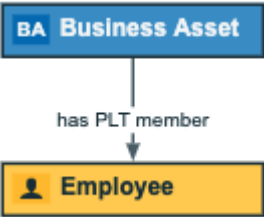
Field	Description
from	<p>Select the node from which the edge starts.</p> <p>In the drop-down list of nodes, the nodes that match the current type of edge are shown first (under Matching types). Nodes that do not match the current type are shown after the matching types (under All types). It is also indicated if the node is already in the diagram (on diagram).</p> <p>A matching node is (a parent of) the head asset type of the current relation type (when Role direction is selected) or (a parent of) the tail asset type of the relation type (when Role direction is cleared).</p> <p>Selecting a node that is already in the diagram view adds this edge to that node.</p> <p>Selecting a node that is not yet in the diagram view adds this node to the view.</p>
to	<p>Select the node in which the edge ends.</p> <p>You must select an ID from the drop-down list of nodes. The list contains nodes that match the current type of edge.</p> <p>A matching node is (a parent of) the tail asset type of the current relation type (when Role direction is selected) or (a parent of) the head asset type of the relation type (when Role direction is cleared).</p> <p>Selecting a node that is already in the diagram view adds this edge to that node.</p> <p>Selecting a node that is not yet in the diagram view adds this node to the view.</p>

Field	Description
Style	<p>Select the style of the edge.</p> <ul style="list-style-type: none"> <p>Arrow: An arrow from the outgoing side to the incoming side. The pointer is on the incoming side of the arrow. This is the default setting.</p> <p>Example Business Asset is the selected node.</p>  <p>Boxed: The node on the outgoing side is enclosed by the node on the incoming side.</p> <p>Example Business Asset is the selected node. It is boxed by Employee.</p>  <p>Boxing: The node on the outgoing side encloses the node on the incoming side.</p> <p>Example Business Asset is the selected node. It is boxing Employee.</p> 



Field	Description
Label	<p>Type a label for the edge.</p> <p>If you do not specify a label, either the role or co-role name of the relation type from the operating model is used in both the diagram view and the diagram.</p> <p>If the Role direction check box is selected, the label is the role of the relation. If it is cleared, it uses the co-role.</p>

- Above the diagram, to the right, click **Save**.

Remove an edge in a diagram view

You can remove an [edge](#) of a node in a [diagram view](#).

Steps

- [Open](#) a diagram view.
- Click .
 - » The **General properties** form appears.
- Select a node in the diagram.
 - » The **Node properties** form appears.
- Do one of the following:
 - Click  next to an incoming or outgoing edge in the edge section.
 - Select an edge in the diagram and click  in the upper right corner.
- Above the diagram, to the right, click **Save**.

Maximum flow depth

Big diagrams can have very long paths, or chains of [edges](#). They can take a long time to build, and are canceled if they exceed specified time and size limits for fetching data.

To help you control the size of diagrams, you can specify the maximum flow depth, meaning the flow relation path length from the start flow node set to any other flow node.

This aims to improve readability and performance, and reduce the potential for diagrams that are too big to build.

Terminology and details

Terminology	Description
Flow node	<p>A diagram node that matches a diagram view node that is not marked as context.</p> <p>This means that the "context" checkbox is not selected and, therefore, the node is situated in the flow region of the diagram.</p> <p>When the start node is a flow node, the start flow node set is only the start asset.</p>
Context node	<p>A diagram node that matches a diagram view node that is marked as context.</p> <p>This means that the "context" checkbox is selected and, therefore, the node is situated in the context region of the diagram.</p> <p>When the start node is a context node, the start flow node set is all assets and complex relations that are reachable from the start node by traversing only "flow-context" and "context-context" edges.</p>
Start flow node set	<p>The merge of all start node sets of each diagram view node that it matches.</p> <p>When the start node matches multiple diagram view nodes, the start flow node set is the merge of all start node sets of each view node that it matches.</p>
Flow depth	<p>The flow relation path length from the start flow node set to any other flow node.</p>
Flow edge	<p>An edge for which both nodes are flow nodes.</p>

Note Maximum flow depth is ignored when traversing edges that are not flow edges. "Flow-context" edges and "context-context" edges are ignored in order to maximize context, which reduces diagram size and improves readability.

Specifying the maximum flow depth

You do not have to enable this feature. You can, however, edit the system-wide maximum flow depth in Collibra Console. This establishes a maximum flow depth for all diagrams. The default value is 50.

You can also [specify](#) the maximum flow depth at the diagram view level. If you specify a value in a diagram view, that value supersedes the system-wide value in Collibra Console.

Adjusting flow depth in a diagram

We refer to a result diagram whose depth is limited by a specified maximum flow depth value as an "incomplete diagram". When an incomplete diagram is opened, a notification informs you that the diagram is incomplete. You can manually [adjust](#) the flow depth in the diagram, to view nodes that are hidden at greater depths.

Note When you open a diagram, the value shown in the [diagram toolbar](#) is the value that was set for the selected diagram view? If no value is set at the diagram view level, the value shown is the value that is set in Collibra Console.

Limitations

It bears mentioning that limiting flow depth does not prevent all diagrams from becoming too big to build. It can be that a single node has a large number of related assets, for example a Schema asset that contains 10,000 Table assets. In this case, the flow depth is only "1", but the diagram will "fan out" and might become too big to build.

Specify maximum flow depth

To help you control the size of business diagrams, you can specify the [maximum flow depth](#) in a diagram view.

There are two ways to do so:

- [Via the diagram editor](#)
- [Via the JSON text editor](#)

Tip You can also [adjust](#) the flow depth in a result diagram.

Note The value that you specify in the diagram view supersedes the value in Collibra Console. The default value in the Collibra Console configuration setting is 50.

Via the diagram editor

1. [Open](#) a diagram view.
2. In the View bar menu, click .
 - » The **General properties** form appears.
3. In the **Flow depth** field, enter a value between 0 and 99.
4. Click **Save**.

Via the JSON text editor

1. [Open](#) a diagram view.
2. In the View bar menu, click .
 - » The **General properties** form appears.
3. Click the **Text** tab, to switch to the diagram view text editor.

4. Scroll down and add `"flowDepth": x`, where "x" is the maximum flow depth.

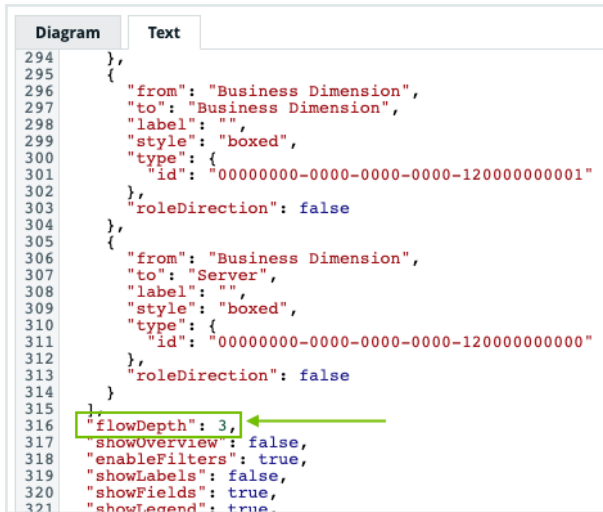

```

294 },
295 {
296   "from": "Business Dimension",
297   "to": "Business Dimension",
298   "label": "",
299   "style": "boxed",
300   "type": {
301     "id": "00000000-0000-0000-0000-120000000001"
302   },
303   "roleDirection": false
304 },
305 {
306   "from": "Business Dimension",
307   "to": "Server",
308   "label": "",
309   "style": "boxed",
310   "type": {
311     "id": "00000000-0000-0000-0000-120000000000"
312   },
313   "roleDirection": false
314 },
315 }
316 "flowDepth": 3,
317 "showOverview": false,
318 "enableFilters": true,
319 "showLabels": false,
320 "showFields": true,
321 "showLegend": true

```

5. Click **Save**.

Tip For more information on working with the diagram view text editor see:

- [JSON syntax: Nodes section](#)
- [Tips for creating correct diagram views with the JSON text editor](#)

Detailed description of JSON syntax for diagram views

A diagram view can be described by a file in a specific JavaScript Object Notation (JSON) format.

To design diagram views in JSON text format, it is important that you know the information in this section.

The examples of JSON code in the following sections are key-value pairs that you can use to [create a diagram view](#).

JSON syntax: Diagram section

These settings determine general display settings for the diagram.

JSON syntax	Description
<pre>"visitStrategy": "directed", "directedIncoming", "directedOutgoing", "completeGraph"</pre>	<ul style="list-style-type: none"> • Indicates which nodes and edges have to be traversed and displayed. • This setting is optional. • You can choose one of the following values: <ul style="list-style-type: none"> • <code>"directed"</code>: For the start node, Collibra DGC traverses the relations in all directions and adds all the nodes that it finds. For the encountered nodes, Collibra DGC traverses relations only in the same direction as how they are encountered: if a node was encountered by traversing an outgoing relation, Collibra DGC looks for outgoing relations, and vice versa. This behavior is similar to traversing a hierarchy. This is the default setting. <p>For a refinement to this strategy, see also the setting for <code>layoutRegion</code>.</p> • <code>"completeGraph"</code>: All nodes and edges related to the current asset are displayed, irrespective of the direction in which they were encountered. • <code>"directedIncoming"</code>: For the start node, Collibra DGC only traverses the incoming relations and adds all the nodes that it encounters. For the encountered nodes,

JSON syntax	Description
	<p>Collibra DGC traverses relations only in the same direction as how they are encountered: incoming relations only.</p> <ul style="list-style-type: none">• "directedOutgoing": For the start node, Collibra DGC only traverses the outgoing relations and adds all the nodes that it encounters. For the encountered nodes, Collibra DGC traverses relations only in the same direction as how they are encountered: outgoing relations only. <p>Be careful with using <code>completeGraph</code>, this setting can lead to very large diagrams.</p>

JSON syntax	Description
<pre data-bbox="177 338 810 465">"resultNodeUnicityStrategy": "multipleNodesPerAssetId", "singleNodePerAssetId"</pre>	<ul data-bbox="863 338 1417 1346" style="list-style-type: none"> • Indicates the number of times a node is displayed if it matches multiple nodes in the diagram view. • This setting is optional. • You can pick one of the following values: <ul style="list-style-type: none"> • <code>"multipleNodesPerAssetId"</code>: If an asset is encountered more than once for different nodes in the diagram view, it is represented by multiple nodes in the diagram, one per matching view node. This is the default setting. • <code>"singleNodePerAssetId"</code>: If an asset is encountered more than once for different nodes in the diagram view, it is represented by a single node in the diagram. <div data-bbox="855 1379 1417 1680" style="background-color: #f0f0f0; padding: 10px; margin-top: 10px;"> <p>Note If one asset is encountered multiple times for the same node in the diagram view, it is always displayed only once in the diagram. In that situation, there is a loop for that node.</p> </div>

JSON syntax	Description
<pre>"layout": "HierarchyLeftRight", "HierarchyTopBottom", "Hier- archyBottomTop", "Circular", "SmartOrganic", "Radial", "Flow/Context"</pre>	<ul style="list-style-type: none"> • Indicates the layout style of the diagram. • This setting is optional. • You can pick one of the following values: <ul style="list-style-type: none"> • "HierarchyLeftRight": Nodes and edges are displayed in a flow mostly from left to right. This is the default setting. • "HierarchyTopBottom": Nodes and edges are displayed in a flow mostly from top to bottom. • "HierarchyBottomTop": Nodes and edges are displayed in a flow mostly from bottom to top. • "Circular": Nodes and edges are arranged in a radial tree, where all nodes with the same number of edges to a given node are drawn in a circle. • "SmartOrganic": Nodes and edges are distributed in a well-balanced manner, there are minimal edge crossings. • "Radial": Nodes and edges are displayed with no overlaps, few edge crossings and few bends. • "Flow/Context": Layout style for diagrams with a flow and a context region. See also <code>layoutRegion</code> in the nodes section. Nodes and edges in the flow

JSON syntax	Description
	<p>region are displayed mostly from left to right. The nodes and edges in the context region are displayed above the flow region. An edge that begins or ends with a context node, is shown with less emphasis (thinner and in light gray) than an edge between two flow nodes. If you specify this layout, keep in mind that for an edge between a flow node and a context node, the from node has to be in the flow region and the to node has to be in the context region.</p>
<pre>"showOverview": false, true</pre>	<ul style="list-style-type: none"> • Indicates if the overview is displayed. • This setting is optional. • You can pick one of the following values: <ul style="list-style-type: none"> • <code>false</code>: The overview is not displayed. This is the default setting. • <code>true</code>: The overview is displayed.
<pre>"showLabels": false, true</pre>	<ul style="list-style-type: none"> • Indicates if the edge and node labels are displayed. • This setting is optional. • You can pick one of the following values: <ul style="list-style-type: none"> • <code>false</code>: The overlays are not displayed. This is the default setting. • <code>true</code>: The overlays are displayed.

JSON syntax	Description
<pre>"showLegend": false, true</pre>	<ul style="list-style-type: none"> • Indicates if the diagram legend is displayed. The legend shows all asset types and complex relation types that occur in the diagram. • This setting is optional. • You can pick one of the following values: <ul style="list-style-type: none"> • <code>false</code>: The legend is not displayed. • <code>true</code>: The legend is displayed. This is the default setting.
<pre>"showPreview": false, true</pre>	<ul style="list-style-type: none"> • Indicate if the preview pane is displayed by default. The preview pane shows information about the selected node or edge. • This setting is optional. • You can pick one of the following values: <ul style="list-style-type: none"> ◦ <code>false</code>: The legend is not displayed. ◦ <code>true</code>: The legend is displayed. This is the default setting.
<pre>"showFields": false, true</pre>	<ul style="list-style-type: none"> • Indicates if the overlays are displayed. • This setting is optional. • You can pick one of the following values: <ul style="list-style-type: none"> • <code>false</code>: The labels are not displayed. • <code>true</code>: The labels are displayed. This is the default setting.

JSON syntax	Description
<pre>"maxNodeLabelLength": 0, <positive integer number></pre>	<ul style="list-style-type: none"> • Indicates the maximum length of the node labels (whether they should be truncated when they are too long). • This setting is optional. • You can provide 0 or a positive integer number as the value: <ul style="list-style-type: none"> • 0: Node labels are not truncated, they are displayed in full length. • The default setting is 50.
<pre>"maxEdgeLabelLength": 0, <positive integer number></pre>	<ul style="list-style-type: none"> • Indicates the maximum length of the edge labels. Edge labels are truncated when they are longer. • This setting is optional. • You can provide 0 or a positive integer number as the value: <ul style="list-style-type: none"> • 0: Edge labels are not truncated, they are displayed in full length. • The default value is 30.
<pre>"edgeBundling": false, true</pre>	<ul style="list-style-type: none"> • Indicates whether edges of the same type are bundled to reduce clutter. • This setting is optional. • You can pick one of the following values: <ul style="list-style-type: none"> ◦ <code>false</code>: Edges are not bundled. ◦ <code>true</code>: Edges are bundled. This is the default setting.

JSON syntax	Description
<pre>"webworkersEnabled": false, true</pre>	<ul style="list-style-type: none"> • Indicates whether the layout-related calculations can be moved to a separate DGC service thread. This is useful for larger diagrams, so that your browser does not freeze while rendering the diagram. • This setting is optional. • You can pick one of the following values: <ul style="list-style-type: none"> ◦ <code>false</code>: Layout-related calculations are not moved to a separate DGC thread of your processor. ◦ <code>true</code>: For large diagrams, layout-related calculations are moved to a separate DGC thread of your processor. This is the default setting.

JSON syntax: Layout options

These options determine the layout of hierarchical diagrams.

- **Flow / Context**
- **Hierarchy left - right**
- **Hierarchy top - down**
- **Hierarchy bottom - up**

Example

```
"layoutOptions": {
  "compactGroups": false,
  "componentArrangementPolicy": "topmost",
  "edgeBends": true,
  "edgeBundling": true,
  "edgeToEdgeDistance": 5,
  "minimumLayerDistance": "auto",
  "nodeToEdgeDistance": 5,
  "orthogonalRouting": true,
  "preciseNodeHeightCalculation": true,
  "recursiveGroupLayering": true,
  "separateLayers": true,
  "webWorkers": true,
  "nodePlacer": {
    "barycenterMode": "auto",
    "breakLongSegments": "auto",
    "groupCompactionStrategy": "none",
    "nodeCompaction": "auto",
    "straightenEdges": "auto"
  }
}
```

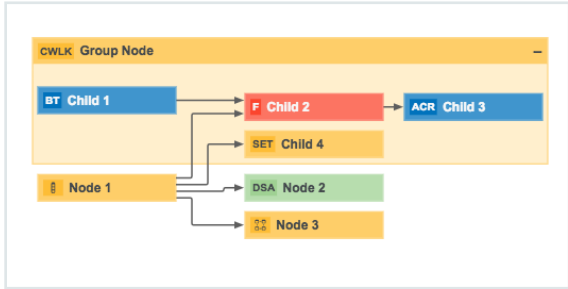
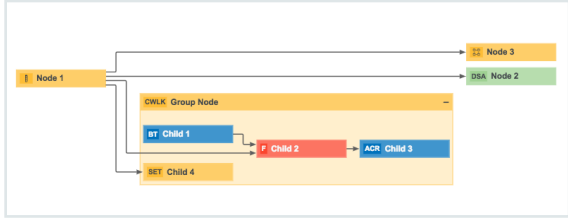
JSON syntax with all default values	Description
<pre data-bbox="177 338 735 371">"compactGroups": true // false</pre>	<p data-bbox="807 338 1398 465">Group compaction reduces the number of node layers without reversing edge directions.</p> <p data-bbox="807 506 1406 633">The resulting layering tries to keep the layer span of a boxing node at a minimum, while minimizing the overall vertical space.</p> <p data-bbox="807 674 1315 752">You can choose one of the following values:</p> <ul data-bbox="815 792 1406 965" style="list-style-type: none"> • <code>true</code>: The diagram view uses as few node layers as possible. The layers of a diagram are also used inside a boxing node. <p data-bbox="847 983 975 1016">Example</p>  <p data-bbox="815 1337 1417 1509">• <code>false</code>: The diagram view does not try to reduce the number of node layers. This results in separate layers inside a boxing node.</p> <p data-bbox="847 1527 975 1561">Example</p> 

JSON syntax with all default values	Description
	<p data-bbox="858 367 932 398">Note</p> <ul data-bbox="868 405 1342 712" style="list-style-type: none"><li data-bbox="868 405 1342 562">• This option is only applicable when <code>recursiveGroupLayering</code> is set to <code>true</code>.<li data-bbox="868 568 1219 600">• This option is optional.<li data-bbox="868 607 1283 638">• The default value is <code>false</code>.<li data-bbox="868 645 1326 712">• This option does not affect the loading time of the diagram.

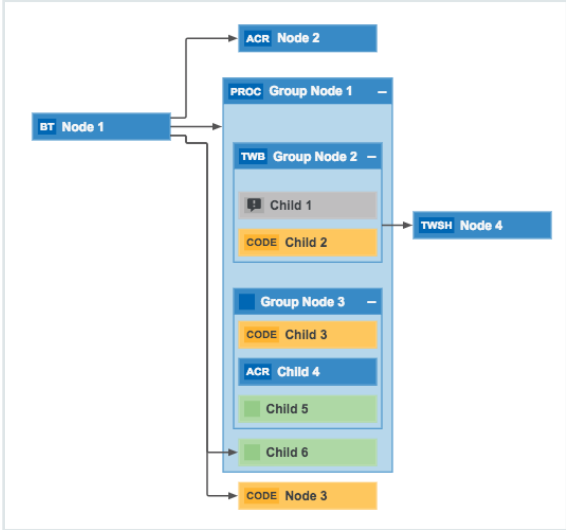
JSON syntax with all default values	Description
<pre> "componentArrangementPolicy": "topmost" // "compact" </pre>	<p>Choose how to arrange boxed nodes that are not connected by the arrow edge with other nodes.</p> <p>This is only applicable to boxed and boxing edges.</p> <p>You can choose one of the following values:</p> <ul style="list-style-type: none"> • <code>"topmost"</code>: Vertically align the boxed nodes with their topmost boxed node inside the boxing node. • Example  <ul style="list-style-type: none"> • <code>"compact"</code>: Put the boxed nodes in different layers to reduce the size of the boxing node. This reduces the overall diagram size. <p>If the diagram layout is Hierarchy left - right or Flow / Context, the height of the diagram will be minimized.</p> <p>If the diagram layout is Hierarchy bottom - up or Hierarchy top - down, the</p>

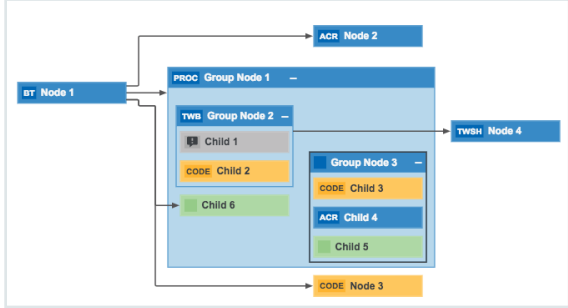
JSON syntax with all default values	Description
	<p>width will be minimized.</p> <ul style="list-style-type: none"> • Example  <p>Note</p> <ul style="list-style-type: none"> • This option is optional. • The default value is <code>topmost</code>. • This option does not affect the loading time of the diagram.

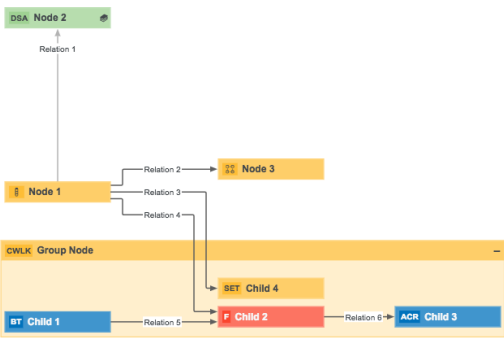
JSON syntax with all default values	Description
<pre data-bbox="177 338 660 371">"edgeBends": true // false</pre>	<p data-bbox="805 338 1406 421">Choose whether edges can be curved and can contain bends.</p> <div data-bbox="805 450 1417 674" style="border-left: 2px solid red; padding-left: 10px; background-color: #f0f0f0;"> <p data-bbox="855 488 1356 640">Warning When this option is false, the <code>edgeBundling</code> and <code>orthogonalRouting</code> options are automatically ignored.</p> </div> <p data-bbox="805 712 1318 795">You can choose one of the following values:</p> <ul data-bbox="815 831 1238 869" style="list-style-type: none"> • <code>true</code>: Enables edge bends. <p data-bbox="845 880 975 913">Example</p> <div data-bbox="847 920 1417 1317" style="border: 1px solid #ccc; padding: 10px;">  <pre data-bbox="887 958 1393 1294"> graph TD Node1[Node 1] -- Relation 1 --> Node2[Node 2] Node1 -- Relation 2 --> Node3[Node 3] Node1 -- Relation 3 --> CWLK[CWLK Group Node] Node1 -- Relation 4 --> Child4[SET Child 4] CWLK -- Relation 5 --> Child1[BT Child 1] CWLK -- Relation 6 --> Child2[F Child 2] CWLK -- Relation 6 --> Child3[ACR Child 3] Node3 -- Relation 4 --> Child4 </pre> </div> <ul data-bbox="815 1346 1265 1473" style="list-style-type: none"> • <code>false</code>: Disables edge bends, <code>edgeBundling</code> and <code>orthogonalRouting</code>. <p data-bbox="845 1485 1422 1664">Edges without bends go in a straight line from source node to target node, and may cross other nodes. They don't reserve space for edge labels.</p> <p data-bbox="845 1675 975 1709">Example</p>

JSON syntax with all default values

Description

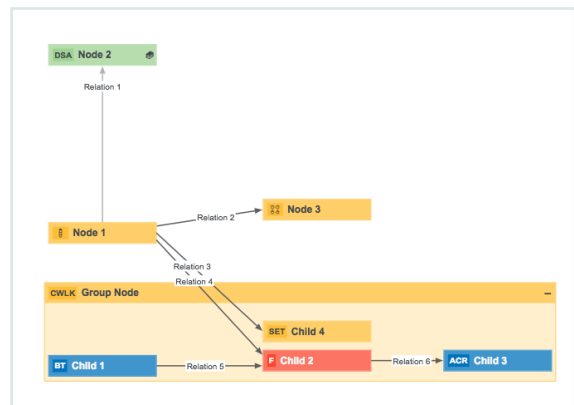

Note

- This option is optional.
- The default value is `true`.
- Choosing `true` may lead to an increased loading time of the diagram.

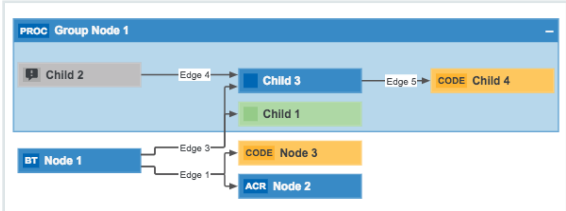
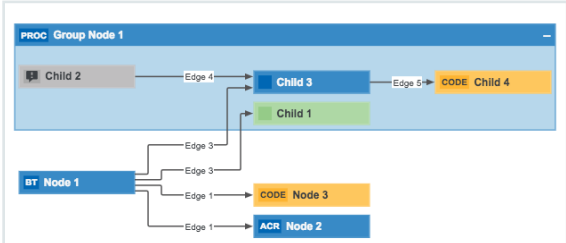
JSON syntax with all default values	Description
<pre>"edgeBundling": true // false</pre>	<p>Choose whether arrow edges can be bundled at the source or target node when they represent the same incoming or outgoing relation.</p> <div data-bbox="810 548 1417 689" style="border: 1px solid #ccc; padding: 10px; background-color: #f9f9f9;"> <p>Note Only one edge label is displayed for a bundled edge.</p> </div> <p>You can choose one of the following values:</p> <ul style="list-style-type: none"> <code>true</code>: Enable edge bundling. <p>Example</p>  <ul style="list-style-type: none"> <code>false</code>: Disable edge bundling. <p>Example</p>  <div data-bbox="810 1554 1417 1845" style="border: 1px solid #ccc; padding: 10px; background-color: #f9f9f9;"> <p>Note</p> <ul style="list-style-type: none"> This option is optional. The default value is <code>true</code>. Choosing <code>true</code> may lead to an increased loading time of the diagram. </div>

JSON syntax with all default values	Description
<pre>"edgeToEdgeDistance": 5 // "auto"</pre>	<p>Set the minimum distance (in pixels) between two adjacent edges in one layer.</p> <p>This affects the horizontal distance if the diagram layout is:</p> <ul style="list-style-type: none"> • Hierarchy left - right • Flow / Context, but only for nodes in the flow <p>This affects the vertical distance if the diagram layout is:</p> <ul style="list-style-type: none"> • Hierarchy top - down • Hierarchy bottom - up • Flow / Context, but only for nodes in the context <p>You can choose one of the following values:</p> <ul style="list-style-type: none"> • [Any positive integer value]: Use this amount of pixels. • "auto": Let a layouting algorithm automatically set the value. <div data-bbox="810 1402 1417 1653" style="background-color: #f0f0f0; padding: 10px;"> <p>Note</p> <ul style="list-style-type: none"> • This option is optional. • The default value is 5. • This option does not affect the loading time of the diagram. </div>

JSON syntax with all default values	Description
<pre>"minimumLayerDistance": 5 // "auto"</pre>	<p>Set the minimum distance (in pixels) between two adjacent layers.</p> <p>This affects the horizontal distance if the diagram layout is:</p> <ul style="list-style-type: none"> • Hierarchy left - right • Flow / Context, but only for nodes in the flow <p>This affects the vertical distance if the diagram layout is:</p> <ul style="list-style-type: none"> • Hierarchy top - down • Hierarchy bottom - up • Flow / Context, but only for nodes in the context <p>You can choose one of the following values:</p> <ul style="list-style-type: none"> • [Any positive integer value]: Use this amount of pixels. • "auto": Let a layouting algorithm automatically set the value. <div data-bbox="810 1402 1417 1659" style="background-color: #f0f0f0; padding: 10px;"> <p>Note</p> <ul style="list-style-type: none"> • This option is optional. • The default value is <code>auto</code>. • This option does not affect the loading time of the diagram. </div>

JSON syntax with all default values	Description
<pre>"nodeToEdgeDistance": 5 // "auto"</pre>	<p>Set the minimum distance (in pixels) between an edge and an adjacent node in the same layer.</p> <p>This affects the horizontal distance if the diagram layout is:</p> <ul style="list-style-type: none"> • Hierarchy left - right • Flow / Context, but only for nodes in the flow <p>This affects the vertical distance if the diagram layout is:</p> <ul style="list-style-type: none"> • Hierarchy top - down • Hierarchy bottom - up • Flow / Context, but only for nodes in the context <p>You can choose one of the following values:</p> <ul style="list-style-type: none"> • [Any positive integer value]: Use this amount of pixels. • "auto": Let a layouting algorithm automatically set the value. <div data-bbox="810 1451 1417 1704" style="background-color: #f0f0f0; padding: 10px;"> <p>Note</p> <ul style="list-style-type: none"> • This option is optional. • The default value is 5. • This option does not affect the loading time of the diagram. </div>

JSON syntax with all default values

```
"orthogonalRouting": true //
false
```

Description

Choose whether or not edges can be routed orthogonally.

You can choose one of the following values:

- `true`: All edge segments are horizontal or vertical.

Example

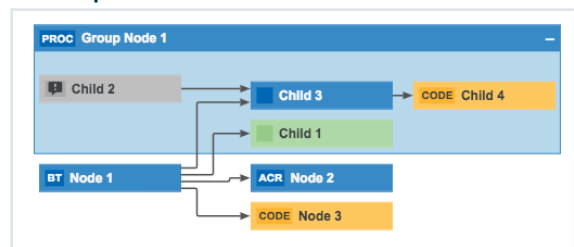

- `false`: Edge segments can be diagonal.

Example

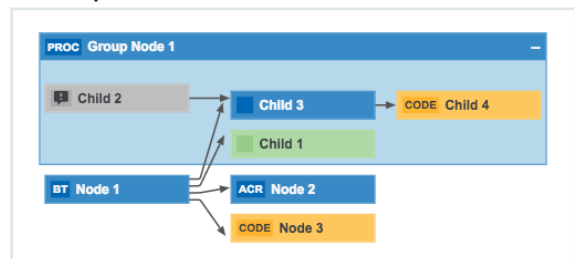

Note

- This option is optional.
- The default value is `true`.
- This option does not affect the loading time of the diagram.

JSON syntax with all default values	Description
<pre>"preciseNodeHeightCalculation": true // false</pre>	<p data-bbox="807 338 1401 472">Determines the precision with which node heights are rendered to visually accommodate diagram text.</p> <ul data-bbox="815 506 1406 969" style="list-style-type: none"><li data-bbox="815 506 1406 685">• <code>true</code>: Each node is correctly sized to fit its label text. For extremely large diagrams, this can result in significantly longer loading times.<li data-bbox="815 696 1406 969">• <code>false</code>: Loading times are vastly improved, but label text might not always fit in the nodes. When label text doesn't fit, the text is truncated by an ellipsis. For example: "ABC_Finance_Freq...". <div data-bbox="810 1003 1417 1294" style="background-color: #f0f0f0; padding: 10px;"><p data-bbox="858 1037 930 1066">Note</p><ul data-bbox="866 1077 1334 1263" style="list-style-type: none"><li data-bbox="866 1077 1334 1106">• This option is optional.<li data-bbox="866 1117 1334 1146">• The default value is <code>true</code>.<li data-bbox="866 1158 1334 1263">• Choosing <code>true</code> may lead to an increased loading time of the diagram.</div>

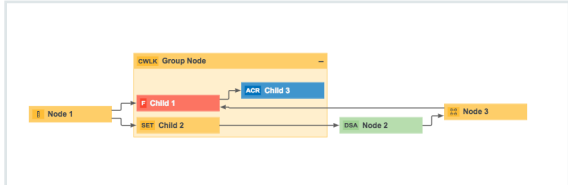
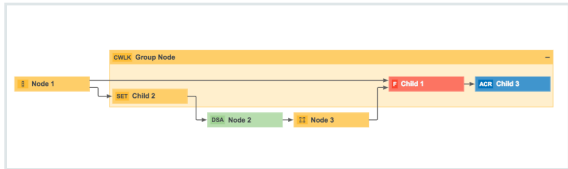
JSON syntax with all default values	Description
<pre data-bbox="177 338 735 421">"recursiveGroupLayering": true // false</pre>	<p data-bbox="807 338 1294 421">Choose whether boxing edges are respected during layering.</p> <p data-bbox="807 459 1374 542">This option is ignored when the diagram does not contain boxing nodes.</p> <div data-bbox="807 573 1417 875" style="border: 1px solid red; padding: 5px; margin: 10px 0;"> <p data-bbox="858 607 1366 842">Warning Enabling this option may change the diagram flow. Some arrow edges may go in the opposite direction. Otherwise occupying only adjacent layers by boxing nodes wouldn't be possible in some cases.</p> </div> <p data-bbox="807 911 1318 994">You can choose one of the following values:</p> <ul data-bbox="815 1032 1410 1211" style="list-style-type: none"> <li data-bbox="815 1032 1410 1211">• <code>true</code>: Boxing nodes are layered recursively: Boxed nodes in the same boxing node always occupy adjacent layers. <p data-bbox="847 1223 975 1261">Example</p> <div data-bbox="847 1263 1417 1447">  </div> <ul data-bbox="815 1473 1426 1556" style="list-style-type: none"> <li data-bbox="815 1473 1426 1556">• <code>false</code>: Group information is ignored during the layering. <p data-bbox="847 1568 975 1606">Example</p> <div data-bbox="847 1608 1417 1776">  </div>

JSON syntax with all default values	Description
	<p data-bbox="858 367 932 398">Note</p> <ul data-bbox="868 407 1334 595" style="list-style-type: none"><li data-bbox="868 407 1214 439">• This option is optional.<li data-bbox="868 443 1262 474">• The default value is <code>true</code>.<li data-bbox="868 479 1334 595">• Choosing <code>true</code> may lead to an increased loading time of the diagram.

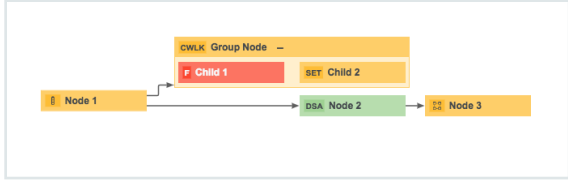
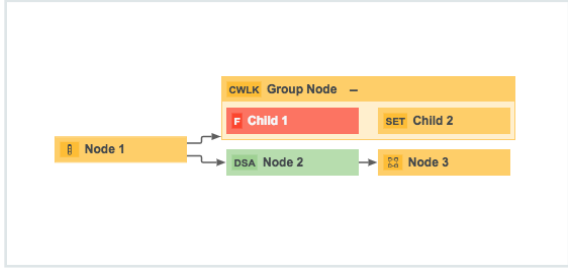
JSON syntax with all default values	Description
<pre data-bbox="177 338 751 371">"separateLayers": true // false</pre>	<p data-bbox="809 338 1394 517">Strictly separate nodes of different layers. In other words, nodes are placed below each other. This prevents big nodes from extending into an adjacent layer.</p> <p data-bbox="809 555 1318 633">You can choose one of the following values:</p> <ul data-bbox="817 674 1249 707" style="list-style-type: none"> • <code>true</code>: Layers are separated. <p data-bbox="847 723 975 757">Example</p>  <ul data-bbox="817 969 1318 1003" style="list-style-type: none"> • <code>false</code>: Layers are not separated. <p data-bbox="847 1014 975 1048">Example</p>  <div data-bbox="847 1395 1417 1592" style="background-color: #f0f0f0; padding: 10px;"> <p data-bbox="858 1402 930 1435">Note</p> <ul data-bbox="866 1440 1326 1585" style="list-style-type: none"> • This option is optional. • The default value is <code>true</code>. • This option does not affect the loading time of the diagram. </div>

JSON syntax with all default values	Description
<pre>"webWorkers": true // false</pre>	<p>Choose whether big diagrams should be built in the background thread.</p> <p>You can choose one of the following values:</p> <ul style="list-style-type: none"> • <code>true</code>: Enables multi-thread support for diagram building. <div data-bbox="847 667 1417 846" style="background-color: #f0f0f0; padding: 5px;"> <p>Note This makes layout processing faster and less likely to freeze the browser.</p> </div> <ul style="list-style-type: none"> • <code>false</code>: All diagrams are built in the main thread. <div data-bbox="810 999 1417 1294" style="background-color: #f0f0f0; padding: 5px;"> <p>Note</p> <ul style="list-style-type: none"> • This option is optional. • The default value is <code>true</code>. • Choosing <code>false</code> may lead to an increased loading time of the diagram. </div>
<pre>"nodeplacer"</pre>	<p>Use additional options for placing the nodes.</p>

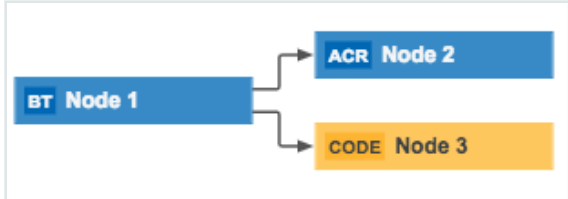
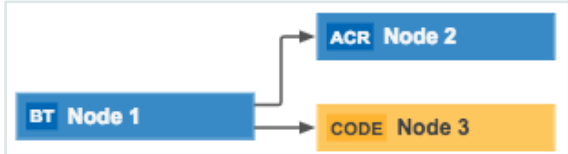
JSON syntax with all default values	Description
<pre data-bbox="301 344 762 427">"barycenterMode": true // false // "auto"</pre>	<p data-bbox="807 338 1406 472">Choose whether the diagram should be as symmetric as possible. This may result in more edge bends.</p> <p data-bbox="807 506 1318 589">You can choose one of the following values:</p> <ul data-bbox="815 627 1386 710" style="list-style-type: none"> • <code>true</code>: The diagram is more symmetric but may have more edge bends. <p data-bbox="847 721 975 757">Example</p>  <ul data-bbox="815 987 1390 1070" style="list-style-type: none"> • <code>false</code>: The diagram is less symmetric but may have fewer edge bends. <p data-bbox="847 1081 975 1117">Example</p>  <ul data-bbox="815 1303 1386 1480" style="list-style-type: none"> • <code>"auto"</code>: The layouting algorithm decides whether this option is set to <code>true</code> or <code>false</code>, depending on the diagram data. <div data-bbox="810 1512 1417 1809" style="background-color: #f0f0f0; padding: 10px;"> <p data-bbox="858 1547 930 1576">Note</p> <ul data-bbox="866 1585 1334 1771" style="list-style-type: none"> • This option is optional. • The default value is <code>auto</code>. • Choosing <code>true</code> may lead to an increased loading time of the diagram. </div>

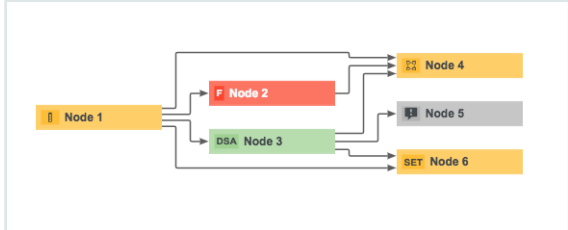
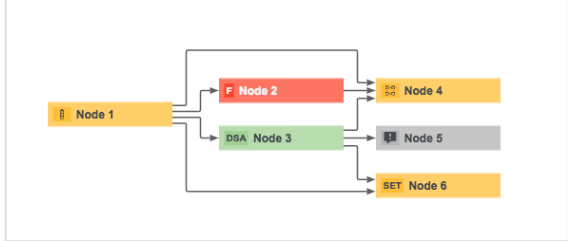
JSON syntax with all default values	Description
<pre data-bbox="300 344 766 425">"breakLongSegments": true // false // "auto"</pre>	<p data-bbox="807 338 1414 472">Choose whether the diagram should break long arrow edges in favor of a more compact layout.</p> <p data-bbox="807 506 1318 586">You can choose one of the following values:</p> <ul data-bbox="815 627 1347 707" style="list-style-type: none"> • <code>true</code>: Long edges are broken, for a more compact diagram. <p data-bbox="847 721 975 757">Example</p>  <ul data-bbox="815 1021 1347 1057" style="list-style-type: none"> • <code>false</code>: Long edges are not broken. <p data-bbox="847 1068 975 1104">Example</p>  <ul data-bbox="815 1379 1385 1554" style="list-style-type: none"> • <code>"auto"</code>: The layouting algorithm decides whether this option is set to <code>true</code> or <code>false</code>, depending on the diagram data. <div data-bbox="815 1585 1417 1881" style="background-color: #f0f0f0; padding: 10px;"> <p data-bbox="858 1621 930 1653">Note</p> <ul data-bbox="866 1659 1334 1848" style="list-style-type: none"> • This option is optional. • The default value is <code>auto</code>. • Choosing <code>true</code> may lead to an increased loading time of the diagram. </div>

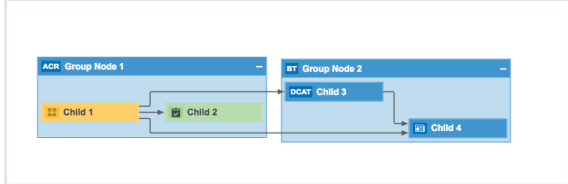
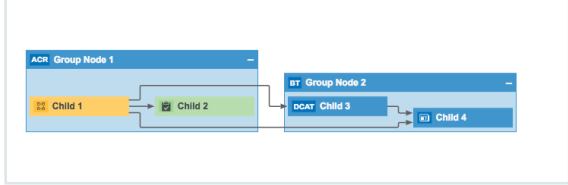
JSON syntax with all default values	Description
<pre data-bbox="288 344 767 427">"groupCompactionStrategy": "none" // "maximum"</pre>	<p data-bbox="807 338 1385 421">Choose the strategy for controlling the horizontal compactness of boxing nodes.</p> <p data-bbox="807 459 1318 542">You can choose one of the following values:</p> <ul data-bbox="815 580 1410 801" style="list-style-type: none"> • <code>"none"</code>: Do not use horizontal group compaction. The contents of a boxing node will occupy nearly the same horizontal positions as when not grouped at all. <p data-bbox="847 817 975 853">Example</p>  <ul data-bbox="815 1070 1410 1153" style="list-style-type: none"> • <code>"maximum"</code>: Make boxing nodes as narrow as possible. <p data-bbox="847 1169 975 1205">Example</p>  <div data-bbox="847 1435 1417 1740" style="background-color: #f0f0f0; padding: 10px;"> <p data-bbox="858 1473 932 1509">Note</p> <ul data-bbox="866 1514 1334 1700" style="list-style-type: none"> • This option is optional. • The default value is <code>none</code>. • Choosing <code>none</code> may lead to an increased loading time of the diagram. </div>

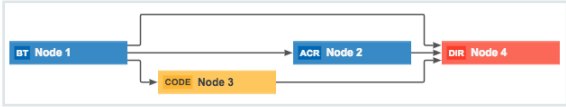
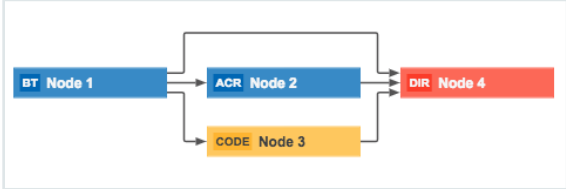
JSON syntax with all default values	Description
<pre data-bbox="300 344 762 425">"nodeCompaction": true // false // "auto"</pre>	<p data-bbox="807 338 1415 566">Choose whether to reduce the height of the diagram as much as possible. This places the nodes of a layer in a stacked style (horizontally interleaving), which reduces the width of the layer.</p> <p data-bbox="807 602 1318 683">You can choose one of the following values:</p> <ul data-bbox="815 721 1378 804" style="list-style-type: none"> • <code>true</code>: Nodes are placed in a compact style. <div data-bbox="849 810 1417 954" style="background-color: #f0f0f0; padding: 10px; border: 1px solid #ccc;"> <p data-bbox="898 844 1283 918">Note This may result in an increased width.</p> </div> <p data-bbox="847 990 975 1025">Example</p>  <ul data-bbox="815 1162 1398 1245" style="list-style-type: none"> • <code>false</code>: Nodes are not placed in a compact style. <p data-bbox="847 1256 975 1292">Example</p>  <ul data-bbox="815 1512 1383 1688" style="list-style-type: none"> • <code>"auto"</code>: The layouting algorithm decides whether this option is set to <code>true</code> or <code>false</code>, depending on the diagram data.

JSON syntax with all default values	Description
	<p data-bbox="858 367 932 398">Note</p> <ul data-bbox="868 407 1326 555" style="list-style-type: none"><li data-bbox="868 407 1214 439">• This option is optional.<li data-bbox="868 443 1262 474">• The default value is <code>auto</code>.<li data-bbox="868 479 1326 555">• This option does not affect the loading time of the diagram.

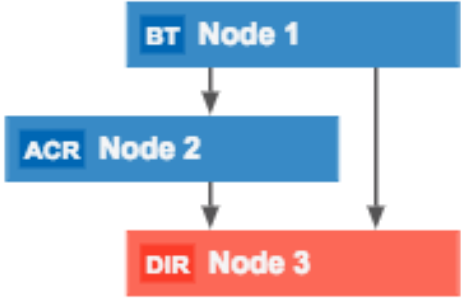
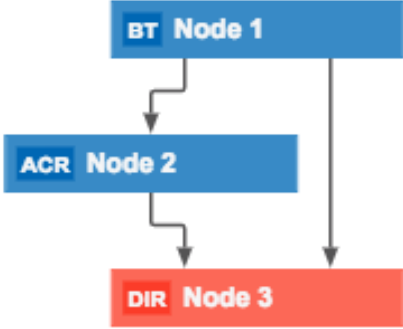
JSON syntax with all default values	Description
<pre data-bbox="300 344 730 427">"straightenEdges": true // false // "auto"</pre>	<p data-bbox="809 338 1358 421">Apply a post-processing step to reduce edge bends.</p> <p data-bbox="809 459 1318 542">You can choose one of the following values:</p> <ul data-bbox="817 580 1331 663" style="list-style-type: none"> • <code>true</code>: The post-processing step is applied to reduce edge bends. <p data-bbox="847 674 975 710">Example</p> <div data-bbox="850 719 1418 1077">  <pre data-bbox="884 745 1347 1043"> graph TD BT[BT Node 1] --> ACR[ACR Node 2] BT --> DIR[DIR Node 3] ACR --> DIR </pre> </div> <div data-bbox="850 1095 1418 1317" style="border: 1px solid red; padding: 5px;"> <p data-bbox="898 1128 1374 1283">Warning This may violate some minimum distances specified by the user and the edge distribution may no longer be uniform.</p> </div> <ul data-bbox="817 1355 1342 1438" style="list-style-type: none"> • <code>false</code>: Post-processing step is not applied. <p data-bbox="847 1449 975 1485">Example</p> <div data-bbox="850 1494 1418 1897">  <pre data-bbox="911 1532 1315 1859"> graph TD BT[BT Node 1] --> ACR[ACR Node 2] BT --> DIR[DIR Node 3] ACR --> DIR </pre> </div>

JSON syntax with all default values	Description
	<ul style="list-style-type: none"> • <code>"auto"</code>: The layouting algorithm decides whether this option is set to <code>true</code> or <code>false</code>, depending on the diagram data. <div style="background-color: #f0f0f0; padding: 10px; margin-top: 10px;"> <p>Note</p> <ul style="list-style-type: none"> • This option is optional. • The default value is <code>auto</code>. • Choosing <code>true</code> may lead to an increased loading time of the diagram. </div>

JSON syntax: Nodes section

These settings determine the display settings for nodes. You must add a node for each asset type and complex relation type that you want to include in the diagram.

Note The JSON representation of a diagram is always automatically generated. The JSON syntax allows you to update the diagram layout. Keep in mind that it is much easier to add and edit overlays through the graphical diagram view editor. See [Edit a diagram view](#) and [The Node properties form](#).

JSON syntax	Description
<code>"id": "Business Asset"</code>	<ul style="list-style-type: none"> • Determines the name of the node. • This setting is mandatory. • You can type any string here, but it must be unique in this view. For readability, we recommend using the name of the asset type or complex relation type as the ID. • You can refer to this node by using its ID in the <code>"from"</code> and <code>"to"</code> key-value pairs of the edges section.

JSON syntax	Description
<pre>"type": {"id": "00000000-0000-0000-0000-000000011001"}</pre>	<ul style="list-style-type: none"> • Determines the resource ID of the asset type or the complex relation type. • This setting is mandatory. • You can have multiple nodes with the same <code>Type</code> in one diagram view. • The value must be a valid resource ID of an asset type or complex relation type. See Find a resource ID of an asset type and Find the resource ID of a complex relation.
<pre>"layoutRegion": "flow", "context"</pre>	<ul style="list-style-type: none"> • Determine if the node is treated as a flow node or a context node. This influences the traversal strategy. An edge from a flow node to a context node is always included in the diagram. An edge between two flow nodes FN1 and FN2 is only included in the diagram if the edge from FN1 to FN2 is traversed in the same direction as the edge that brought FN1 into the diagram. • This setting is optional. • You can choose one of the following values: <ul style="list-style-type: none"> • <code>"flow"</code>: The node is part of the flow. This is the default setting. • <code>"context"</code>: The node is part of the context. When you select the Flow/Context layout for a diagram, the edges between flow nodes are rendered horizontally, mostly from left to right (the from node is to the left of the to node). The edges from flow to context nodes are rendered vertically, from bottom to top.

JSON syntax	Description
<code>"label": "Term"</code>	<ul style="list-style-type: none"> • Determines the name that is displayed on the node in the diagram design view. For a node that represents a complex relation type, the label is used in the diagram as well. • This setting is optional. • You can provide any string as the value. If you do not specify a label, the name of the asset type or the complex relation type is used.
<code>"collapsed": false, true</code>	<ul style="list-style-type: none"> • Indicates if the selected node is collapsed in the initial diagram. • This setting is optional. • You can choose one of the following values: <ul style="list-style-type: none"> ◦ <code>false</code>: The selected node is a boxing node and the boxed nodes are displayed. ◦ <code>true</code>: The selected node is a boxing node and the boxed nodes are hidden.
<code>"name":</code>	<ul style="list-style-type: none"> • Defines the name that has to be displayed on the node. By default, this is the asset's name, but you can specify any characteristic. Use the same syntax as for <code>"fields"</code>.

JSON syntax	Description
<pre>"fields":</pre>	<ul style="list-style-type: none"> • Defines which characteristics are shown in the node's overlay. The order of the fields determines the order of the characteristics in the overlay. • This setting is optional. • You can pick one or more of the following values: <ul style="list-style-type: none"> ◦ "name": The asset's name, as defined in the "name": setting. ◦ "status": The asset's status value. ◦ "domain": The domain in which the asset is located. ◦ "community": The lowest-level community in which the asset is located. ◦ "assetType": The asset's type. <div data-bbox="767 987 1417 1211" style="border: 1px solid #ccc; background-color: #f9f9f9; padding: 10px; margin: 10px 0;"> <p>Note When filtering a diagram by asset type, keep in mind that all subtypes are included, meaning they pass the filter along with the specified asset type.</p> </div> <ul style="list-style-type: none"> ◦ "tags": Any tags that were created for the asset. ◦ "responsibility_<ID>": The overlay is a resource role type with the ID that you type here. The diagram shows the avatars of users and user groups that have this role for this asset. ◦ "createdOn": The date when the asset was created. ◦ "createdBy": The name of the user who created the asset. ◦ "lastModifiedOn": The date and time when the asset was last modified. ◦ "lastModifiedBy": The name of the user who last modified the asset.

JSON syntax	Description
	<ul style="list-style-type: none"> ◦ "stringAttribute_<ID>": The overlay is a string attribute type with the ID that you type here. Example: "stringAttribute_00000000-0000-0000-0000-000000000001" ◦ "dateAttribute_<ID>": The overlay is a date attribute with the ID that you type here. ◦ "numericAttribute_<ID>": The overlay is a date attribute with the ID that you type here. ◦ "booleanAttribute_<ID>": The overlay is a boolean attribute with the ID that you type here. ◦ "singleValueListAttribute_<ID>": The overlay is a single-selection attribute with the ID that you type here. ◦ "multiValueListattribute_<ID>": The overlay is a multi-selection attribute with the ID that you type here. ◦ "dataQualityRule_<ID>": The overlay is the percentage score of a data quality metric group with the ID that you type here. The score overlay shows the percentage, the color (red/amber/green) and trend (up/down/flat). ◦ "sourceRelation_<ID>": The overlay is a relation type where the node is a tail asset and has the ID that you type here. ◦ "targetRelation_<ID>": The overlay is a relation type where the node is a head asset and has the ID that you type here.

JSON syntax: Edges section

The edges settings determine which directed relations should be traversed, and how they should be depicted on the diagram. Each edge represents a relation type between two

nodes (asset types or complex relation types) in the view.

You have to ensure that the diagram view is a connected graph: each node in the diagram view is reachable from any other node.

JSON syntax	Description
<code>"from": "Business Asset"</code>	<ul style="list-style-type: none"> Indicates which node is the head asset. This setting is mandatory. You must fill in a node ID ("id") from the nodes section.
<code>"to": "Table Column1"</code>	<ul style="list-style-type: none"> Indicates which node is the tail asset. This setting is mandatory. You must fill in a node ID ("id") from the nodes section.
<code>"type": "00000000-0000-0000-0000-000000007038"</code>	<ul style="list-style-type: none"> Indicates the ID of the relation type. This setting is mandatory. You have to fill in the resource ID of the relevant relation type. You can copy and paste these resource IDs from the Settings UI: <ul style="list-style-type: none"> Attribute type. Relation type. Complex relation type.
<code>"roleDirection": true, false</code>	<ul style="list-style-type: none"> Determines the direction of the edge; is it the role or co-role. This setting is mandatory. You can pick one of the following values: <ul style="list-style-type: none"> <code>true</code>: The edge is traversed from head to tail. <code>false</code>: The edge is traversed from tail to head.

JSON syntax	Description
<pre>"style": "arrow", "boxed", "boxing"</pre>	<ul style="list-style-type: none"> • Determines how edges are displayed. • This setting is optional. • You can pick one of the following values: <ul style="list-style-type: none"> • "arrow": The edge is represented by an arrow. The arrow starts at the 'from' node and ends at the 'to' node. This is the default setting. • "boxing": The edge is represented as a 'from' asset that boxes one or more 'to' assets. In other words, a head asset contains one or more tail assets. • "boxed": The edge is represented as a 'from' asset that is boxed by a 'to' asset. In other words, a tail asset contains one or more head assets.
<pre>"label": "Groups"</pre>	<ul style="list-style-type: none"> • Determines the name that is displayed on edges in the diagram. • This setting is optional. • If you do not specify a label, the role or co-role of the relation type from the operating model is used, in both the diagram view and the diagram. If "roleDirection" is <i>true</i>, Collibra DGC uses the role, if it is <i>false</i>, it uses the co-role.

Tips for creating correct diagram views with the diagram view text editor

Although you can create and edit diagram views via the [text editor](#), we recommend that you use the graphical view editor when possible. However, if you want to configure advanced filter expressions for a diagram, you have to complete the configuration via the diagram view text editor.

Each change that you make via the graphical view editor is reflected in the text editor and vice versa.

Tips

- Collibra Data Governance Center checks the full syntax of your JavaScript Object Notation (JSON) as you type. If the JSON code is incorrect, Collibra DGC detects this immediately and the **Save** button remains inactive.

```

1 {
2   "nodes": [
3     {
4       "id": "Table Column",
5       "layoutRegion": "flow",
6       "type": {
7         "id": "00000000-0000-0000-0000-0000000031000"
8       }
9     },
10    {
11      "id": "Field Mapping",
12      "layoutRegion": "flow",
13      "type": {
14        "id": "00000000-0000-0000-0000-000000007502"
15      }
16    },
17    {
18      "id": "Table",
19      "layoutRegion": "context",
20      "type": {
21        "id": "00000000-0000-0000-0000-0000000031007"
22      }
23    },
24    {
25      "id": "Business Term",
26      "layoutRegion": "context",
27      "type": {
28        "id": "00000000-0000-0000-0000-0000000011001"
29      }
30    },
31    {
32      "id": "Mapping Specification",
33      "layoutRegion": "context",
34      "type": {
35        "id": "00000000-0000-0000-0000-0000000031030"
36      }
37    }
38  ]
39  "edges": [
40    {
41      "from": "Table Column",
42      "to": "Business Term",
43      "roleDirection": false,

```

For example:

- If you omit the required comma between two key-value pairs, Collibra DGC shows an error message, and highlights the offending line.
- If you make a typo in a value, Collibra DGC shows an error and displays the allowed values.
- JSON is a case-sensitive language. This means that you must use the exact key-value pairs as they are described in this guide.
- The code must contain a **nodes** section and an **edges** section. The order of the sections is irrelevant. Layout to improve readability (spaces, tabs, empty lines), is irrelevant.
- Collibra DGC checks if each resource ID (conceptTypeId, binaryFactTypeId, attributetypeID) that you specified, exists in the operating model. If a resource ID does not exist, it is removed from the diagram view and a warning and an error are displayed. Collibra DGC does not save your view unless you correct the error.

```

29  },
30  "edges": [
31    {
32      "from": "Data Structure",
33      "to": "Business Asset",
34      "roleDirection": false,
35      "type": {
36        "id": "00000000-0000-0000-0000-000000007038"
37      }
38    },
39    {
40      "from": "Data Structure",
41      "to": "Mapping Specification",
42      "roleDirection": true,
43      "type": {
44        "id": "00000000-0000-0000-0000-000000007028"
45      }
46    },
47    {
48      "from": "Mapping Specification",
49      "to": "Data Structure",
50      "roleDirection": false,
51      "type": {
52        "id": "00000000-0000-0000-0000-000000007029"
53      }
54    },
55    {
56      "from": "Business Assets",
57      "to": "Business Asset",
58      "roleDirection": true,
59      "type": {
60        "id": "00000000-0000-0000-0000-000000007001"
61      }
62    },
63    {
64      "from": "Business Assets",
65      "to": "Business Dimension",
66      "roleDirection": false,
67      "type": {
68        "id": "00000000-0000-0000-0000-000000007007"
69      },
70      "style": "boxed"
71    }
72  ],

```

Errors: 2

- Edge with index 3 points to an unknown node with ID Business Assets.
- Edge with index 4 points to an unknown node with ID Business Assets.

- Collibra DGC checks if the diagram view is a connected graph. A diagram view is a connected graph when every node can be reached from any other node by traversing the edges. If the diagram is not connected, a warning is displayed. Collibra DGC does not save your view unless you correct the error.
- You can create key-value pairs with a key name that is not listed in this guide. These key-value pairs are allowed in the code but are ignored. As such, typos in the key names do not trigger Collibra DGC to show a warning or error. You can use this to your advantage, for example, to add comments to the JSON view.

Pin a diagram view

You can pin a [diagram view](#) in the dropdown of the view selection field:

- While [creating it](#).
- [From the diagram editor](#).
- [From the diagram view list](#).

Pin a view from the diagram editor

1. [Open](#) a diagram view.
2. Click .
 - » The **Share view** dialog box appears.
3. Select the **Pin** check box.
4. Click **Save**.

Pin a view from the diagram view list.

1. [Open](#) a diagram view.
2. Click the current view name and click **Show all...** at the bottom.
 - » The available views appear.
3. Click  in front of the views you want to pin.

Unpin a diagram view

You can unpin a [diagram view](#) to remove it from the dropdown of the view selection field:

- [In the diagram editor.](#)
- [In the diagram view list.](#)

Unpin a view in the diagram editor

1. [Open](#) a diagram view.
2. Click .
 - » The **Share view** dialog box appears.
3. Clear the **Pin** check box.
4. Click **Save**.

Unpin a view in the diagram view list.

1. [Open](#) a diagram view.
2. Click the current view name and click **Show all...** at the bottom.
 - » The available views appear.
3. Click  in front of the views you want to pin.

Set a diagram view as default

Setting a [diagram view](#) as default for an asset means that you indicate that this diagram view is the one to be used initially, when the users with whom you shared this diagram view display a diagram for an instance of this asset type and all its child asset types.

Steps

1. [Open](#) a diagram view.
2. Click .
- » The **Share view** dialog box appears.
3. Select the **Default** check box.
4. Click **Save**.

Share a diagram view

You can share a [diagram view](#) with other users or make it private.

Users with whom the diagram view is shared can only [edit](#) the diagram view if they also have the **Manage and share anyone's Views, Dashboards, Search filters** permission.

Note By default, diagram views are public.

Steps

1. [Open](#) a diagram view.
2. Click .
- » The **Share view** dialog box appears.

3. Enter the required information.

Field	Description
Sharing options	This section determines who has access to this diagram view.
Public	Select to share this diagram view with all users.
Private	Select to share this diagram view with no one.
Share with specific roles, groups & users	Select to choose with whom to share the diagram view.
Roles	Select or type the roles whose users you want to give access.
Groups	Select or type the groups whose users you want to give access.
Users	Select or type the users to whom you want to give access.
Promote	
Default	Select to use this diagram view as the default view when you open the diagram editor.
Pin	Select to pin the diagram view. Pinned diagram views appear in the view selection drop-down list.

4. Click **Save**.

Work with filters in a diagram view

When you create a diagram view, you can configure filters to only keep the nodes that you are interested in or to limit the number of nodes that are shown in a diagram.

Note Users can enable or disable all filters in the [diagram toolbar](#).

Steps

1. [Open](#) a diagram view.
2. Click .
 - » The **General properties** form appears.
3. Select a node in the diagram.
 - » The **Node properties** form appears.

4. In the **Node properties** form, go to the **Filters** section.
5. Do one of the following:

Action	Description		
Filtering by business qualifier	<table border="1"> <thead> <tr> <th data-bbox="488 416 679 566">Collibra v- ersion</th> <th data-bbox="679 416 1412 566">Action</th> </tr> </thead> </table>	Collibra v- ersion	Action
	Collibra v- ersion	Action	
	2021.01	Select the Filtering by business qualifier checkbox to filter a diagram to contain only the assets or complex relations that are qualified by the chosen business qualifier.	
2021.02 or newer	<p>In the Filtering by business qualifier drop-down list, select one of the following settings:</p> <ul style="list-style-type: none"> ◦ Mandatory: The diagram only contains assets or complex relations that match this view node and are qualified by the chosen business qualifier. ◦ Optional: The diagram includes: <ul style="list-style-type: none"> ▪ Assets or complex relations that match this view node and are qualified by the chosen business qualifier. ▪ Assets or complex relations that match this view node and are not qualified by any business qualifier. 		
<p>Note</p> <ul style="list-style-type: none"> ◦ This feature is only available if it is enabled in Collibra Console. ◦ You can apply filtering by business qualifier to view nodes that represent asset types or complex relation types. 			

Action	Description
Add a simple filter	<p>Select a characteristic and enter one or more values. Click Add filter criteria to add more filter criteria.</p> <div style="border: 1px solid #ccc; padding: 10px; background-color: #f9f9f9;"> <p>Tip</p> <ul style="list-style-type: none"> You can add multiple values for a characteristic. If you select multiple values, the filter clause uses the IN operator. In other words, any of the values is accepted. Example: <div style="border: 1px solid #ccc; padding: 5px; margin-bottom: 10px;"> <p>A Domain 🗑️</p> <p>BA Domain ⌵</p> <p>Data Quality Dimensions ⌵</p> </div> <p><i>reads Domain IN (BA Domain, Data Quality Dimensions)</i></p> <ul style="list-style-type: none"> You cannot use wildcards in the value of a filter clause. If you use multiple filter clauses, they are always combined with the logical AND operator. In other words, all filter clauses have to be met. </div>
Configure advanced filter expressions	See Configure an advanced filter expression in a diagram view .
Edit a filter	Edit the filter criteria to match your needs.
Delete a filter	Click 🗑️ to delete a filter criterion.

6. Above the diagram, to the right, click **Save**.

Configure an advanced filter expression in a diagram view

To configure advanced filter expressions for diagrams, you have to complete the configuration via the diagram view JSON [text editor](#).

Steps

1. Add a simple filter, as described in [Work with filters in a diagram view](#).
2. Click the **Text** tab, to switch to the diagram view text editor.
3. Find the node on which you created the simple filter and change the **IN** operator to one of the following operators:

Operators for attributes kinds "text" and "plain text"

- IN
- NOT_IN
- CONTAINS
- NOT_CONTAINS
- STARTS_WITH
- NOT_STARTS_WITH
- ENDS_WITH
- NOT_ENDS_WITH

Note The operators EXISTS and NOT_EXISTS do not work in advanced filter expressions for diagrams.

Operators for attribute kinds "date" and "number"

- IN
 - NOT_IN
 - LESS
 - LESS_OR_EQUALS
 - GREATER
 - GREATER_OR_EQUALS
4. Above the diagram, to the right, click **Save**.

Examples and additional information

Example of a node with a filter on the Report Attribute asset type

Filtering by asset type is particularly useful for diagrams. When filtering a diagram by asset type, keep in mind that all subtypes are included, meaning they pass the filter along with the specified asset type.

```

{
  "layoutRegion": "flow",
  "id": "Report Attribute",
  "type": {
    "id": "00000000-0000-0000-0000-000000031027"
  },
  "filters": [
    {
      "operator": "IN",
      "values": [
        "00000000-0000-0000-0000-000000031027"
      ],
      "field": "assetType"
    }
  ]
},

```

Example of a node with a filter on a data attribute

You have to provide the value in Unix Epoch datetime, in milliseconds. This example is for a custom date attribute to be greater than 2020-okt-1.

```

{
  "operator": "GREATER",
  "values": [
    "1601483854000"
  ],
  "field": "dateAttribute_7ff7f6af-33d3-4fdf-8ac5-bf918606315f"
}

```

For more information on configuring advanced filter expressions in the diagram view text editor, see:

- [JSON syntax: Nodes section](#)
- [Tips for creating correct diagram views with the JSON text editor](#)

Filtering by business qualifier

Filtering by business qualifier allows you to filter a diagram to contain only assets or complex relations that are qualified by a chosen business qualifier. The difference from traditional filtering is that the filter value is not fixed in the diagram view; instead, the user can choose the business qualifier to filter by in the result diagram, without having to

change the view. This is a form of dynamic filtering. We refer to such a diagram as a business qualifier diagram.

Business qualifier diagrams are smaller and load faster than "unqualified" diagrams, and their focused qualifier makes them easier to understand.

The following is true of every asset in a business qualifier diagram:

- Every asset matches a node in the business qualifier view.
- Every asset can be reached from the start asset by selecting the view and applying the normal traversal strategy. In other words, the asset would be included in an ordinary diagram.
- Every asset has a business qualifier path to the selected business qualifier.

For descriptions of these terms, see [Terminology](#).

Enabling business qualifier diagrams

To view Business Qualifier diagrams, the feature has to be enabled in Collibra Console.

If enabled in Collibra Console, the **Filtering by business qualifier** option is shown in the **Filters** section of the [Node properties](#) form, when [editing](#) a diagram view. The filter icon appears on the nodes for which the option is selected, like on any other node for which a filter is applied.

Note To make the feature available to users, a **Filtering by business qualifier** option (either Optional or Mandatory) has to be selected for at least one view node.

Key asset type and relation types

The various business qualifiers that can "qualify" assets and complex relations in a business qualifier diagram are represented by Business Qualifier assets.

When filtering by business qualifier, the start node can be a Business Qualifier asset, a Column asset or a complex relation.

Business Qualifier assets

Business Qualifier assets relate to other assets by the following packaged relation type:

Head	Role	Co-role	Tail
Business Qualifier	qualifies	is qualified by	Asset

Column assets

Column assets relate to Business Attribute assets that are related to Business Qualifier assets. The packaged relation types are the following:

Head	Role	Co-role	Tail
Business Qualifier	qualifies	is qualified by	Data Attribute
Data Attribute	groups	is grouped by	Column

Complex relations

When [configuring](#) business qualifier filtering for complex relations, you need to edit the relevant complex relation type and add a relation leg pertaining to the Business Qualifier asset.

Edit Field Mapping
✕

Name*

Description

Display options

Color*

Color hex value

Symbol

Icon reference*

Preview

☰ Field Mapping

☰ Field Mapping

Relations

	Role*	Corole	Asset type*	Min.	Max.	
+	<input type="text" value="source"/>	<input type="text"/>	<input type="text" value="Data Element"/>	<input type="text" value="1"/>	<input type="text"/>	✕
+	<input type="text" value="target"/>	<input type="text"/>	<input type="text" value="Data Element"/>	<input type="text" value="1"/>	<input type="text"/>	✕
+	<input type="text" value="mapping specification"/>	<input type="text"/>	<input type="text" value="Mapping Specification"/>	<input type="text" value="1"/>	<input type="text" value="1"/>	✕
+	<input type="text" value="is qualified by"/>	<input type="text"/>	<input type="text" value="Business Qualifier"/>	<input type="text" value="0"/>	<input type="text"/>	✕

Add relation

Attributes

	Attribute type	Min.	Max.	
+	<input type="text" value="Description"/>	<input type="text" value="0"/>	<input type="text" value="1"/>	✕
+	<input type="text"/>	<input type="text"/>	<input type="text"/>	✕

Cancel
Save

Terminology

Term	Description
Business qual- ifier view	A diagram view with at least one node for which a Filtering by business qualifier option is selected .

Term	Description
Business qualifier diagram	<p>A diagram for which all of the following conditions are met:</p> <ul style="list-style-type: none"> • The selected diagram view is a business qualifier view. • Filters are enabled in the diagram toolbar. • Either the start node is a Business Qualifier asset, or both of the following are true: <ul style="list-style-type: none"> ◦ The start node matches a view node that has a Filtering by business qualifier option (either Optional or Mandatory) selected. ◦ The start node has at least one Business Qualifier path.
Business qualifier path	<p>An asset has a business qualifier path if either of the following is true:</p> <ul style="list-style-type: none"> • The asset has at least one relation asset qualified by a Business Qualifier asset. • The asset is a Column, and both: <ul style="list-style-type: none"> ◦ The Column asset is grouped by a Data Attribute asset. ◦ That Data Attribute asset is qualified by a Business Qualifier asset.

Configure business qualifier filtering for a complex relation

You can configure [business qualifier filtering](#) for a complex relation.

Prerequisites

- To edit a complex relation type, you need a [global role](#) that has the System administration [global permission](#).
- The Diagrams Business Qualifier Filter is [enabled](#) in Collibra Console.

Steps

Tip See the following example for detailed instruction on how to carry out each step in this procedure.



1. **Edit** the relevant complex relation type, for example Field Mapping. Specifically, you need to add a relation leg pertaining to the Business Qualifier asset.
2. If not already done, **create** the Business Qualifier asset that you will use to filter a diagram.
3. Specify the Business Qualifier asset in the complex relation type.
4. **Add** a relation between the relevant assets.

Tip We are referring here to assets that are the head or tail of the complex relation type legs, for example Column assets and the Business Qualifier asset.

5. In the relevant diagram view, enable the **Filtering by Business Qualifier** option for both the Column asset node and the Field Mapping complex relation node.

Show me an example

In this example, we are working with the commonly used Field Mapping complex relation type that comes packaged with Collibra Data Intelligence Cloud. As the Field Mapping complex relation type is often used to track the flow of metadata from source column to target column, we also refer in this example to the Data Element asset type, which is a parent of the Column asset type. Lastly, the Field Mapping complex relation type is, by default, included the global role of the Data Element asset type.

1. Start by editing the Field Mapping complex relation type. Specifically, you need to add a relation leg pertaining to a Business Qualifier asset.
 - a. In the main menu, click , then  **Settings**.
 - » The [Collibra DGC settings page](#) opens.
 - b. In the **Operating model** section, click **Complex relations**.

- c. In the table, find the Field Mapping row and click  at the end of the row.
 » The **Edit Field Mapping** dialog box appears.

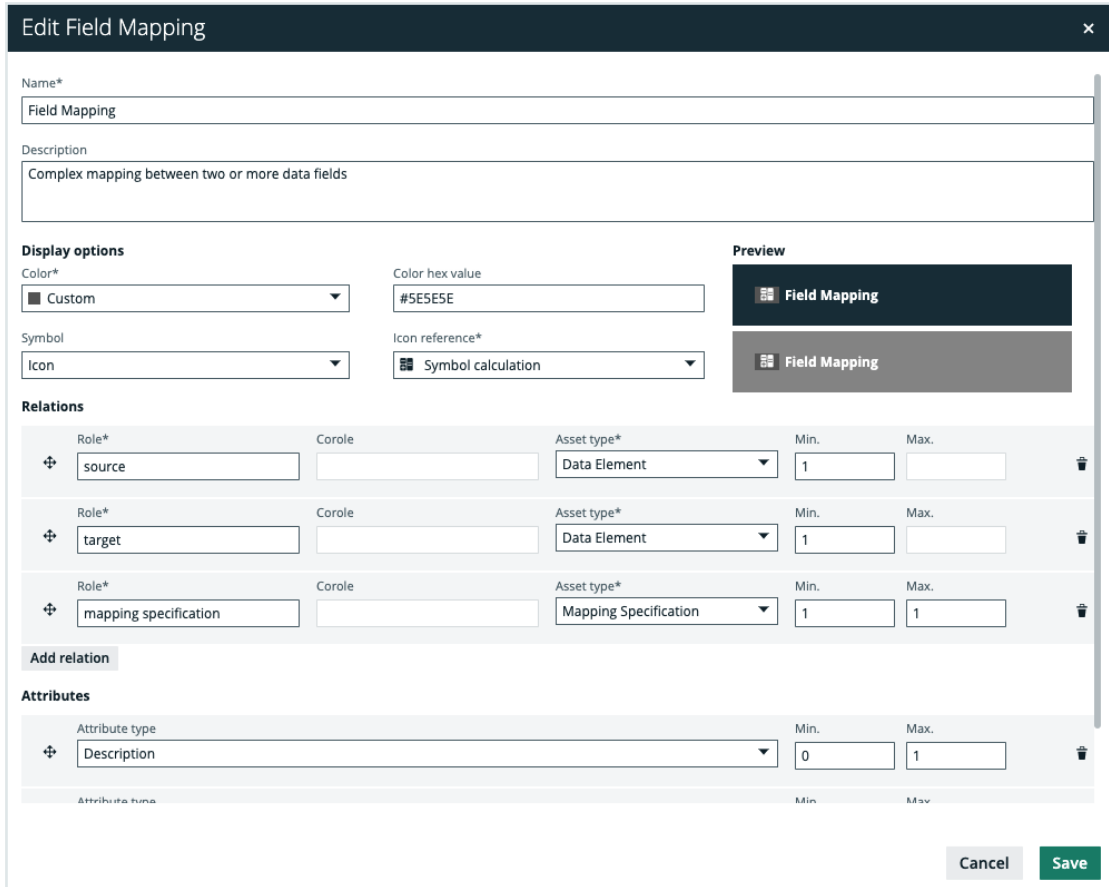

- d. At the bottom of the **Relations** section, click **Add relation**.
 e. Enter the required information.



- **Role:** We recommend the value *is qualified by*, but you can enter any text value that suits your needs.
- **Asset type:** Business Qualifier.

Leave the default values for the other fields as they are.

- f. Click **Save**.
2. Let's assume that no appropriate Business Qualifier asset exists. Therefore, you need to create one.
- a. In the main menu, click the **Create (+)** button.
 » The **Create** dialog box appears.

b. Click the **Assets** tab.

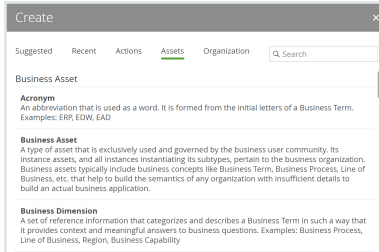

c. In the list of asset types, click Business Qualifier.

» The **Create Asset** dialog box appears.

d. Enter the required information.

Field	Description
Type	The asset type of the asset that you are creating. In this case, <i>Business Qualifier</i> .
Domain	The domain to which the new assets will belong. You can only create a asset type in any domain of a domain type that is assigned to a selected asset type.
Name	The name of the new Business Qualifier asset. For our example, let's use: <i>BQ1</i> .

e. Click **Create**.

» A message at the top-right of your screen confirms that one or more assets are created.

3. Specify the Business Qualifier asset in the complex relation type.

a. Open one of the relevant leg assets. Let's choose one of the Column assets.

b. In the tab pane, click **Details**.

c. In the **Field Mapping** section, hover your pointer over any of the assets, and then click .

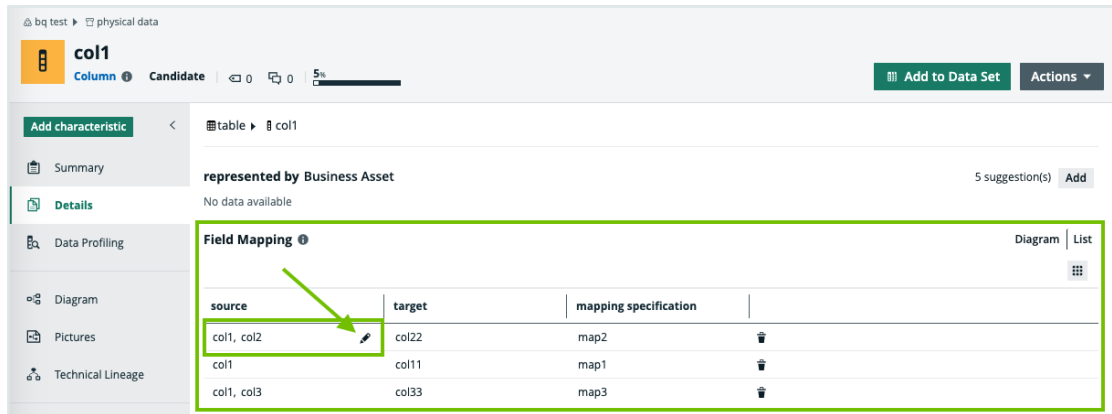

» The **Edit Field Mapping** dialog box appears. Notice that the "is qualified by" relation leg is empty.

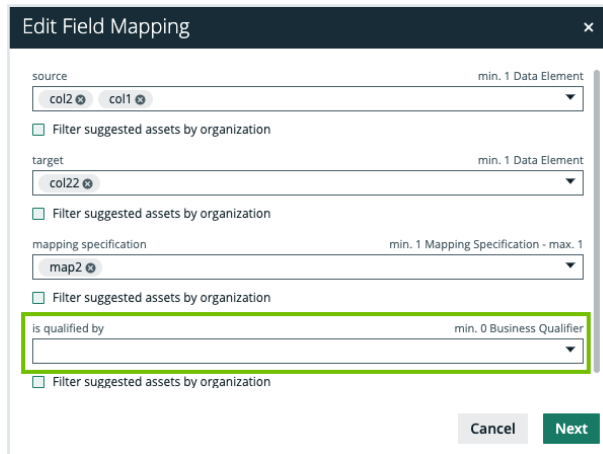

d. In the **is qualified by** field, add the Business Qualifier asset. In this example, BQ1.

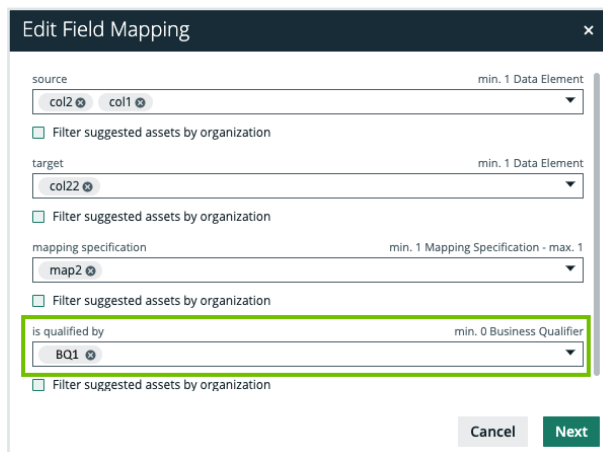



e. Click **Next**.

f. If necessary, add a description of the Field Mapping complex relation.

- g. Click **Finish**.
4. Now **add** a relation between a Column asset and the Business Qualifier asset.
 - a. Open one of the relevant Column assets.
 - b. In the tab pane, click **Add Characteristic**.
 - » The **Add a characteristic** dialog box appears.
 - c. Click **Relations**.
 - d. Search for and click **is qualified by Business Qualifier**.
 - » The **Add is qualified by Business Qualifier** dialog box appears.
 - e. Enter the required information.

Option	Description
Assets	The name of the Business Qualifier asset. In this example, BQ1.
Start date	Optionally enter the date on which the relation between the assets becomes applicable.
End date	Optionally enter the date on which the relation between the assets is no longer applicable. Leave this field empty to create a permanent relation.

- f. Click **Save**.
5. In the relevant diagram view, enable the **Filtering by Business Qualifier** option for both the Column asset node and the Field Mapping complex relation node.
 - a. Open a relevant Column asset page.
 - b. In the tab pane, click  **Diagram**.
 - » The diagram appears in the default **diagram view**.
 - c. If necessary, **select** a different diagram view.
 - d. Click .
 - » The **General properties** form appears.
 - e. Select a node in the diagram.
 - » The **Node properties** form appears.

Tip You need to carry out steps e-h for both the Column asset node and the Field Mapping complex relation node.

- f. In the **Node properties** form, go to the **Filters** section.
- g. Enable business qualifier filtering:

Your Col-libra version	Action
2021.01	Click the Filtering by business qualifier checkbox.
2021.02 or newer	In the Filtering by business qualifier drop-down list, select Mandatory , so that the diagram will only contain assets matching this view node that are qualified by the chosen business qualifier.

- h. Above the diagram, to the right, click **Save**.
- i. In the **diagram toolbar**, click the **Business qualifier** drop-down menu and select **BQ1**.

Delete a diagram view

You can delete a [diagram view](#).

Steps

1. Open an asset page.
2. In the tab pane, click **Diagrams**.
3. Select the diagram view that you want to delete.
4. In the view bar, click .
5. Click **Delete view**.

Pictures

A picture is a copy of a diagram that is stored separately from the original. You can edit the pictures in the same way you edit diagrams, but there are fewer options available.

Pictures are an easy way to save a diagram after you configured it. You can then reuse it later.

Available actions

- [Create](#) a picture.
- [Open](#) a picture.
- [Edit](#) a picture.
 - a. [Select](#) a layout.
 - b. [Zoom](#) in or out.
 - c. [Expand or collapse](#) nodes.
 - d. [Trace](#) a path between nodes.
 - e. [Move](#) nodes, enable or disable labels, the legend, and so on.
- [Export](#) a picture.
- [Delete](#) a picture.

Picture editor

The picture editor allows you to view and edit [pictures](#). You can access the picture editor by [opening a picture](#).

Technical Lineage

1

Table Columns flow through Field Mappings with Table context









No	Name	Description
1	Picture name	The name of the picture.
2	Picture toolbar	The toolbar to work in the picture.







No	Name	Description
3	View bar menu	The buttons to edit the picture's name, share it or delete it.
4	Picture	This is the actual depiction of the traceability of the current asset, according to the picture you opened .
5	Overview ()	Zoom and navigate a picture that is too large to fit the screen. You can move it to anywhere in the diagram.
6	Legend	<p>The legend explains the color codes and symbols of the items in the picture. You can move it to anywhere in the picture.</p> <p>For each asset type and complex relation type that is visible on the picture, the legend shows the color and symbol, followed by the name of the type.</p> <p>If all occurrences of a given type are boxed inside collapsed boxing nodes, that type is not visible and therefore, not shown in the legend.</p> <div style="border: 1px solid #ccc; background-color: #f9f9f9; padding: 10px; margin-top: 10px;"> <p>Tip Click a row in the legend to select all occurrences of that type in the picture. You can use this to expand or collapse all nodes of the same type.</p> </div>
7	Preview panel	The preview panel with information about the selected node.
8	Time stamp	The date and time on which the picture was created .

Picture toolbar

The toolbar of the [picture editor](#) helps you to edit settings that apply to the entire [picture](#).



Button	Name	Description
	Layout	Select a layout . The layout determines the location of nodes and edges, but does not change which nodes and edges are shown.
	Zoom in	Zoom in on the picture.
	Zoom out	Zoom out from the picture.
1:1	Zoom to readable value	Zoom the picture to a size that is readable.
	Shrink to fit	Zoom the picture to a size that fits the screen.
	Overview	Show or hide the overview inset that enables you to zoom and navigate.
	Labels	Show or hide the labels of the edges and complex relations.
	Overlays	Show or hide overlays for all nodes in the picture . If the view does not have any defined overlays, the button is grayed out.
	Export	Export the picture as a PDF or SVG file to your default downloads folder.
	Redraw	Discard all the changes that you made to the picture and restore it to the initial state.

Button	Name	Description
	Legend	<p>Show or hide the legend panel containing the explanation of the nodes.</p> <p>The legend explains the color codes and symbols of the items in the picture. You can move it to anywhere in the picture.</p> <p>For each asset type and complex relation type that is visible on the picture, the legend shows the color and symbol, followed by the name of the type.</p> <p>If all occurrences of a given type are boxed inside collapsed boxing nodes, that type is not visible and therefore, not shown in the legend.</p> <div style="border-left: 2px solid green; padding-left: 10px; margin-top: 10px;"> <p>Tip Click a row in the legend to select all occurrences of that type in the picture. You can use this to expand or collapse all nodes of the same type.</p> </div>
	Preview	Show or hide the preview panel on the right side of the screen. It contains information about the characteristics of the currently selected node (asset or complex relation).
	Picture	Create a picture based on the picture.
	Find	Find a node in the picture.
	Fullscreen	Show the current picture in full-screen mode. The button changes to  , to exit full-screen mode.

Create a picture

You can create a [picture](#) based on a diagram.

Steps

1. Open a [diagram](#) or a [picture](#).
2. Make the necessary changes.
 - a. [Select](#) a layout.
 - b. [Zoom](#) in or out.
 - c. [Expand or collapse](#) nodes.
 - d. [Trace](#) a path between nodes.
 - e. [Move](#) nodes, enable or disable labels, the legend, and so on.
3. On the toolbar, click .
 - » The **Save diagram as picture** dialog box appears.
4. Enter the required information.

Field	Description
Name*	Type a name for the picture. The default name is the name of the diagram view and a date stamp.
Description	Type a description for the picture.
Sharing options	This section determines who has access to this picture.
Public	Select to share this picture with all users.
Private	Select to share this picture with no one.
Share with specific roles, groups & users	Select to choose with whom to share the picture.
Roles	Select or type the roles whose users you want to give access.

Field	Description
Groups	Select or type the groups whose users you want to give access.
Users	Select or type the users to whom you want to give access.
Promote	
Pin	Select to pin the picture. Pinned pictures appear in the view selection drop-down list.

Fields marked with a * are mandatory.

5. Click **Save**.
 - » The resulting picture appears in the  **Pictures** section of the tab pane.

Pin a picture

You can pin a [picture](#) in the drop-down of the view selection field

- while [creating](#) it.
- [from the picture editor](#).

Pin a view from the picture editor

1. [Open](#) a picture.
2. Click .
 - » The **Share picture** dialog box appears.
3. Select the **Pin** check box.
4. Click **Save**.

Unpin a picture

You can unpin a [picture](#) to remove it from the drop-down of the view selection field

Unpin a picture in the picture editor

1. [Open](#) a diagram view.
2. Click .
- » The **Share view** dialog box appears.
3. Clear the **Pin** check box.
4. Click **Save**.

Share a picture

You can share a [picture](#) with other users or keep it private.

Steps

1. [Open](#) a picture.
2. Click .
- » The **Share picture** dialog box appears.

3. Enter the required information.

Field	Description
Sharing options	This section determines who has access to this picture.
Public	Select to share this picture with all users.
Private	Select to share this picture with no one.
Share with specific roles, groups & users	Select to choose with whom to share the picture.
Roles	Select or type the roles whose users you want to give access.
Groups	Select or type the groups whose users you want to give access.
Users	Select or type the users to whom you want to give access.
Promote	
Pin	Select to pin the picture. Pinned pictures appear in the view selection drop-down list.

4. Click **Save**.

Open a picture

You can open a [picture](#) of a [diagram](#) of an asset to visualize its relations in the [picture editor](#).

Steps

1. Open an asset page.
2. In the tab pane, click **Pictures**.
 - » The picture list appears.
3. Click a picture in the list.
 - » The picture is opened in the picture editor.



What's next?

You can now [edit](#) or [export](#) the picture.

Find node in a picture

You can search a [picture](#) for a specific node.

Steps

1. [Open](#) a picture.
2. On the toolbar, click .
 - » The search box appears.
3. Start typing in the search box.
 - » The counter next to the search box indicates how many matches are found.
 - » The first match is selected in the picture.

Tip You can use the arrows to navigate between the matches.

Edit the name and description of a picture

You can edit the name and the description of a [picture](#).

Steps

1. [Open](#) a picture.
2. Click .
 - » The **Edit name and description** dialog box appears.
3. Enter the required information.

Field	Description
Name	Type a name for the picture. The default name is the name of the original diagram view and a date stamp.
Description	Type a description for the picture.

4. Click **Save**.

Edit a picture

You can edit a [picture](#) to represent the nodes as clearly as possible.

Steps

1. [Open](#) a picture.
2. Make the necessary changes to the picture.
 - a. [Select](#) a layout.
 - b. [Zoom](#) in or out.
 - c. [Expand or collapse](#) nodes.
 - d. [Trace](#) a path between nodes.
 - e. [Move](#) nodes, enable or disable labels, the legend, and so on.

Select a picture layout

You can select a [picture layout](#) to change the way nodes are shown in a [picture](#).

Steps

1. [Open](#) a picture.
2. On the toolbar, click the layout box and select a layout.

Diagram layout	Description
Flow / Context	<p>Nodes and edges are shown in a flow and a context region.</p> <p>In the flow region, nodes are shown mostly from left to right.</p> <p>The context region is shown above the flow region. The edges that begin or end with a node in the context region are shown with less emphasis (thinner and light gray). You can choose which nodes are in the context region by selecting the Context checkbox in the node properties form.</p> <p>If there are no nodes in the context region, this layout produces the same result as Hierarchy left -> right.</p> <div style="border: 1px solid #ccc; padding: 10px; margin-top: 10px;"> <p>Note For an edge between a flow node and a context node, the 'from' node must be in the flow region and the 'to' node in the context region.</p> </div>
Hierarchy left - right	<p>Nodes and edges are shown in a flow, predominantly from left to right. This is the default layout.</p>
Hierarchy top - down	<p>Nodes and edges are shown in a flow, from top to bottom.</p>
Hierarchy bottom - up	<p>Nodes and edges are shown in a flow, from bottom to top.</p>

Diagram layout	Description
Circular	<p>Nodes and edges are arranged in a circular fashion.</p> <p>Boxing nodes are not supported in this layout, therefore:</p> <ul style="list-style-type: none"> ◦ The picture is completely redrawn. ◦ The explored nodes are removed from the picture. ◦ The nodes expand or collapse to their initial state. ◦ Returning to a layout that supports boxing nodes completely redraws the picture.
Radial	<p>Nodes and edges are shown in a radial fashion, with no overlaps, few edge crossings and few bends.</p> <p>Boxing nodes are not supported in this layout. This has the same consequences as described for the Circular layout.</p>
Smart Organic	<p>Nodes and edges are distributed in a well-balanced manner, with few edge crossings.</p>

Picture layouts

Picture layouts determine the location of nodes and edges of a [picture](#), but do not change which nodes and edges are displayed.

You can [select](#) a picture layout in the [toolbar](#) of the [picture editor](#).

Diagram layout	Description
Flow / Context	<p>Nodes and edges are shown in a flow and a context region.</p> <p>In the flow region, nodes are shown mostly from left to right.</p> <p>The context region is shown above the flow region. The edges that begin or end with a node in the context region are shown with less emphasis (thinner and light gray). You can choose which nodes are in the context region by selecting the Context checkbox in the node properties form.</p> <p>If there are no nodes in the context region, this layout produces the same result as Hierarchy left -> right.</p> <div style="border: 1px solid #ccc; background-color: #f9f9f9; padding: 10px; margin-top: 10px;"> <p>Note For an edge between a flow node and a context node, the 'from' node must be in the flow region and the 'to' node in the context region.</p> </div>
Hierarchy left - right	<p>Nodes and edges are shown in a flow, predominantly from left to right. This is the default layout.</p>
Hierarchy top - down	<p>Nodes and edges are shown in a flow, from top to bottom.</p>
Hierarchy bottom - up	<p>Nodes and edges are shown in a flow, from bottom to top.</p>
Circular	<p>Nodes and edges are arranged in a circular fashion.</p> <p>Boxing nodes are not supported in this layout, therefore:</p> <ul style="list-style-type: none"> • The picture is completely redrawn. • The explored nodes are removed from the picture. • The nodes expand or collapse to their initial state. • Returning to a layout that supports boxing nodes completely redraws the picture.

Diagram layout	Description
Radial	<p>Nodes and edges are shown in a radial fashion, with no overlaps, few edge crossings and few bends.</p> <p>Boxing nodes are not supported in this layout. This has the same consequences as described for the Circular layout.</p>
Smart Organic	Nodes and edges are distributed in a well-balanced manner, with few edge crossings.

Working with the picture overview inset

The overview inset of the [picture editor](#) allows you to keep an overview of the complete [picture](#), while the main screen is showing only a section of it.

Steps

1. [Open](#) a picture.
2. On the toolbar, click the  to show or hide the overview inset.
 - » The overview inset is shown over the picture. You can still see the picture underneath.
3. Do one of the following:

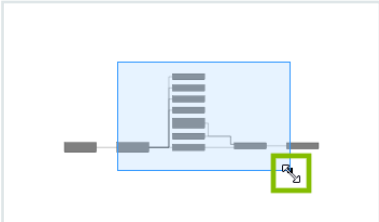
Action	Descriptions
Zoom in or out by scaling:	<ol style="list-style-type: none"> a. Move your mouse pointer over the lower right corner of the blue square, until it turns into a sleek slanted arrow. b. Click and hold, then drag the pointer to zoom in or out. 

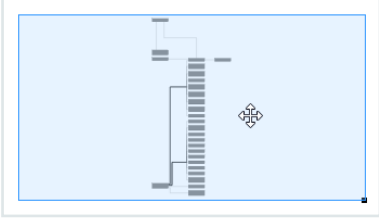
Action	Descriptions
Navigate in the picture:	<p>a. Move your mouse pointer over the blue square. The pointer turns into a four-way arrow.</p>  <p>b. Click and hold, then drag the pointer to move the square to what you want to see.</p>



Zoom in or out in the picture editor

When working with [pictures](#), you can zoom in or out in different ways.

Steps

1. [Open](#) a picture.
2. Do one of the following:

Strategy	Description
Zoom in or out with buttons.	On the toolbar, click ⊕ (Zoom in) or ⊖ (Zoom out) as needed.
Zoom in or out by scrolling with your mouse.	Move your mouse pointer to anywhere on the picture and use your mouse wheel to zoom. The zoom is centered at the mouse pointer.

Strategy	Description
Zoom in or out by scaling.	<p>a. On the toolbar, click the  button (Overview).</p> <p>An overview inset with a miniature version of the entire picture is shown in the top right corner. The section of the picture that is shown on the screen is visible as a blue rectangle on the overview.</p> <p>b. Move your mouse pointer over the lower right corner of the blue rectangle, until it turns into a sleek slanted arrow.</p>  <p>c. Click and hold, then drag the pointer to zoom in or out.</p>
Zoom to readable value.	On the toolbar, click 1:1.
Adapt the diagram to fit in the view.	On the toolbar, click  .

Trace all paths between nodes in a picture

You can trace all paths between any number of nodes on the [picture](#), which means you can show the relations between the nodes.

You can trace a path between nodes in the following ways:

- The highlight mode: Keep the whole picture and highlight the nodes and edges on the path.
- The crop mode: Remove any node or edge that is not on the path.

Steps

1. [Open](#) a picture.
2. Select one, two or more nodes in the picture:

On a macOS system	On a Windows system
Click the first one and then hold down <code>cmd</code> while clicking on the next ones.	Click the first one and then hold down <code>ctrl</code> while clicking on the next ones.

3. Do one of the following:
 - To keep the whole picture and highlight the path, right-click one of the selected nodes and click **Trace path → Highlight**.
 - To remove anything that is not part of the path between the two selected nodes, right-click one of the nodes and click **Trace path → Crop**.
 - » If you selected a single node, all relations are traced.
 - » If you selected multiple nodes, the path between the selected nodes is traced.
 - » If there is no path between the nodes, a message is displayed.

Move a node in the picture

If you want a node to be in a different location in the [picture](#), you can easily move it around.

Steps

1. [Open](#) a picture.
2. Click a node and hold down your mouse button. To select multiple nodes, do the same but select multiple nodes.

On a macOS system	On a Windows system
Click the first one and then hold down <code>cmd</code> while clicking on the next ones.	Click the first one and then hold down <code>ctrl</code> while clicking on the next ones.

3. Move the node to where you want it and release the mouse button.

Note You cannot save these changes, but you can [create](#) a picture or [export](#) the picture with these changes.

Expand or collapse picture nodes

If a node has an outgoing edge with the boxing style, it becomes a boxing node. Your diagram view determines whether boxing nodes are expanded or collapsed by default. Your diagram view can also lock collapsed nodes, which means that you cannot expand the collapsed boxing node.

Steps

1. [Open](#) a picture.
2. Do one of the following:
 - Select a node.
 - Select multiple nodes by holding down the select key and clicking nodes.

On a macOS system

Click the first one and then hold down `cmd` while clicking on the next ones.

On a Windows system

Click the first one and then hold down `ctrl` while clicking on the next ones.

- In the legend, click the asset type or complex relation type that you want to expand or collapse. You have now selected all nodes of this type.
3. Do one of the following:
 - In the node, click `+` or `-`.
 - In the context menu of a node, click **Expand/Collapse selected**.

Export a picture

You can export a [picture](#) to a PDF or SVG file.

Steps

1. [Open](#) a picture.
2. Make the necessary changes to the picture.
 - a. [Select](#) a layout.
 - b. [Zoom](#) in or out.
 - c. [Expand or collapse](#) nodes.

- d. **Trace** a path between nodes.
 - e. **Move** nodes, enable or disable labels, the legend, and so on.
3. On the toolbar, click  and select **PDF** or **SVG**.
 - » The resulting file is automatically downloaded to your default downloads folder.
 - » The default file name is **diagram.pdf** or **diagram.svg**.

Delete a picture

You can delete a [picture](#)

- [from the picture list](#).
- [from the picture editor](#).

Delete a picture from the picture list.

1. Open an asset page.
2. In the tab pane, click **Pictures**.
 - » The picture list appears.
3. At the end of a line, click .
- » The **Delete picture** dialog box appears.
4. Click **Delete picture**.

Delete a picture from the picture editor

1. [Open](#) a picture.
2. In the upper right corner, click .
- » The **Delete picture** dialog box appears.
3. Click **Delete picture**.

Diagram FAQ

Which nodes and edges are included in a diagram?

Collibra Data Governance Center only adds relevant relations and nodes to the diagram by using a specific traversal strategy. The traversal strategy is the logic that describes

which relations and assets have to be included in the diagram. To understand the traversal strategy, it is important that you know the difference between incoming and outgoing edges and between flow and context nodes.

From a start node, Collibra DGC adds all the relations (both incoming and outgoing) and the relation's node whose relation type is mentioned in the view.

When traversing further downstream from a node that is downstream from the start node, Collibra DGC adds all the relations and nodes that are downstream, but not the ones that are upstream.

When traversing further upstream, Collibra DGC adds all relations and nodes that are upstream of that node, but not the ones that are downstream.

For the following example diagram, the view contains the **Groups** relation type and **Four Wheel Vehicle** is the start node.

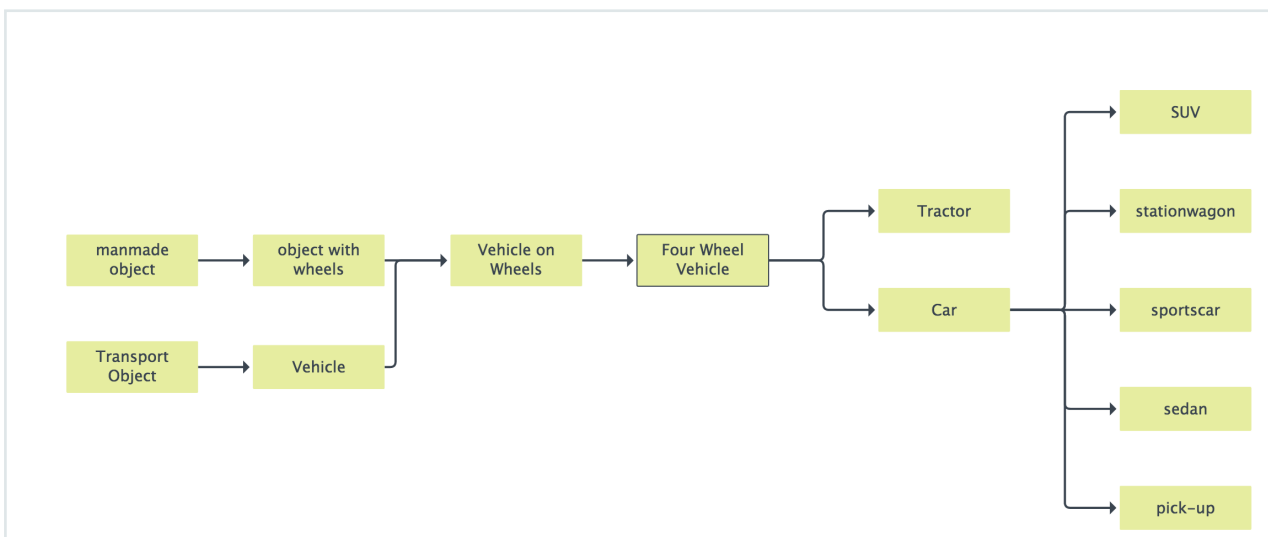

Any downstream relation of an upstream node (**Vehicle**, **Vehicle on Wheels**, ...) is irrelevant for the diagram and thus not shown. The same traversal strategy is applied to any node that is on the upstream side of a node that is downstream of the start node.

If you jump to **Vehicle**, you see that the diagram has changed for the **Vehicle on Wheels** node. This node no longer has the upstream relation to object with wheels, but the relation to **Two Wheel Vehicle** is added.

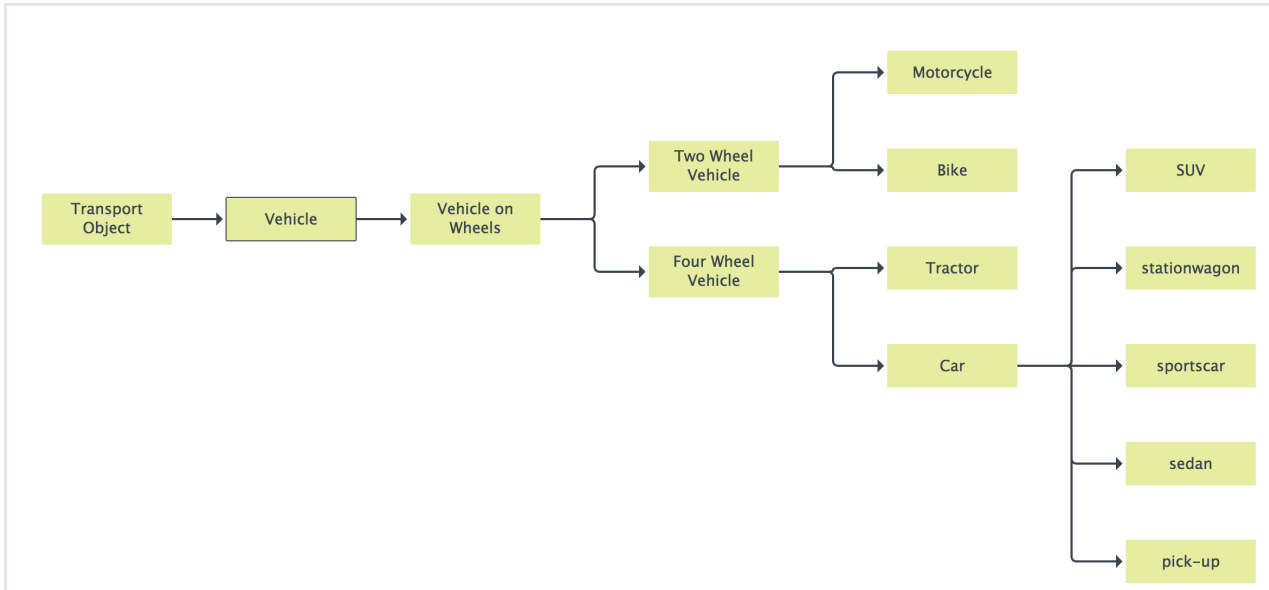

Can I set a different traversal strategy for my diagram view?

All examples in this chapter, unless mentioned otherwise, use the default traversal strategy. We call this the 'directed' traversal strategy. It can be paraphrased as 'keep on walking and don't look back'.

You can also switch the traversal strategy to complete graph, by always looking in all directions. Depending on your data, this could obviously lead to a much bigger diagram, with many more nodes and edges.

Going back to the example given in the FAQ [Which nodes and edges are included in a diagram?](#), and applying that strategy results in the following diagram:

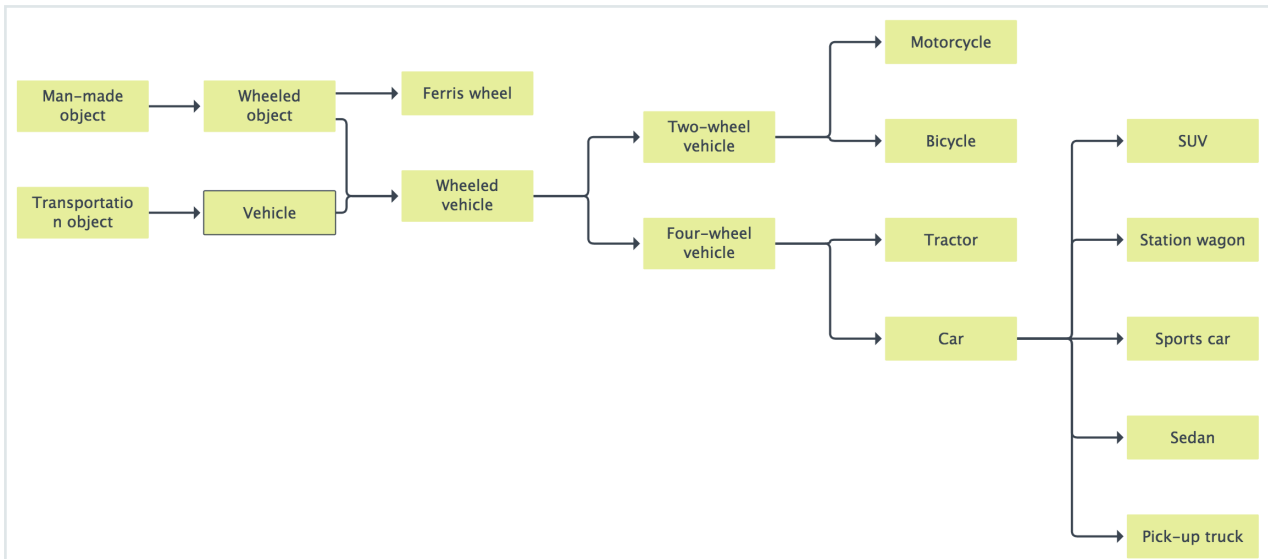

Note the new upstream branch of **Wheeled vehicle**, which is downstream from the start node. An upstream node in that branch, **Wheeled object**, has a downstream branch: **Ferris wheel**.

You can switch the traversal strategy in the JSON form of the diagram view by adding the following key-value pair to the top-level diagram section

```
"visitStrategy": "completeGraph".
```

For more information, see [Diagram views](#).

When editing a diagram view, I can assign each node to either the 'Flow' or 'Context' layout region. What does that do?

The default traversal strategy ('directed') gives the required results when you depict a set of assets that are related through some kind of (data) flow or dependency. For nodes in the flow section, and the edges between them, you can paraphrase the 'directed' traversal strategy as "keep on walking and don't look back". But when the relation represents a link to **context** rather than **flow**, the edge between two nodes should always be traversed, even if the related node is upstream of a downstream node, or vice versa. You can also regard an edge between a flow node and a context node as bidirectional: it should always be traversed.

This notion becomes clearer when you look at the following example.

When the flow depicts transformations of table columns, the tables that contain the columns, and the business terms that are related to them, provide context to the columns. The context nodes are always relevant, regardless of whether the column was encountered while going upstream or downstream. The context nodes are always added to the diagram.

For this traversal strategy, you can assign a node in the diagram view to be a **context** node.

Consider the following example diagram view:



This view contains flow only.

An example diagram for this view is below:



We started from the **Order amount USD** asset.

Now assume that you also want to see to which tables these columns belong.

You could add a relation from column to table to the view (in other words, a downstream edge), but this relation would only be considered on the downstream side, and if we add the column/table relation in the reverse direction, it would only be considered on the upstream side. To solve this problem, we designate the Table as a **context** node, so that the relation from **Column to Table** is always traversed, both for **Columns** that are upstream as well as downstream.

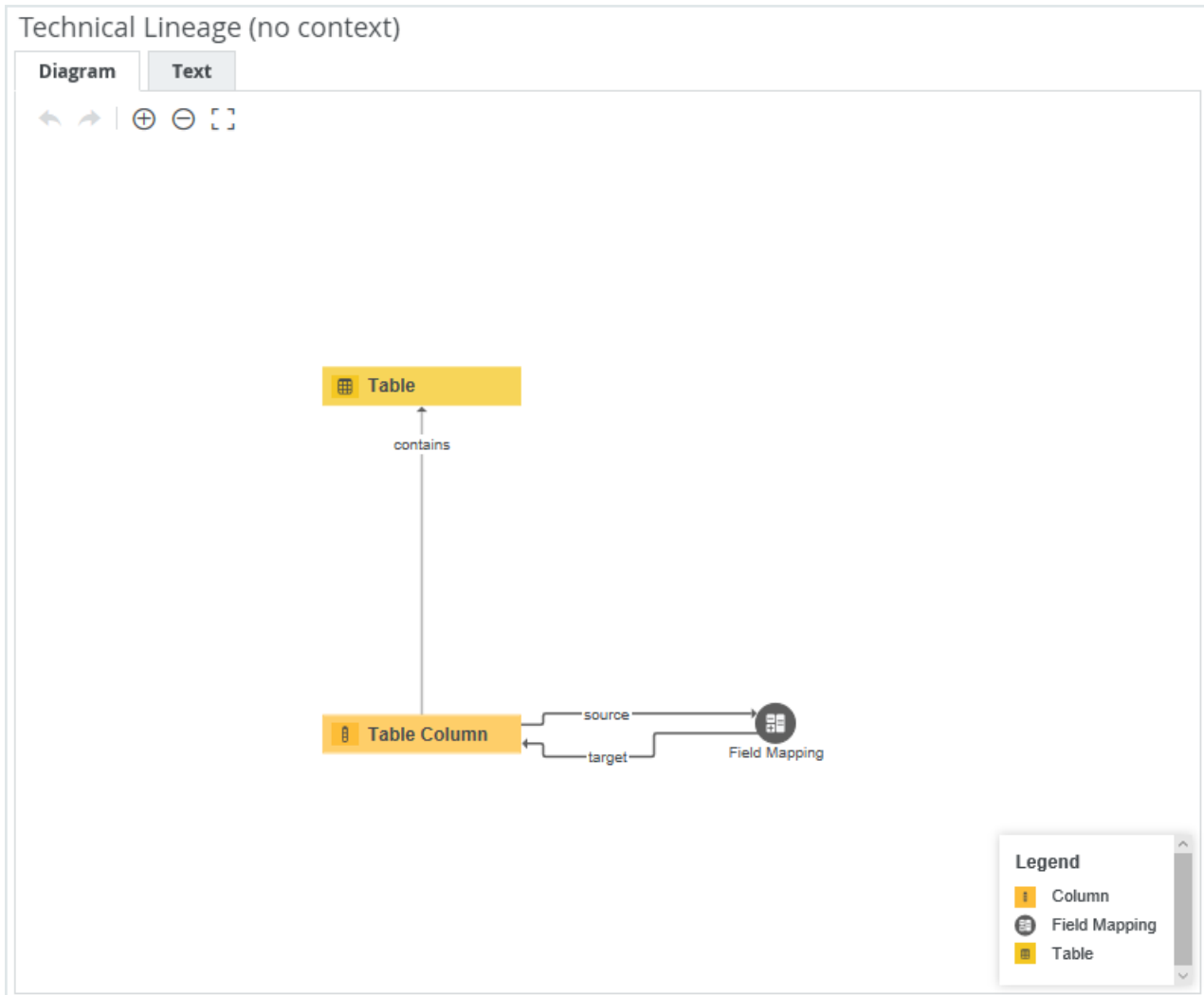

Resulting in the diagram below:

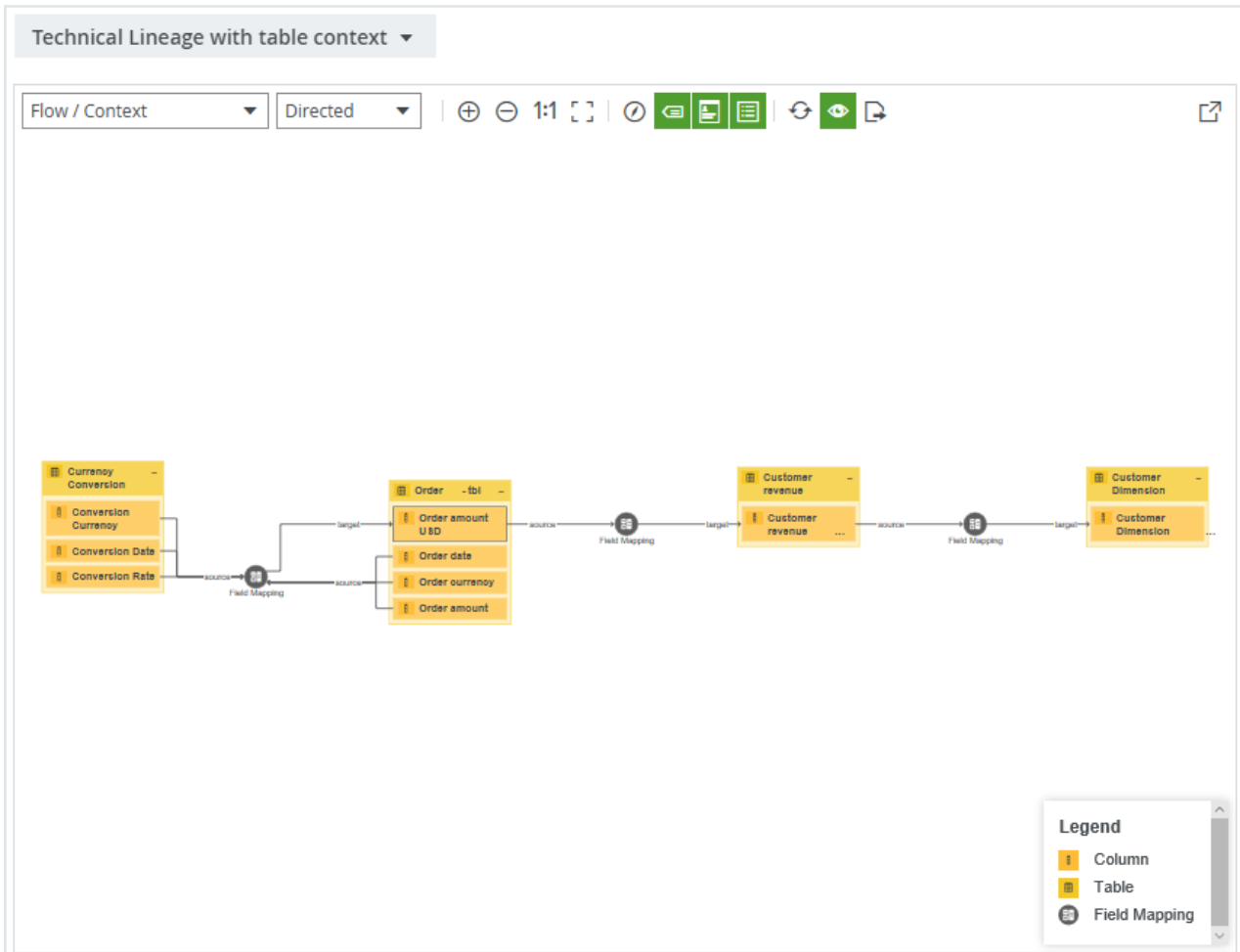

Both upstream and downstream **Columns** show the **Table** that contains them. The edge from **Column to Table** was always traversed.



What is special about the flow/context layout?

The **Flow/Context** layout is special because it has a specific behavior.

If you set the diagram layout to **Flow/Context**, the nodes that are in the **Flow** layout region, also known as flow nodes, are depicted as a left-to-right hierarchy in the lower half of the diagram. The context nodes are all in the top half of the diagram.

Note Flagging your nodes as flow or context nodes is always relevant, even when the diagram layout is not Flow/Context. For more information about how this is relevant, see [When editing a diagram view, I can assign each node to either the 'Flow' or 'Context' layout region. What does that do?](#) .

Can I change the node colors and symbols that are used for an asset type or complex relation type?

You can view and [edit](#) the color and symbol of each asset type and complex relation type in  **Settings**. However, you need a role that can access the  **Settings** and the permission to make changes to the operating model.

All assets and complex relations of the same type have the same color and symbol across all diagrams.

References page

The **References** tab page of an asset page contains a table with assets that have [automatic hyperlinks](#) pointing to the current asset.

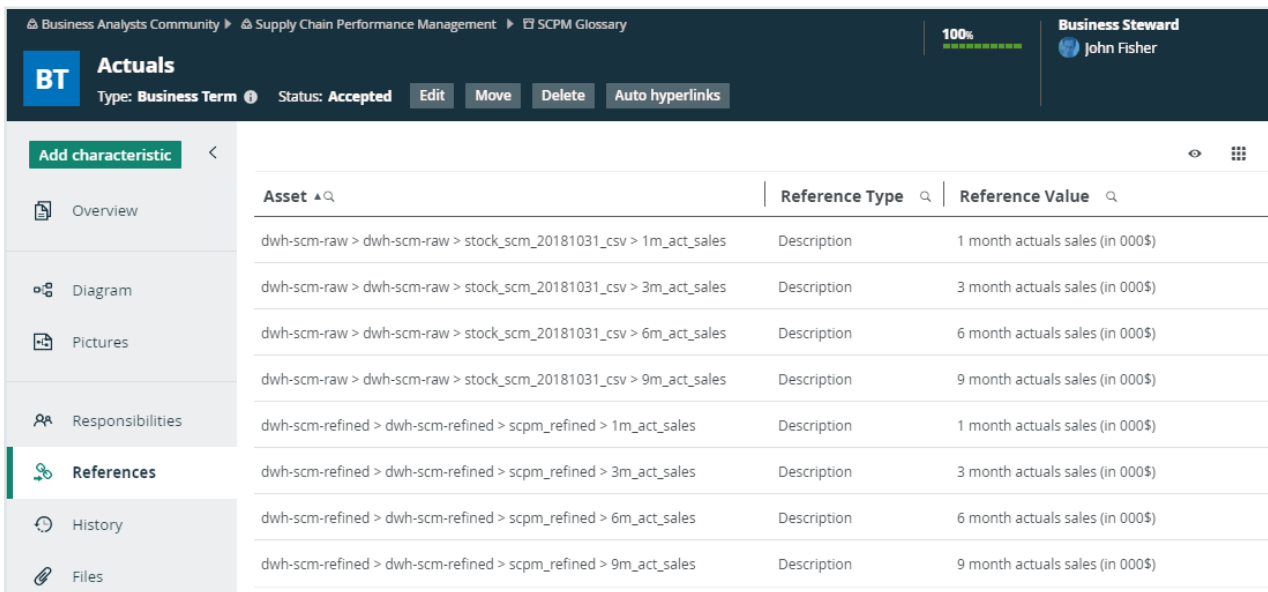

The screenshot shows the 'Actuals' page for a 'Business Term' asset. The page includes a navigation sidebar with options like 'Overview', 'Diagram', 'Pictures', 'Responsibilities', 'References', 'History', and 'Files'. The 'References' tab is active, displaying a table with the following data:

Asset	Reference Type	Reference Value
dwh-scm-raw > dwh-scm-raw > stock_scm_20181031_csv > 1m_act_sales	Description	1 month actuals sales (in 000\$)
dwh-scm-raw > dwh-scm-raw > stock_scm_20181031_csv > 3m_act_sales	Description	3 month actuals sales (in 000\$)
dwh-scm-raw > dwh-scm-raw > stock_scm_20181031_csv > 6m_act_sales	Description	6 month actuals sales (in 000\$)
dwh-scm-raw > dwh-scm-raw > stock_scm_20181031_csv > 9m_act_sales	Description	9 month actuals sales (in 000\$)
dwh-scm-refined > dwh-scm-refined > scpm_refined > 1m_act_sales	Description	1 month actuals sales (in 000\$)
dwh-scm-refined > dwh-scm-refined > scpm_refined > 3m_act_sales	Description	3 month actuals sales (in 000\$)
dwh-scm-refined > dwh-scm-refined > scpm_refined > 6m_act_sales	Description	6 month actuals sales (in 000\$)
dwh-scm-refined > dwh-scm-refined > scpm_refined > 9m_act_sales	Description	9 month actuals sales (in 000\$)

By default, the table shows the **Asset**, the **Reference Type** and **Reference Value** columns. However, you can [add](#) more columns. The following table describes available columns:

Column	Description
Asset	The full name of the asset.

Column	Description
Reference Type	The type of the attribute that contains the automatic hyperlink.
Reference Value	The text of the attribute that contains the automatic hyperlink.
Status	The status of the asset.
Type	The asset type .

Data modeling



In this section, we describe the structure of the Collibra Data Governance Center data model, how data is related and how you can organize your data.



Collibra DGC building blocks

To be able to create a decent data governance model, it is important that you understand the basic building blocks of Collibra Data Governance Center and how they relate to each other.

The following table lists the concepts and explains how Collibra DGC captures information.

Concept	Icon	Description
Community		A community is a grouping of subcommunities and domains. It often corresponds to functional divisions in a company and works best if it is aligned with the company's governance organization.
Domain type	None	A domain type defines the semantics of a domain, as a kind of template. It defines which assets types users can create in the domain.
Domain		<p>A domain is a logical grouping of assets and belongs to exactly one community. It has a domain type that specifies which asset types can be created in the domain.</p> <p>A domain has a unique name within its community.</p> <p>A domain is the instance of exactly one domain type.</p>
Scope	None	<p>A scope is a selection of communities and domains that you can assign to one or more asset types.</p> <p>In a scope, you can define amongst others a domain type, attribute types and relation types.</p>



Concept	Icon	Description
Asset type	None	<p>An asset type defines the semantics of an asset, as a kind of template. It defines which attribute types and relation types the asset can have.</p> <p>Scopes are assigned to asset types.</p>
Asset	Ⓐ	<p>An asset is the fundamental building block or resource for which you want to capture information.</p> <p>An asset belongs to exactly one domain and has a unique name within that domain.</p> <p>An asset is the instance of exactly one asset type.</p>
Attribute type	None	<p>An attribute type defines the class of information that an attribute contains. It is assigned to an asset type through a scope.</p>
Attribute	None	<p>An attribute is a specific piece of information that captures information about an asset. One asset can contain many attributes.</p>
Relation type	None	<p>A relation type specifies the type of relation between two asset types.</p> <p>A relation type is bidirectional, going from a head asset type to a tail asset type and the other way around.</p>
Relation	None	<p>A relation is a link between exactly two assets. It captures how two assets are related to each other. One asset can have many relations.</p> <p>A relation is the instance of exactly one relation type.</p>

Concept	Icon	Description
Complex Relation Type	None	A complex relation type specifies the characteristics of a complex relation instance. A complex relation is a type of relation that helps you to create many-to-many relations, as well as capture attributes (description, priority, ...) on top of the many-to-many relation. They can be regarded as 'objectified associations'. A complex relation type is specified by its name, description, a collection of relation types and a collection of attribute types.

The following diagram explains how the concepts from the table are related to each other.

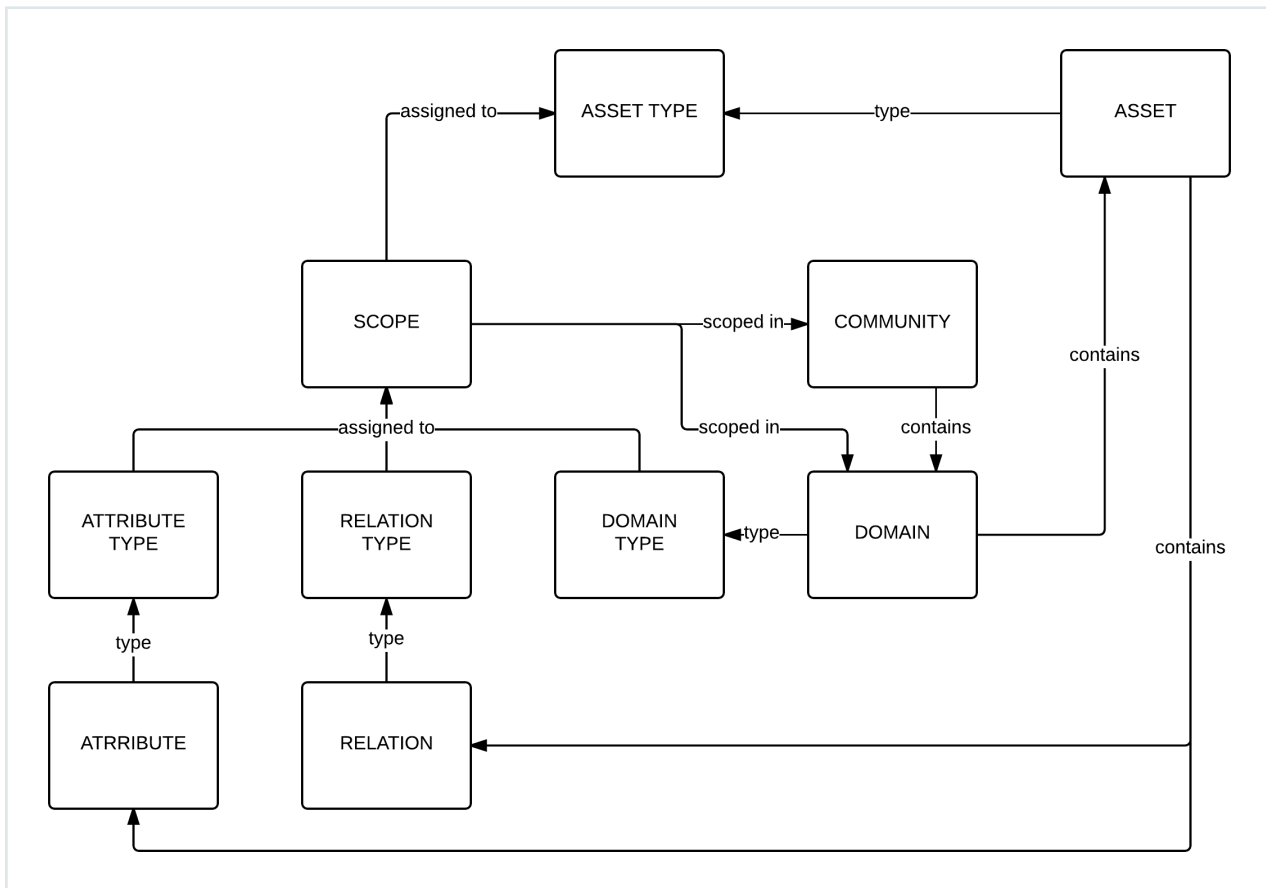

Communities

A community is a grouping of other communities and [domains](#). It often corresponds to functional divisions in a company and works best if it is aligned with the company's governance organization.

Each community can contain any number of subcommunities.

You can recognize a community by the following icon: .

Note

Collibra DGC uses some packaged communities. You can edit them, but you cannot delete them. If required, you can hide them by restricting their [view permissions](#).

Community name	ID	URL
Business Analysts Community	00000000-0000-0000-0001-000100000001	<your environment>/community/00000000-0000-0000-0001-000100000001
Data Governance Council	bc40c085-352c-4a8c-8ee7-494fe821308e	<your environment>/community/bc40c085-352c-4a8c-8ee7-494fe821308e
Schemas	00000000-0000-0000-0001-000100000002	<your environment>/community/00000000-0000-0000-0001-000100000002

Actions

- [Create](#) a community
- Add [domains](#) to a community by [creating](#) a new domain or [moving](#) an existing domain.
- [Create](#) a responsibility to assign a [resource role](#) to a [user](#) or [group](#) for a community.
- [Edit](#) the name of a community.
- [Move](#) a community to another parent community.
- [Delete](#) a community.

Community page overview

The community page provides a complete overview of all information related to a [community](#).

Number	Section	Description
1	Breadcrumbs	The breadcrumbs of the current community.
2	Community representation	The icon or abbreviation of the community.
3	Community name	The name of the community.
4	Resource toolbar	Additional actions, such as editing the community and starting a workflow.
5	Stewards	The stewards of the community. You can see up to three stewards on the community page. If there are more, click See all <number> to see them on the Responsibilities page.
6	Tab pane	A collapsible pane that allows you to navigate to other pages of the community and add characteristics.

Number	Section	Description
7	Editor	<p>The currently selected page, in this case the Overview page, which contains all the attributes that have been defined for the community.</p> <p>The Organization section contains a simple asset view with all the assets in the domains of the community.</p> <div style="border: 1px solid #ccc; padding: 10px; margin-top: 10px;"> <p>Tip If you want to copy and paste text from other sources into a text field, we recommend that you click <code><></code>, and then paste the text into the Show source code field. This will remove any unwanted formatting or tagging of the text. For detailed information, see the knowledge base article on Collibra Support Portal.</p> </div>

Create a community

You can create a new [community](#) at the top level of your organization, or under another community.

Steps

1. In the main menu, click the **Create (+)** button.
 - » The **Create** dialog box appears.
2. Click the **Organization** tab.
3. In the **Community** section, click **Community**.
 - » The **Create Community** dialog box appears.

4. Enter the required information.

Field	Description
Community	The community under which the new communities will be located. If you leave this field empty, the communities will be located at the top level of your organization.
Name	The names of the new communities. <div style="border-left: 2px solid green; padding-left: 10px; margin-top: 10px;"> <p>Tip You can create multiple communities in one go. To do this, press <code>Enter</code> after typing a value and then type the next. Community names have to be globally unique. If you type a name that already exists, it will appear in strike-through style.</p> </div>

5. Click **Create**.

Edit the name of a community

You can edit the name of a [community](#):

- From the community page.
- From an organization table.

Edit the name of a community from the community page



1. Open a community page.
2. In the resource toolbar, click **Edit**.
 - » The **Edit <community name>** dialog box appears.

3. Enter the required information.

Field	Description
Name	The name of the community. Community names have to be globally unique.

4. Click **Save**.

Edit the name of a community from an organization table

1. Open an asset page that contains an organization table, for example a community page.
2. In the **Name** column, do one of the following:
 - Double-click a cell.
 - Hover your mouse over a cell and click .
 » The cell editor appears.
3. Edit the name.
4. Click .

Move a community

You can move a [community](#) to another parent community.

Note Moving a community may impact the [scope](#) to which the community belongs. As a consequence, the [assignment](#) of its assets may change. This determines, for example, which characteristics and statuses the assets can have.

Steps

1. Open a community page.
2. In the resource toolbar, click **Move**.
 - » The **Move <community name>** dialog box appears.

3. Enter the required information.

Field	Description
Community	<p>Enter the name of the new parent community.</p> <p>Community names have to be unique in their parent community. If you try to move this community to a parent community that already contains a community with the same name, an error message will appear after clicking Save.</p>

4. Click **Save**.

Delete a community

You can delete a [community](#).

Warning When you delete a community, you will also delete its contained views, domains and assets.

Steps

1. Open a community page.
2. In the resource toolbar, click **More > Delete**.
 - » The **Delete Confirmation** dialog box appears.
3. Click **Delete <community name>**.

Domains

A domain is a logical grouping of assets. It always has a [domain type](#) and belongs to exactly one [community](#).

You can recognize a domain by the following icon: .

Note

Collibra DGC uses some packaged domains. You can edit them, but you cannot delete them. If required, you can hide them by restricting their [view permissions](#).

Domain name	Domain type	ID	URL
New Data Sets	Data Usage Registry	00000000-0000-0000-0001-000200000001	<your environment>/domain/00000000-0-0000-0000-0001-000200000001
Data Quality Dimensions	Business Asset Domain	00000000-0000-0000-0000-000000006019	<your environment>/domain/00000000-0-0000-0000-0000-000000006019
Issue Classification	Issue Classification	00000000-0000-0000-0000-000000006011	<your environment>/domain/00000000-0-0000-0000-0000-000000006011
New Applications	Technology Asset Domain	00000000-0000-0000-0000-000000006018	<your environment>/domain/00000000-0-0000-0000-0000-000000006018
New Business Terms	Glossary	00000000-0000-0000-0000-000000006013	<your environment>/domain/00000000-0-0000-0000-0000-000000006013
New Data Assets	Data Asset Domain	00000000-0000-0000-0000-000000006015	<your environment>/domain/00000000-0-0000-0000-0000-000000006015

Domain name	Domain type	ID	URL
New Policies & Business Rules	Governance Asset Domain	00000000-0000-0000-0000-000000006016	<your environment>/domain/00000000-0-0000-0000-0000-000000006016
New Processes	Business Asset Domain	00000000-0000-0000-0000-000000006017	domain/00000000-0000-0000-0000-000000006017
New Reference Data	Codelist	00000000-0000-0000-0000-000000006014	<your environment>/domain/00000000-0-0000-0000-0000-000000006014

Actions

- [Create](#) a domain.
- [Edit](#) a domain.
- [Move](#) a domain.
- [Create](#) a responsibility to assign a [resource role](#) to a [user](#) or [group](#) for a community.
- [Delete](#) a domain.

Domain page overview

The domain page provides a complete overview of all information related to a [domain](#).

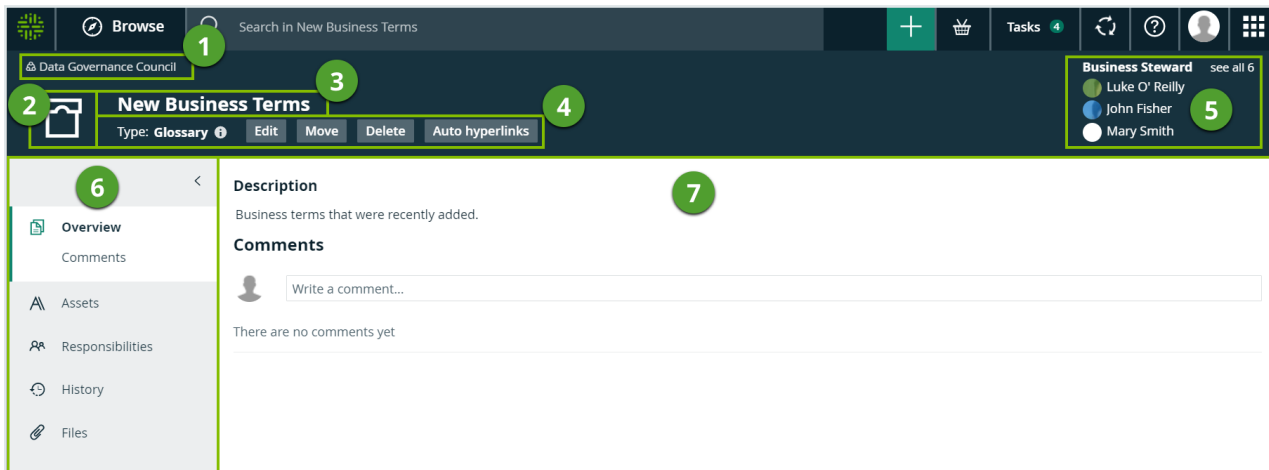

Number	Section	Description
1	Breadcrumbs	The breadcrumbs of the current domain.
2	Domain type representation	The icon or abbreviation of the domain type .
3	Domain name	The name of the domain.
4	Resource menu	Additional actions, such as editing the domain and starting a workflow.
5	Stewards	The stewards of the domain. You can see up to three stewards on the domain page. If there are more, click See all <number> to see them on the Responsibilities page.

Number	Section	Description
6	Tab pane	<p>A collapsible pane that allows you to navigate to other pages of the domain and add characteristics.</p> <ul style="list-style-type: none"> • Overview: Contains the description of and comments about a domain. • Assets: Displays the assets in the domain. • Responsibilities: Displays the view permissions and the responsibilities for a domain. • History: Displays which user has done what with this domain. • Files: Contains attachments.
7	Editor	<p>The currently selected page, in this case the Overview page, which contains all the attributes that have been defined for the domain.</p> <div style="border-left: 2px solid #00a651; padding-left: 10px; margin-top: 10px;"> <p>Tip If you want to copy and paste text from other sources into a text field, we recommend that you click <code><></code>, and then paste the text into the Show source code field. This will remove any unwanted formatting or tagging of the text. For detailed information, see the knowledge base article on Collibra Support Portal.</p> </div>

Create a domain

You can create a new [domain](#) in a [community](#).

Steps

1. In the main menu, click the **Create (+)** button.
 - » The **Create** dialog box appears.
2. Click the **Organization** tab.

3. Click a domain type from the list. To create a Process Register domain, use the **Process Register** domain type.
If you selected the wrong domain type here, you can still change it in the **Type** field in the next screen.
» The **Create Domain** dialog box appears.
4. Enter the required information.

Field	Description
Type	The domain type of the domain you are creating. This field contains the domain type that you clicked in the previous step. You can change it if needed.
Community	The community under which the domain will be located.
Name	The name of the new domain. <div style="border: 1px solid #ccc; padding: 10px; background-color: #f9f9f9;"> <p>Tip You can create multiple domains in one go. To do this, press <code>Enter</code> after typing a value and then type the next. Domain names have to be unique in their parent community. If you type a name that already exists, it will appear in strike-through style.</p> <p>Example</p> <p>The screenshot shows a 'Create' dialog box with three input fields: 'Type' with a dropdown menu showing 'Business Asset Domain', 'Community' with a dropdown menu showing 'Compliance', and 'Name' with a text input field containing 'domain 1' and 'domain_old' (the latter is crossed out). There are 'Back' and 'Create' buttons at the bottom.</p> </div>

5. Click **Create**.

Edit a domain

You can edit the name and **domain type** of a domain:

- From the domain page.
- From an organization table.



Edit a domain from the domain page

1. Open a domain page.
2. In the resource toolbar, click **Edit**.
 - » The **Edit <domain name>** dialog box appears.
3. Enter the required information.

Field	Description
Name	The name of the domain. Domain names have to be unique in their community.
Type	The domain type .

4. Click **Save**.

Edit a domain from an organization table.

1. Open an asset page that contains an organization table, for example, a community page.
2. In the **Name** or **Domain Type** column, do one of the following:
 - Double-click a cell.
 - Hover your mouse over a cell and click .
 - » The cell editor appears.
3. Edit the name or domain type.
4. Click .

Move a domain

You can move a [domain](#) to another [community](#).

Note Moving a domain may impact the [scope](#) to which the domain belongs. As a consequence, the [assignment](#) of its assets may change. This determines, for example, which characteristics and statuses the assets can have.

Steps

1. Open a domain page.
2. In the resource toolbar, click **Move**.
 - » The **Move <domain name>** dialog box appears.
3. Enter the required information.

Field	Description
Community	<p>Enter the name of the new parent community.</p> <p>Domain names have to be unique in the community. If you try to move this domain to a community that already contains a domain with the same name, an error message will appear after clicking Save.</p>

4. Click **Save**.

Delete a domain

You can delete a [domain](#).

Warning When you delete a domain, you will also delete its contained views and assets.

Steps

1. Open a domain page.
2. In the resource toolbar, click **More > Delete**.
 - » The **Delete Confirmation** dialog box appears.
3. Click **Delete <domain name>**.

Asset types

An asset type defines the semantics of an asset, as a kind of template. Via its [assignment](#), it defines which [attribute types](#), [relation types](#) and [statuses](#) the asset can have. It also determines which [articulation rules](#), [data quality rules](#) and [validation rules](#) are applied, and the [domain types](#) in which it can be created.

Some asset types can only be created in a specific Collibra application and in a specific [domain type](#). For example, you can only create assets of the Validation Rule type in a domain of the Validation Rule Domain type. You can see the required domain type in the [assignment](#) of the asset type.



Overview of packaged asset types

An asset type defines the semantics of an asset, as a kind of template. Via its [assignment](#), it defines which [attribute types](#), [relation types](#) and [statuses](#) the asset can have. It also determines which [articulation rules](#), [data quality rules](#) and [validation rules](#) are applied, and the [domain types](#) in which it can be created.

Note If you want to create an asset of a specific type, you need access to one or more domains of the required type. For example, you can only create KPI assets in a Report Catalog domain. As an admin, you can see and edit the required domain types in the assignment.

The table below contains all packaged [asset types](#) and their description.

Tip For an interactive overview of all packaged asset types, including the relevant domain types and applications, see the online version of this guide.

Asset type	Asset type	Description	Required global permission
Business Asset	Business Asset	A type of asset that is exclusively used and governed by the business user community. Its instance assets, and all instances instantiating its subtypes, pertain to the business organization. Business assets typically include business concepts like Business Term, Business Process, Line of Business, etc. that help to build the semantics of any organization with insufficient details to build an actual business application.	Business Semantics Glossary
Business Context	Business Asset ▶ Business Context	A type of asset that binds certain assets by a specific business context. They can be used as filters in Business Context Diagrams.	Business Semantics Glossary

Asset type	Asset type	Description	Required global permission
Business Dimension	Business Asset ▶ Business Dimension	A set of reference information that categorizes and describes business terms in a way that provides context and meaningful answers to business questions. Examples: business process, line of business, region	Data Stewardship Manager
BI Folder	Business Asset ▶ Business Dimension ▶ BI Folder	A collection of BI content	Data Stewardship Manager
Looker Folder	Business Asset ▶ Business Dimension ▶ BI Folder ▶ Looker Folder	A container that stores Looker Looks, Dashboards and other folders.	Data Stewardship Manager

Asset type	Asset type	Description	Required global permission
MicroStrategy Folder	Business Asset ▶ Business Dimension ▶ BI Folder ▶ MicroStrategy Folder	A collection of MicroStrategy reports and data models.	Data Stewardship Manager
MicroStrategy Project	Business Asset ▶ Business Dimension ▶ BI Folder ▶ MicroStrategy Project	A collection of MicroStrategy visualizations, report attributes and tables.	Data Stewardship Manager
Power BI Capacity	Business Asset ▶ Business Dimension ▶ BI Folder ▶ Power BI Capacity	A resource that hosts Power BI Workspaces.	Data Stewardship Manager

Asset type	Asset type	Description	Required global permission
Power BI Folder	Business Asset › Business Dimension › BI Folder › Power BI Folder	A collection of Power BI Report Server Dashboards, Reports and Data Models.	Data Stewardship
Power BI Workspace	Business Asset › Business Dimension › BI Folder › Power BI Workspace	A collection of Power BI Dashboards, Reports and Data Models.	Data Stewardship Manager
SSRS Folder	Business Asset › Business Dimension › BI Folder › SSRS Folder	A collection of SQL Server Reporting Services and Power BI Report Server Reports and Data Sets.	Data Stewardship Manager

Asset type	Asset type	Description	Required global permission
Tableau Project	Business Asset ▶ Business Dimension ▶ BI Folder ▶ Tableau Project	Collection of Tableau workbooks and data sources.	Data Stewardship Manager
Tableau Site	Business Asset ▶ Business Dimension ▶ BI Folder ▶ Tableau Site	Collection of content (workbooks, data sources, users, ...) that's walled off from any other content on that instance of Tableau Server.	Data Stewardship Manager
Business Process	Business Asset ▶ Business Dimension ▶ Business Process	A set of activities and tasks that, once completed, produces value to the business. Examples: campaign management, talent recruitment	Data Stewardship Manager

Asset type	Asset type	Description	Required global permission
Data Category	Business Asset ▶ Business Dimension ▶ Data Category	<p>A container for all the business definitions that encompass associated terminology and definitions that an organization is trying to govern.</p> <p>Examples: master data, reference data, transactional data</p>	Data Stewardship Manager
Data Concept	Business Asset ▶ Business Dimension ▶ Data Concept	<p>A data concept is a high level theoretical representation of the most common data properties of a data domain. A data concept is the business counterpart of a data attribute in a logical data dictionary, just as a data attribute is the logical counterpart of a field or column in the physical data dictionary.</p> <p>(Example: an address is a data concept of the data domain customer or organisation).</p>	Data Stewardship Manager

Asset type	Asset type	Description	Required global permission
Data Domain	Business Asset ▶ Business Dimension ▶ Data Domain	Also known as Data Category or Subject area, this is a container of all the business data domains and data concepts that encompass associated terminology and definitions that an organization is trying to govern. Examples: Master Data (Customer, Product), Reference Data. Business Data Domains group Data Concepts (Year, Date, Address, Name, etc.)	Data Stewardship Manager
Line of Business	Business Asset ▶ Business Dimension ▶ Line of Business	A logical element or segment of an organization that serves a particular business need. Line of business is also known as business unit or business area. Examples: retail, e-commerce, investment management	Data Stewardship Manager

Asset type	Asset type	Description	Required global permission
Business Qualifier	Business Asset ▶ Business Qualifier	Business Qualifiers qualify certain assets. This can be used as filters in Business Qualifier Diagrams.	Business Semantics Glossary
Business Term	Business Asset ▶ Business Term	A word or phrase that describes a concept that is used in a particular branch of business. Examples: customer, person purchase count, loan amount	Business Semantics Glossary
Acronym	Business Asset ▶ Business Term ▶ Acronym	An abbreviation of a business term that forms a word or a name. It is formed by stringing the initial components of a business term together. It is often pronounced as a word. Examples: ERP, EDW, EAD	Business Semantics Glossary

Asset type	Asset type	Description	Required global permission
Measure	Business Asset ▶ Measure	<p>An asset type that is used for calculations, such as sum, count, average, minimum or maximum.</p> <p>Examples: net sales, top customers, on-hand inventory</p>	Business Semantics Glossary
KPI	Business Asset ▶ Measure ▶ KPI	<p>Key Performance Indicator, an indicator to periodically measure the success of or the progress towards a strategic goal of a particular activity or of an organization.</p> <p>Examples: employee turnover, customer attrition, claims denial rate</p>	Business Semantics Glossary

Asset type	Asset type	Description	Required global permission
Report	Business Asset › Report	<p>A document containing information that is organized in a narrative, graphic, or tabular form. The document is prepared on an ad hoc, periodic, recurring, regular or as-required basis.</p> <p>Reports can refer to specific periods, events, occurrences or subjects.</p>	Business Semantics Glossary
BI Report	Business Asset › Report › BI Report	A visual representation of data or a collection of visualizations.	Business Semantics Glossary
Looker Dashboard	Business Asset › Report › BI Report › Looker Dashboard	A collection of Looker tiles with metrics from one or more Looker Looks.	Business Semantics Glossary

Asset type	Asset type	Description	Required global permission
Looker Look	Business Asset › Report › BI Report › Looker Look	A detailed view of a Looker Data Set, with visualizations of findings and insights.	Business Semantics Glossary
Looker Query	Business Asset › Report › BI Report › Looker Query	A query that creates a simple report in a Looker Tile or Looker Look.	Business Semantics Glossary
Looker Tile	Business Asset › Report › BI Report › Looker Tile	An element that represents data on the Looker Dashboard.	Business Semantics Glossary
MicroStrategy Dossier	Business Asset › Report › BI Report › MicroStrategy Dossier	A collection of MicroStrategy chapters and pages.	Business Semantics Glossary

Asset type	Asset type	Description	Required global permission
MicroStrategy Report	Business Asset › Report › BI Report › MicroStrategy Report	A detailed view of a MicroStrategy data model, with visualizations of findings and insights.	Business Semantics Glossary
Power BI Dashboard	Business Asset › Report › BI Report › Power BI Dashboard	A collection of Power BI tiles with metrics from one or more Reports and Data Models.	Business Semantics Glossary
Power BI KPI	Business Asset › Report › BI Report › Power BI KPI	A key performance indicator of Power BI Report Server.	Business Semantics Glossary
Power BI Report	Business Asset › Report › BI Report › Power BI Report	A detailed view of a Power BI Data Model, with visualizations of findings and insights.	Business Semantics Glossary

Asset type	Asset type	Description	Required global permission
Power BI Tile	Business Asset › Report › BI Report › Power BI Tile	An element representing data on the Power BI Dashboard.	Business Semantics Glossary
SSRS KPI	Business Asset › Report › BI Report › SSRS KPI	A key performance indicator of SQL Server Reporting Services.	Business Semantics Glossary
SSRS Report	Business Asset › Report › BI Report › SSRS Report	A detailed view of an SQL Server Reporting Services Data Set, with visualizations of findings and insights.	Business Semantics Glossary
Tableau Dashboard	Business Asset › Report › BI Report › Tableau View › Tableau Dashboard	A collection of several worksheets and supporting information, shown on a single screen, so that you can simultaneously compare and monitor a variety of data.	Business Semantics Glossary

Asset type	Asset type	Description	Required global permission
Tableau Worksheet	Business Asset › Report › BI Report › Tableau View › Tableau Worksheet	A worksheet is a single sheet on which you can build views of your data.	Business Semantics Glossary
Tableau Workbook	Business Asset › Report › BI Report › Tableau Workbook	Collection of sheets. A sheet can be a worksheet, a dashboard or a story.	Business Semantics Glossary

Asset type	Asset type	Description	Required global permission
Data Asset	Data Asset	A type of asset that represents details of organizational data in two layers. One layer is independent of any particular technology for non-technical stakeholder communication. The other one is taking the implementation system for technical stakeholder communication into account. Examples: Data Element, Table	<ul style="list-style-type: none"> • Catalog • Data Dictionary
Code Set	Data Asset ▶ Code Set	An enumerated list of valid code values for a specific topic, where the code set is the whole and the code values are parts of that whole. It is a data asset that defines the set of permissible values to be used by other data assets. Examples: Product Code Set, Person Gender Code, ISO 3166 Country Code	Reference Data Manager

Asset type	Asset type	Description	Required global permission
Code Value	Data Asset ▸ Code Value	A valid form of representation for an asset, shortened or covert. Examples: <ul style="list-style-type: none">• In the Person Gender Code, “male”, “female”, “not known” and “not specified” are represented by the valid code values “1”, “2”, “0” and “9”.• “US” is part of the “ISO 3166 code set” and refers to The United States of America.	Reference Data Manager
Crosswalk	Data Asset ▸ Crosswalk	Mapping between two or more code sets.	<ul style="list-style-type: none"> • Catalog • Data Dictionary
Data Element	Data Asset ▸ Data Element	A construct that documents aspects of something abstract, especially one that is essential for business. Examples: person birth date, person address	<ul style="list-style-type: none"> • Catalog • Data Dictionary

Asset type	Asset type	Description	Required global permission
Column	Data Asset ▸ Data Element ▸ Column	An atomic unit of data that can be stored in a database table. Examples: FST_NM, EMPID	<ul style="list-style-type: none"> • Catalog • Data Dictionary
Data Attribute	Data Asset ▸ Data Element ▸ Data Attribute	A specification that defines a property of a data entity. Examples: CustomerBirthDate, EmployeeFirstName	<ul style="list-style-type: none"> • Catalog • Data Dictionary
BI Data Attribute	Data Asset ▸ Data Element ▸ Data Attribute ▸ BI Data Attribute	An atomic unit of data that represents a BI report.	<ul style="list-style-type: none"> • Catalog • Data Dictionary

Asset type	Asset type	Description	Required global permission
Looker Data Set Column	Data Asset ▶ Data Element ▶ Data Attribute ▶ BI Data Attribute ▶ Looker Data Set Column	An atomic unit of data that is used in a Looker Look or Looker Tile. It represents a column in a Looker Data Set.	<ul style="list-style-type: none"> • Catalog • Data Dictionary
MicroStrategy Column	Data Asset ▶ Data Element ▶ Data Attribute ▶ BI Data Attribute ▶ MicroStrategy Column	A column in a MicroStrategy data model.	<ul style="list-style-type: none"> • Catalog • Data Dictionary

Asset type	Asset type	Description	Required global permission
Power BI Column	Data Asset <ul style="list-style-type: none"> ▸ Data Element ▸ Data Attribute ▸ BI Data Attribute ▸ Power BI Column 	A column in a Power BI Data Model.	<ul style="list-style-type: none"> • Catalog • Data Dictionary
SSRS Column	Data Asset <ul style="list-style-type: none"> ▸ Data Element ▸ Data Attribute ▸ BI Data Attribute ▸ SSRS Column 	A column in an SQL Server Reporting Services Report Data Set.	<ul style="list-style-type: none"> • Catalog • Data Dictionary

Asset type	Asset type	Description	Required global permission
Tableau Data Attribute	Data Asset ▸ Data Element ▸ Data Attribute ▸ BI Data Attribute ▸ Tableau Data Attribute	A specification that defines a property of a Tableau data entity. Examples: CustomerBirthDate, EmployeeFirstName.	<ul style="list-style-type: none"> • Catalog • Data Dictionary
Field	Data Asset ▸ Data Element ▸ Field	An atomic unit of data that can be stored in a file. Examples: FirstName, EmpID	<ul style="list-style-type: none"> • Catalog • Data Dictionary
Report Attribute	Data Asset ▸ Data Element ▸ Report Attribute	An atomic unit of data that represents a report.	<ul style="list-style-type: none"> • Catalog • Data Dictionary
BI Report Attribute	Data Asset ▸ Data Element ▸ Report Attribute ▸ BI Report Attribute	An atomic unit of data that represents a BI report.	<ul style="list-style-type: none"> • Catalog • Data Dictionary

Asset type	Asset type	Description	Required global permission
Looker Report Attribute	Data Asset <ul style="list-style-type: none"> ▸ Data Element ▸ Report Attribute ▸ BI Report Attribute ▸ Looker Report Attribute 	An atomic unit of data that is used in a Looker Look or Looker Tile. It represents the actual use a Looker Data Set Column.	<ul style="list-style-type: none"> • Catalog • Data Dictionary
MicroStrategy Report Attribute	Data Asset <ul style="list-style-type: none"> ▸ Data Element ▸ Report Attribute ▸ BI Report Attribute ▸ MicroStrategy Report Attribute 	A detailed view of a MicroStrategy visualization, with findings and insights.	<ul style="list-style-type: none"> • Catalog • Data Dictionary

Asset type	Asset type	Description	Required global permission
Power BI Parameter	Data Asset ▶ Data Element ▶ Report Attribute ▶ BI Report Attribute ▶ Power BI Parameter	A column that is part of a Power BI Report Server Data Model and that is used in a KPI.	<ul style="list-style-type: none"> • Catalog • Data Dictionary
SSRS Parameter	Data Asset ▶ Data Element ▶ Report Attribute ▶ BI Report Attribute ▶ SSRS Parameter	A column that is part of an SQL Server Reporting Services Data Set and that is used in a KPI.	<ul style="list-style-type: none"> • Catalog • Data Dictionary

Asset type	Asset type	Description	Required global permission
Tableau Report Attribute	Data Asset ▸ Data Element ▸ Report Attribute ▸ BI Report Attribute ▸ Tableau Report Attribute	An atomic unit of data that represents a Tableau report. Examples: ExpenseAmount, RiskAmount	<ul style="list-style-type: none"> • Catalog • Data Dictionary
Data Set	Data Asset ▸ Data Set	A collection of related sets of data assets that are data elements or composed of data elements. Example: Customer Contact information	<ul style="list-style-type: none"> • Catalog • Data Dictionary
BI Data Set	Data Asset ▸ Data Set ▸ BI Data Set	A collection of data that is used for BI report creation	<ul style="list-style-type: none"> • Catalog • Data Dictionary
Looker Data Set	Data Asset ▸ Data Set ▸ BI Data Set ▸ Looker Data Set	A collection of data that is used to define Looker Dimensions and Measures.	<ul style="list-style-type: none"> • Catalog • Data Dictionary

Asset type	Asset type	Description	Required global permission
SSRS Data Model	Data Asset ▶ Data Set ▶ BI Data Set ▶ SSRS Data Model	A collection of data that is used to create an SQL Server Reporting Services Report.	<ul style="list-style-type: none"> • Catalog • Data Dictionary
Data structure	Data Asset ▶ Data structure	A logical grouping (through whole-part relation) of data elements. Example: cfPerson is a data structure that contains the cfBirthDate, cfPersonFullName data elements.	<ul style="list-style-type: none"> • Catalog • Data Dictionary
Data Entity	Data Asset ▶ Data Structure ▶ Data Entity	A unit of data that can be classified and can have a stated relationship to other units of data. Examples: Customer, Employee	<ul style="list-style-type: none"> • Catalog • Data Dictionary

Asset type	Asset type	Description	Required global permission
BI Data Entity	Data Asset ▸ Data Structure ▸ Data Entity ▸ BI Data Entity	A unit of data in a BI data source that can be classified and can have a stated relationship to other units of data.	<ul style="list-style-type: none"> • Catalog • Data Dictionary
Power BI Table	Data Asset ▸ Data Structure ▸ Data Entity ▸ BI Data Entity ▸ Power BI Table	A table in a Power BI Data Model.	<ul style="list-style-type: none"> • Catalog • Data Dictionary
SSRS Table	Data Asset ▸ Data Element ▸ Data Attribute ▸ BI Data Attribute ▸ Power BI Table ▸ SSRS Table	A table in an SQL Server Reporting Services Report Data Set.	<ul style="list-style-type: none"> • Catalog • Data Dictionary

Asset type	Asset type	Description	Required global permission
Tableau Data Entity	Data Asset ▸ Data Structure ▸ Data Entity ▸ BI Data Entity ▸ Tableau Data Entity	An abstraction from the physical implementation of database tables, used for Tableau report creation.	<ul style="list-style-type: none"> • Catalog • Data Dictionary
Data Model	Data Asset ▸ Data Structure ▸ Data Model	<p>Organizes data elements and standardizes how the data elements relate to one another. The data model often facilitates the communication between business and technology.</p> <p>Examples: customer subject area model, event subject area model</p>	<ul style="list-style-type: none"> • Catalog • Data Dictionary

Asset type	Asset type	Description	Required global permission
BI Data Model	Data Asset ▶ Data Structure ▶ Data Model ▶ BI Data Model	<p>A diagram that organizes data elements and standardizes how the data elements relate to one another. The Data Model is often used as a communication aid between business and technology.</p> <p>Examples: Customer Subject area model, Event Subject area model</p>	<ul style="list-style-type: none"> • Catalog • Data Dictionary
MicroStrategy Data Model	Data Asset ▶ Data Structure ▶ Data Model ▶ BI Data Model ▶ MicroStrategy Data Model	<p>A collection of data that is used to create MicroStrategy reports.</p>	<ul style="list-style-type: none"> • Catalog • Data Dictionary

Asset type	Asset type	Description	Required global permission
Power BI Data Flow	Data Asset ▸ Data Structure ▸ Data Model ▸ BI Data Model ▸ Power BI Data Flow	A collection of tables that are created and managed in workspaces in the Power BI service.	<ul style="list-style-type: none"> • Catalog • Data Dictionary
Power BI Data Model	Data Asset ▸ Data Structure ▸ Data Model ▸ BI Data Model ▸ Power BI Data Model	A collection of data that is used to create a Power BI report.	<ul style="list-style-type: none"> • Catalog • Data Dictionary
Tableau Data Model	Data Asset ▸ Data Structure ▸ Data Model ▸ BI Data Model ▸ Tableau Data Model	An abstraction from the physical implementation of database, schema, file, etc., used for Tableau report creation.	<ul style="list-style-type: none"> • Catalog • Data Dictionary

Asset type	Asset type	Description	Required global permission
Schema	Data Asset ▸ Data Structure ▸ Schema	An asset that contains the location of specific data. It provides all the details that are required for setting up a connection to a database or server.	<ul style="list-style-type: none"> • Catalog • Data Dictionary
Table	Data Asset ▸ Data Structure ▸ Table	An implementation of data entities in columns and rows, in a given database system. It is the basic structure of a relational database. Examples: Account_tbl, CUST_ADDR	<ul style="list-style-type: none"> • Catalog • Data Dictionary
Database View	Data Asset ▸ Data Structure ▸ Table ▸ Database View	A Database View is a virtual table based on the result-set of an SQL statement.	<ul style="list-style-type: none"> • Catalog • Data Dictionary

Asset type	Asset type	Description	Required global permission
Data Usage	Data Asset ▸ Data Usage	An asset that clearly documents how the data can be used between data producers and consumers for specific purpose Example: Sales growth information that is available to share for read-only requirements	<ul style="list-style-type: none"> • Catalog • Data Dictionary
Foreign Key	Data Asset ▸ Foreign Key	Asset type used to model the Primary key - Foreign key relations in relational databases.	<ul style="list-style-type: none"> • Catalog • Data Dictionary
Mapping Specification	Data Asset ▸ Mapping Specification	Mapping between two or more data structures.	<ul style="list-style-type: none"> • Catalog • Data Dictionary

Asset type	Asset type	Description	Required global permission
Governance Asset	Governance Asset	A type of asset that is used to monitor and advocates to maximize performance or utilization of other Business and Data assets while minimizing the risk factors in alignment with Organisational/Business goals.	Policy Manager
Assessment Review	Governance Asset ▶ Assessment Review	An asset of this type is created when an assessment is conducted on an asset and submitted for review.	Policy Manager
Data Quality Dimension	Governance Asset ▶ Data Quality Dimension	Represents criteria that are relevant for assessing quality and categorizes different aspects of how data quality is measured. Examples: accuracy, completeness, consistency	Data Helpdesk

Asset type	Asset type	Description	Required global permission
Data Sharing Agreement	Governance Asset ▶ Data Sharing Agreement	An agreement between data producers and consumers with terms and conditions including provisions concerning access and dissemination to 'pool' a set of data for specific purposes. Examples: Sales growth information that is available only to the Risk team for generating internal reports.	Policy Manager
Issue Category	Governance Asset ▶ Issue Category		Data Helpdesk
Policy	Governance Asset ▶ Policy	A statement of intent that is set by a council and is implemented by a set of standards. Example: Personal information must be adequately protected.	Policy Manager

Asset type	Asset type	Description	Required global permission
Standard	Governance Asset ▶ Policy ▶ Standard	<p>Consists of specific low-level mandatory controls that help enforce and support the policy.</p> <p>Example: All personal information is encrypted with a specific encryption type.</p>	Policy Manager
Rule	Governance Asset ▶ Rule	<p>Defines or constrains some aspect of specific business data categories. It is intended to control or influence the behavior of the business.</p> <p>Example: Every customer must have a unique identifier.</p>	Policy Manager
Business Rule	Governance Asset ▶ Rule ▶ Business Rule	<p>Defines or constrains some aspect of specific business data. It is intended to control or influence the behavior of business data.</p> <p>Example: Customer numbers have to be unique.</p>	Policy Manager

Asset type	Asset type	Description	Required global permission
Data Quality Metric	Governance Asset ▶ Rule ▶ Data Quality Metric	<p>An implementation of data quality rules in a selected physical database system using a particular data quality tool.</p> <p>Example: CRM.ACT.Tx_ID cannot be null, must be a 9-digit number and has to take the 999-99-9999 format in the CRM system, and ERP.Cust.SSN has to take the 999999999 format in the ERP system.</p>	Data Helpdesk
Data Quality Rule	Governance Asset ▶ Rule ▶ Data Quality Rule	<p>A specification that defines which actions are required to measure the quality level of a data element for its intended use.</p> <p>Example: SSN must be a unique 9-digit identification number for 100% of US personal accounts for tax processing.</p>	Data Helpdesk

Asset type	Asset type	Description	Required global permission
Validation Rule	Governance Asset ▶ Rule ▶ Validation Rule	A rule that describes a criterion to which content in DGC has to comply.	Reference Data Manager
Issue	Issue	The parent asset type of all issues.	Data Helpdesk
Data Issue	Issue ▶ Data Issue	A problem related to issue management, also referred to as "issue".	Data Helpdesk
Technology Asset	Technology Asset	A piece of information technology (hardware, software, database, software platform) that helps an organization to run a business application. Examples: Database, File	<ul style="list-style-type: none"> • Catalog • Data Dictionary
Database	Technology Asset ▶ Database	A collection of data that is systematically organized or structured, to make it is easy to create, update and query the information. Examples: Ora_DGC_V45, SalesDB2020	<ul style="list-style-type: none"> • Catalog • Data Dictionary

Asset type	Asset type	Description	Required global permission
File Container	Technology Asset › File Container	An asset type that represents Cloud File Container.	<ul style="list-style-type: none"> • Catalog • Data Dictionary
Directory	Technology Asset › File Container › Directory	<p>A collection of data that is treated by a computer as a unit, for the purposes of input and output.</p> <p>Examples: businessGlossary.xls, dataDictionary05220.csv, datacatalogv25.txt</p>	<ul style="list-style-type: none"> • Catalog • Data Dictionary
GCS Bucket	Technology Asset › File Container › GCS Bucket	An asset type that represents an Google Cloud Storage bucket which is a logical unit of storage containing Google Cloud Storage objects.	<ul style="list-style-type: none"> • Catalog • Data Dictionary
S3 Bucket	Technology Asset › File Container › S3 Bucket	An asset type that represents an Amazon S3 Bucket, which is a logical unit of storage containing Amazon S3 Objects.	<ul style="list-style-type: none"> • Catalog • Data Dictionary

Asset type	Asset type	Description	Required global permission
File Group	Technology Asset ▶ File Group	A collection of physical files which together represent a single logical file.	<ul style="list-style-type: none"> • Catalog • Data Dictionary
Server	Technology Asset ▶ Server	A computer program or device that supports other computer programs and their users	<ul style="list-style-type: none"> • Catalog • Data Dictionary
BI Server	Technology Asset ▶ Server ▶ BI Server	A visual analytics platform for creating and storing visualizations.	<ul style="list-style-type: none"> • Catalog • Data Dictionary
Looker Tenant	Technology Asset ▶ Server ▶ BI Server ▶ Looker Tenant	A platform to create Looker Dashboards and rich visualizations.	<ul style="list-style-type: none"> • Catalog • Data Dictionary
MicroStrategy Server	Technology Asset ▶ Server ▶ BI Server ▶ MicroStrategy Server	A visual analytics platform for creating and storing MicroStrategy reports and data models.	<ul style="list-style-type: none"> • Catalog • Data Dictionary

Asset type	Asset type	Description	Required global permission
Power BI Server	Technology Asset › Server › BI Server › Power BI Server	A visual analytics platform for creating and storing Power BI Reports and Data Models.	<ul style="list-style-type: none"> • Catalog • Data Dictionary
SSRS Server	Technology Asset › Server › BI Server › SSRS Server	A visual analytics platform for creating and storing SQL Server Reporting Services and Power BI Report Server Reports and Data Sets.	<ul style="list-style-type: none"> • Catalog • Data Dictionary
Tableau Server	Technology Asset › Server › BI Server › Tableau Server	A visual analytics platform for creating interactive dashboards and rich visualisations	<ul style="list-style-type: none"> • Catalog • Data Dictionary

Asset type	Asset type	Description	Required global permission
System	Technology Asset ▸ System	<p>Executable software that you can buy commercially off the shelf (COTS), or build internally, to automate one or more business functions that help run a business smoothly and efficiently.</p> <p>Examples: CRM, ERP, EDW</p>	<ul style="list-style-type: none"> • Catalog • Data Dictionary
BI Data Source	Technology Asset ▸ System ▸ BI Data Source	The link between a BI System and an external system.	<ul style="list-style-type: none"> • Catalog • Data Dictionary
Tableau Data Source	Technology Asset ▸ System ▸ BI Data Source ▸ Tableau Data Source	The link between Tableau and an external system. A Tableau data source contains the information to connect to external data, table names, the table relationships, and any customizations that you make.	<ul style="list-style-type: none"> • Catalog • Data Dictionary

Asset type	Asset type	Description	Required global permission
File Storage	Technology Asset ▶ System ▶ File Storage	An asset type that represents a Cloud File Storage bucket.	<ul style="list-style-type: none"> • Catalog • Data Dictionary
GCS File System	Technology Asset ▶ System ▶ File Storage ▶ GCS File System	An asset type that represents Google Cloud Storage file system.	<ul style="list-style-type: none"> • Catalog • Data Dictionary
S3 File System	Technology Asset ▶ System ▶ File Storage ▶ S3 File System	Amazon S3 (Simple Storage Service) file system abstraction.	<ul style="list-style-type: none"> • Catalog • Data Dictionary



Create an asset type

You can create an [asset type](#). For example, you can do this if the packaged asset types do not suffice.

Prerequisites

You have a [global role](#) that has the System administration [global permission](#).

Steps

1. In the main menu, click , then  **Settings**.
 - » The [Collibra DGC settings page](#) opens.
2. Click **Operating Model**.
 - » The [operating model settings](#) appear on the **Asset types** tab page.
3. Above the table, to the right, click **Add**.
 - » The **Asset Type Creation** dialog box appears.
4. Enter the required information.

Field	Description
Name	The name of the asset type. You can add more than one type by pressing <code>Enter</code> .
Parent Asset Type	The parent asset type from which the new asset type inherits all properties.

5. Click **Save**.

Warning If you create an asset type and hierarchically nest the new asset type under, for example, a Catalog asset type, you may encounter asset page rendering issues. This is due to a difference in the required characteristics of the asset type you created and the Catalog asset type. Likewise, if you remove a required characteristic from an asset type, you may encounter page rendering issues for asset pages of that asset type.

What's next?

If necessary, [edit](#) the asset type, for example by doing one of the following:

- [Enable or disable](#) ratings and reviews.
- [Enable or disable](#) non-unique naming.
- [Edit](#) the representation in Collibra Data Governance Center.



Edit an asset type

You can edit an [asset type](#). For example you can do this if you want to give it another name.

Prerequisites

You have a [global role](#) that has the System administration [global permission](#).

Steps

1. Open an asset type.
 - a. In the main menu, click , then  **Settings**.
 - » The [Collibra DGC settings page](#) opens.
 - b. Click **Operating Model**.
 - » The [operating model settings](#) appear on the **Asset types** tab page.
 - c. In the overview of asset types, click an asset type.
 - » The **Asset type** editor opens.
2. In the upper-right corner, click **Edit**.
 - » The **Edit <asset type>** dialog box appears.
3. Enter the required information.

Field	Description
Name	Enter the name of the asset type.
Allow identical asset names per domain	Select to enable identical asset names per domain . Clear to disable identical asset names per domain.
Enable ratings	Select to allow users to rate assets. Ratings enable users to subjectively rate the quality of an asset, using a five-star rating system, and write a free-text review of the asset, in support of the rating provided.

Field	Description
Display options	These fields allow you to edit how assets of this type are represented on the asset page and in diagrams .
Colors	The default colors that you can use for the complex relation nodes of this type.
Color hex value	The hexadecimal value of the color that you want for assets of this type. For a list of colors and their hexadecimal values, see ColorHexa .
Symbol	A graphical representation for assets of this type. You can choose one of the following values: <ul style="list-style-type: none"> ◦ None: No graphical representation is used for assets of this type. ◦ Code: Assets of this type are represented with a code in front of them. You can specify the code that you want in the Code field. ◦ Icon: Assets of this type are represented with an icon in front of them. You can select the icon that you want in the Icon reference field.
Code	The code that is displayed in front of assets of this type. This code is also displayed in the legend of diagrams. By default, this field contains the initials of the selected asset type. This field is only displayed if you have selected Code in the Symbol field.

Field	Description
Icon reference	<p>The icon that is displayed in front of assets of this type. This icon is also displayed in the legend of diagrams.</p> <p>This field is only displayed if you have selected Icon in the Symbol field.</p>
Preview	<p>Displays two previews of your asset type configuration.</p> <ul style="list-style-type: none"> ◦ The left preview is the title bar on an asset page. ◦ The right preview is a diagram node.

4. Click **Save**.



Edit an asset type's representation

You can change the color and icon by which an asset is represented in Collibra Data Governance Center. This can be handy to quickly spot a specific [asset type](#) in a diagram.

Prerequisites

You have a [global role](#) that has the System administration [global permission](#).

Steps

1. Open an asset type.
 - a. In the main menu, click , then  **Settings**.
 - » The [Collibra DGC settings page](#) opens.
 - b. Click **Operating Model**.
 - » The [operating model settings](#) appear on the **Asset types** tab page.
 - c. In the overview of asset types, click an asset type.
 - » The **Asset type** editor opens.
2. In the upper-right corner, click **Edit**.

- » The **Edit <asset type>** dialog box appears.
3. Enter the required information.

Field	Description
Display options	These fields allow you to edit how assets of this type are represented on the asset page and in diagrams .
Colors	The default colors that you can use for the complex relation nodes of this type.
Color hex value	The hexadecimal value of the color that you want for assets of this type. For a list of colors and their hexadecimal values, see ColorHexa .
Symbol	A graphical representation for assets of this type. You can choose one of the following values: <ul style="list-style-type: none"> ◦ None: No graphical representation is used for assets of this type. ◦ Code: Assets of this type are represented with a code in front of them. You can specify the code that you want in the Code field. ◦ Icon: Assets of this type are represented with an icon in front of them. You can select the icon that you want in the Icon reference field.
Code	The code that is displayed in front of assets of this type. This code is also displayed in the legend of diagrams. By default, this field contains the initials of the selected asset type. This field is only displayed if you have selected Code in the Symbol field.

Field	Description
Icon reference	<p>The icon that is displayed in front of assets of this type. This icon is also displayed in the legend of diagrams.</p> <p>This field is only displayed if you have selected Icon in the Symbol field.</p>
Preview	<p>Displays two previews of your asset type configuration.</p> <ul style="list-style-type: none"> ◦ The left preview is the title bar on an asset page. ◦ The right preview is a diagram node.

4. Click **Save**.

Enable or disable ratings

You can enable and disable [ratings](#) via the [asset type](#) pages, in  **Settings**.

Enabling ratings for a particular asset type is not inherited by children asset types. The feature has to be manually enabled for each child asset type.



By default, ratings are enabled for asset types **Data Set** and **Report** and their children asset types. Ratings are disabled, by default, for all other packaged asset types and any asset types you create.

Warning Ratings cannot be disabled for a specific asset type if user ratings exist for any assets of that asset type. In other words, all user ratings for all assets of a specific asset type must be manually [deleted](#) before ratings can be disabled for that asset type.

Prerequisites

You have a [global role](#) that has the System administration [global permission](#).

Steps

1. Open an asset type.
 - a. In the main menu, click , then  **Settings**.
 - » The [Collibra DGC settings page](#) opens.
 - b. Click **Operating Model**.
 - » The [operating model settings](#) appear on the **Asset types** tab page.
 - c. In the overview of asset types, click an asset type.
 - » The **Asset type** editor opens.
2. In the upper-right corner, click **Edit**.
 - » The **Edit <asset type>** dialog box appears.
3. Enter the required information.

Field	Description
Enable ratings	Select to allow users to rate assets. Ratings enable users to subjectively rate the quality of an asset, using a five-star rating system, and write a free-text review of the asset, in support of the rating provided.

4. Click **Save**.



Enable or disable identical asset names per domain

You can enable and disable [Identical asset names per domain](#), by [asset type](#).

Prerequisites

You have a new or existing asset type.

Steps

1. Open an asset type.
 - a. In the main menu, click , then  **Settings**.
 - » The [Collibra DGC settings page](#) opens.

- b. Click **Operating Model**.
 - » The [operating model settings](#) appear on the **Asset types** tab page.
- c. In the overview of asset types, click an asset type.
 - » The **Asset type** editor opens.
2. In the upper-right corner, click **Edit**.
 - » The **Edit <asset type>** dialog box appears.
3. Enter the required information.

Field	Description
Allow identical asset names per domain	Select to enable identical asset names per domain . Clear to disable identical asset names per domain.

4. Click **Save**.



Move an asset type

You can move an [asset type](#) to another parent asset type. As a consequence, the asset type may inherit the assignment of the new asset type, which may impact, amongst others, the possible characteristics.

Prerequisites

You have a [global role](#) that has the System administration [global permission](#).

Move an asset type from the asset type table



1. In the main menu, click , then  **Settings**.
 - » The [Collibra DGC settings page](#) opens.
2. Click **Operating Model**.
 - » The [operating model settings](#) appear on the **Asset types** tab page.
3. In the row of the asset type that you want to move, click .
 - » The **Select Parent Asset Type** dialog box appears.

- Enter the required information.

Field	Description
Parent	Choose the parent asset type.

- Click **Save**.

Move an asset type from the asset type page

- Open an asset type.
 - In the main menu, click , then  **Settings**.
 - » The [Collibra DGC settings page](#) opens.
 - Click **Operating Model**.
 - » The [operating model settings](#) appear on the **Asset types** tab page.
 - In the overview of asset types, click an asset type.
 - » The **Asset type** editor opens.
- Above the table, to the right, click **Move**.
 - » The **Select Parent Asset Type** dialog box appears.
- Enter the required information.

Field	Description
Parent	Choose the parent asset type.

- Click **Save**.



Delete an asset type

You can delete an [asset type](#). For example, you can do this if you no longer need an asset type that you created earlier.

Prerequisites

- You have a [global role](#) that has the System administration [global permission](#).
- It is not a packaged asset type.
- There are no assets of that asset type. If assets of that asset type exist, either [edit](#) their asset type or [delete](#) them.

Steps

1. In the main menu, click , then  **Settings**.
 - » The [Collibra DGC settings page](#) opens.
2. Click **Operating Model**.
 - » The [operating model settings](#) appear on the **Asset types** tab page.
3. In the row of the asset type that you want to delete, click  .
 - » The **Delete Asset Type** dialog box appears.
4. Click **Yes**.

Assignments

An assignment is a collection of components that is assigned to an asset type and optionally to its child asset types.

In this section, we provide more information about the assignments in Collibra Data Governance Center.



Assignments

An assignment is a collection of components that is assigned to an asset type and optionally to its child asset types.

Assignments determine what you can do with assets in the user interface of Collibra Data Governance Center, but they do not limit the possibilities of the [API](#) or [import feature](#).

Assignments and scopes

An assignment can apply globally, in which case it is called the global assignment, or to a [scope](#), in which case it is called a scoped assignment.

The global assignment applies to all assets that are not in a scope. A scoped assignment only applies to assets that are located in a domain or community that belongs to the scope. An asset type can only have one global scope, but many scoped assignments.

An asset type can only have scoped assignments if it has a global assignment.

Components

The following components can be assigned to an asset type.

Characteristics

The **Characteristics** page contains a list of all attribute types, relation types and complex relation types that can be added to an asset of this type, if the asset is in the scope of the assignment.

An assignment line consists of the following:

- One [characteristic type](#), including its description and kind.
- A minimum cardinality.
- A maximum cardinality.

The cardinality of an assignment line determines how many characteristics of this type can be added to an asset.

Number	Minimum	Maximum
not filled in	This is not possible. The minimum number of occurrences must at least be 0.	You can add as many characteristics of this characteristic type as you want.
0	The characteristic doesn't automatically appear on the asset page, but you can add it via Add characteristics .	You cannot add this characteristic to the asset.
1 or greater	The characteristic's type is automatically visualized on the asset page of the asset, even if the characteristic doesn't exist yet.	You can add characteristics of this type until you reach this maximum.

Domain types

The **Domain types** page contains the hierarchy of domain types. You can select domain types to allow assets of this type to be put in domains of this type. Assets of this asset type can then be created in the domains of the selected types.

Statuses

The **Statuses** page contains a list of statuses with their description. When you create a new asset of the asset type for which you have an assignment, the asset gets the first status from this list.

Articulation

The **Articulation** page shows the [articulation score](#) calculator

Data quality rules

The **Data quality rules** page contains a list of [data quality rules](#) with their description.

Validation rules

The **Validation rules** page contains a list of [validation rules](#) with their description.

Inheritance

If an asset type does not have an assignment, then the asset type inherits all assignments of its parent asset type. If an asset type has one or more assignments, it does not inherit any assignments of its parent asset type.



Create an assignment

You can create an [assignment](#) for an asset type if you want to change the behavior of assets of this type in Collibra Data Governance Center. For example, you do this if you want to make a specific attribute type available only for assets of a certain type.

Prerequisites

- You have a [global role](#) that has the System administration [global permission](#).
- If you want to create a scoped assignment, you have created the [scope](#).

Steps

1. Open an asset type.
 - a. In the main menu, click , then  **Settings**.
 - » The [Collibra DGC settings page](#) opens.
 - b. Click **Operating Model**.
 - » The [operating model settings](#) appear on the **Asset types** tab page.
 - c. In the overview of asset types, click an asset type.
 - » The **Asset type** editor opens.

2. Create a global or scoped assignment:

Assignment type	Steps
Global assignment	<ol style="list-style-type: none"> a. In the tab pane, click Add global assignment. <ul style="list-style-type: none"> » The Add Global Assignment dialog box appears. b. Click Add global assignment. <ul style="list-style-type: none"> » The asset type no longer inherits the assignments of its parent asset types. <div style="background-color: #f0f0f0; padding: 10px; margin-top: 10px;"> <p>Note Each asset type can only have one global assignment.</p> </div>
Scoped assignment	<ol style="list-style-type: none"> a. In the tab pane, click Add assignment. <ul style="list-style-type: none"> » The Select scope for this assignment dialog box appears. b. Select a scope. <div style="background-color: #f0f0f0; padding: 10px; margin-top: 10px;"> <p>Note You can only add one scope at a time.</p> </div> c. Click Add assignment. <ul style="list-style-type: none"> » The settings of the global assignment are copied into the selected scope. <div style="background-color: #f0f0f0; padding: 10px; margin-top: 10px;"> <p>Note You can only create scoped assignments if the asset type has a global assignment.</p> </div>

What's next?

You can now [edit](#) the assignment.



Edit an assignment

You can edit an [assignment](#). For example, you do this if you want to add a specific attribute type to assets of a certain type.

Prerequisites

- You have a [global role](#) that has the System administration [global permission](#).

Steps

1. Open an asset type.
 - a. In the main menu, click , then  **Settings**.
 - » The [Collibra DGC settings page](#) opens.
 - b. Click **Operating Model**.
 - » The [operating model settings](#) appear on the **Asset types** tab page.
 - c. In the overview of asset types, click an asset type.
 - » The **Asset type** editor opens.

2. In the tab pane, click the name of the assignment.
3. Do one of the following:

Component	Steps						
Characteristics	<p>Assign one or more characteristic types to the asset type.</p> <ol style="list-style-type: none"> a. Above the table, to the right, click Edit. b. Above the table, to the right, click Add characteristic. <ul style="list-style-type: none"> » The Add a Characteristic dialog box appears. c. Click the characteristic type that you want to add. <div style="border-left: 2px solid #008000; padding-left: 10px; margin: 10px 0;"> <p>Tip You can use the filter to search for a specific characteristic type.</p> </div> <ul style="list-style-type: none"> » The characteristic type appears at the bottom of the table. d. If required, edit the minimum or maximum number of occurrences of the characteristic. <table border="1" data-bbox="571 987 1417 1637" style="width: 100%; border-collapse: collapse;"> <thead> <tr> <th data-bbox="571 987 740 1077">Option</th> <th data-bbox="740 987 1417 1077">Description</th> </tr> </thead> <tbody> <tr> <td data-bbox="571 1077 740 1379">Min.</td> <td data-bbox="740 1077 1417 1379"> <p>The minimum number of occurrences of the characteristic.</p> <p>Set this option to <i>1</i> or greater to make the characteristic appear automatically on the asset page.</p> </td> </tr> <tr> <td data-bbox="571 1379 740 1637">Max.</td> <td data-bbox="740 1379 1417 1637"> <p>The maximum number of occurrences that you can assign to an asset type.</p> <p>Leave this option empty if you don't want a limit to the maximum number of occurrences.</p> </td> </tr> </tbody> </table> e. Above the table, to the right, click Save. <ul style="list-style-type: none"> » You can now add the characteristic to the assets of this type. 	Option	Description	Min.	<p>The minimum number of occurrences of the characteristic.</p> <p>Set this option to <i>1</i> or greater to make the characteristic appear automatically on the asset page.</p>	Max.	<p>The maximum number of occurrences that you can assign to an asset type.</p> <p>Leave this option empty if you don't want a limit to the maximum number of occurrences.</p>
Option	Description						
Min.	<p>The minimum number of occurrences of the characteristic.</p> <p>Set this option to <i>1</i> or greater to make the characteristic appear automatically on the asset page.</p>						
Max.	<p>The maximum number of occurrences that you can assign to an asset type.</p> <p>Leave this option empty if you don't want a limit to the maximum number of occurrences.</p>						

Component	Steps
Domain types	<p>Assign one or more domain types to the asset type.</p> <ol style="list-style-type: none"> In the tab pane, click Domain Types. <ul style="list-style-type: none"> » The domain type table appears. Above the table, to the right, click Edit. In the domain types overview, select the domain types to assign the selected asset type to. Click Save.
Statuses	<p>Assign one or more statuses to the asset type.</p> <ol style="list-style-type: none"> In the tab pane, click Statuses. Above the table, to the right, click Edit. Above the table, to the right, click Add. In the Add status dialog box, click the status to add to the asset type. <p>Statuses in gray are already assigned to the asset type.</p> <p>Repeat this step for every status that you want to assign.</p> Click Save.
Articulation	<p>Assign one or more articulation rules.</p>
Data quality rules	<p>Assign one or more data quality rules.</p> <ol style="list-style-type: none"> In the tab pane, click Data quality rules. Above the table, to the right, click Edit. Above the table, to the right, click Add. <ul style="list-style-type: none"> » The Add data quality rule dialog box appears. Click a data quality rule. <ul style="list-style-type: none"> » The data quality rule appears at the bottom of the list of data quality rules. <p>If required, change the order.</p> Click Save.

Component	Steps
Validation rules	<p>Assign one or more validation rules to the asset type.</p> <ol style="list-style-type: none"> a. In the tab pane, click Validation rules. <ul style="list-style-type: none"> » The Asset type - Validation rules editor appears. b. Above the table, to the right, click Edit. c. Above the table, to the right, click Add. <ul style="list-style-type: none"> » The Add validation rule dialog box appears. d. Click a validation rule. <ul style="list-style-type: none"> » The validation rule appears at the bottom of the list of validation rules. <p>If required, change the order.</p> e. Click Save.

Delete an assignment



You can delete an [assignment](#). For example, you do this if you no longer want assets to have specific attribute types.

Note For some asset types, you cannot delete the global assignment because it is required for the proper functioning of Collibra Data Governance Center.

Prerequisites

- You have a [global role](#) that has the System administration [global permission](#).

Steps

1. Open an asset type.
 - a. In the main menu, click , then  **Settings**.
 - » The [Collibra DGC settings page](#) opens.
 - b. Click **Operating Model**.
 - » The [operating model settings](#) appear on the **Asset types** tab page.
 - c. In the overview of asset types, click an asset type.
 - » The **Asset type** editor opens.

2. In the tab pane, click the name of the assignment.
3. In the tab pane, click .

Note If you want to delete the global assignment, you first have to delete all scoped assignments.

4. Click **Yes**.

Note If you deleted the global assignment, the asset type inherits all assignments of its parent asset type.

Assign a characteristic type to an asset type

You can assign a [characteristic type](#) to an [asset type](#) by adding it to the asset type's [assignment](#). As a result, you can see and [add characteristics](#) of this type to assets of this type on the [asset page](#), if the asset is in the [scope](#) of the assignment.



Note

- Via the [import API](#), the [import](#) functionality or a [workflow](#), you can add characteristic types that are not in the assignment.
- The [asset page](#) only shows characteristics whose type is in the asset type's assignment.

Prerequisites

You have a [global role](#) that has the System administration [global permission](#).

Steps

1. Open an asset type.
 - a. In the main menu, click , then  **Settings**.
 - » The [Collibra DGC settings page](#) opens.
 - b. Click **Operating Model**.
 - » The [operating model settings](#) appear on the **Asset types** tab page.
 - c. In the overview of asset types, click an asset type.
 - » The **Asset type** editor opens.

2. In the tab pane, click the name of the assignment.
3. Above the table, to the right, click **Edit**.
4. Above the table, to the right, click **Add characteristic**.
 - » The **Add a Characteristic** dialog box appears.
5. Click the characteristic type that you want to add.

Tip You can use the filter to search for a specific characteristic type.

- » The characteristic type appears at the bottom of the table.
6. If required, edit the minimum or maximum number of occurrences of the characteristic.

Option	Description
Min.	The minimum number of occurrences of the characteristic. Set this option to <i>1</i> or greater to make the characteristic appear automatically on the asset page.
Max.	The maximum number of occurrences that you can assign to an asset type. Leave this option empty if you don't want a limit to the maximum number of occurrences.

7. Above the table, to the right, click **Save**.
 - » You can now **add** the characteristic to the assets of this type.



Assign a domain type to an asset type

You can assign a [domain type](#) to an [asset type](#) by adding it to the asset type's [assignment](#). As a result, you can [create](#) assets of this type in [domains](#) of this type, if the domain is in the [scope](#) of the assignment.

Prerequisites

You have a [global role](#) that has the System administration [global permission](#).

Steps

1. Open an asset type.
 - a. In the main menu, click , then  **Settings**.
 - » The [Collibra DGC settings page](#) opens.
 - b. Click **Operating Model**.
 - » The [operating model settings](#) appear on the **Asset types** tab page.
 - c. In the overview of asset types, click an asset type.
 - » The **Asset type** editor opens.
2. In the tab pane, click the name of the assignment.
3. In the tab pane, click **Domain Types**.
 - » The domain type table appears.
4. Above the table, to the right, click **Edit**.
5. In the domain types overview, select the domain types to assign the selected asset type to.
6. Click **Save**.



Assigning a status to an asset type

You can assign a [status](#) to an [asset type](#) by adding it to the asset type's [assignment](#). As a result, you can give assets of this type this status on the [asset page](#), if the asset is in the [scope](#) of the assignment.

Prerequisites

You have a [global role](#) that has the System administration [global permission](#).

Steps

1. Open an asset type.
 - a. In the main menu, click , then  **Settings**.
 - » The [Collibra DGC settings page](#) opens.
 - b. Click **Operating Model**.
 - » The [operating model settings](#) appear on the **Asset types** tab page.
 - c. In the overview of asset types, click an asset type.
 - » The **Asset type** editor opens.

2. In the tab pane, click the name of the assignment.
3. In the tab pane, click **Statuses**.
4. Above the table, to the right, click **Edit**.
5. Above the table, to the right, click **Add**.
6. In the **Add status** dialog box, click the status to add to the asset type.
Statuses in gray are already assigned to the asset type.
Repeat this step for every status that you want to assign.
7. Click **Save**.



Assign a validation rule to an asset type

You can assign a [validation rule](#) to an [asset type](#) by adding it to the asset type's [assignment](#). As a result, you can [validate](#) assets of this type against this validation rule, if the asset is in the [scope](#) of the assignment.

Prerequisites

- You have a [global role](#) that has the System administration [global permission](#).
- You have [created](#) a Validation Rule asset.

Steps

1. Open an asset type.
 - a. In the main menu, click , then  **Settings**.
 - » The [Collibra DGC settings page](#) opens.
 - b. Click **Operating Model**.
 - » The [operating model settings](#) appear on the **Asset types** tab page.
 - c. In the overview of asset types, click an asset type.
 - » The **Asset type** editor opens.
2. In the tab pane, click the name of the assignment.
3. In the tab pane, click **Validation rules**.
 - » The **Asset type - Validation rules** editor appears.
4. Above the table, to the right, click **Edit**.
5. Above the table, to the right, click **Add**.
 - » The **Add validation rule** dialog box appears.
6. Click a validation rule.
 - » The validation rule appears at the bottom of the list of validation rules.
If required, [change](#) the order.
7. Click **Save**.



Assign a data quality rule to an asset type

You can assign a [data quality rule](#) to an [asset type](#) by adding it to the asset type's [assignment](#). As a result, the [data quality dashboard](#) is available for assets of this type if the asset is in the [scope](#) of the assignment.

Prerequisites

- You have a [global role](#) that has the System administration [global permission](#).
- You have [created](#) a data quality rule.

Steps

1. Open an asset type.
 - a. In the main menu, click , then  **Settings**.
 - » The [Collibra DGC settings page](#) opens.

- b. Click **Operating Model**.
 - » The [operating model settings](#) appear on the **Asset types** tab page.
- c. In the overview of asset types, click an asset type.
 - » The **Asset type** editor opens.
2. In the tab pane, click the name of the assignment.
3. In the tab pane, click **Data quality rules**.
4. Above the table, to the right, click **Edit**.
5. Above the table, to the right, click **Add**.
 - » The **Add data quality rule** dialog box appears.
6. Click a data quality rule.
 - » The data quality rule appears at the bottom of the list of data quality rules.
If required, change the order.
7. Click **Save**.

What's next?

If the asset has all relations as defined in the aggregation path, you can go to the relevant asset pages and open the Quality tab page to see the data quality results.

Chapter 8



Overview of characteristic types

Characteristic types is a generic term for [attribute types](#), [relation types](#) and [complex relation types](#).

Attributes and attribute types

An [attribute](#) is a characteristic that describes an asset by means of an individual field. The attribute's type defines the class of information that the attribute contains.

Overview of packaged attribute types

An [attribute](#) is a characteristic that describes an asset by means of an individual field. The attribute's type defines the class of information that the attribute contains.

The table below contains all packaged [attribute types](#). You can also [create](#) new attribute types.

Type	Description	Assigned to asset type	Kind
1st Decile	The data 1st decile value.	Column	Text
1st Percentile	The data 1st percentile value.	Column	Text
1st Quartile	The data 1st quartile value.	Column	Text
3rd Quartile	The data 3rd quartile value.	Column	Text
5th Percentile	The data 5th percentile value.	Column	Text
95th Percentile	The data 95th percentile value.	Column	Text
99th Percentile	The 99th percentile value.	Column	Text
9th Decile	The data 9th decile value.	Column	Text

Type	Description	Assigned to asset type	Kind
Abbreviation	A shorthand signifier for an asset.	Report	Text
Analysis	The analysis of this issue.	Issue	Text
Application Regulation		Directory, System, Technology Asset	Text
Application Standards		Directory, System, Technology Asset	Text
Background	Background information on the asset.		Text
Calculation Rule	The rule that specifies how the KPI or metric is calculated.	KPI, Tableau Report Attribute	Text
Categorical Data	Data is considered categorical if it can only take a limited set of different values.	Column	True/False
Category	A possible value for Categorical Data.	Column	Text

Type	Description	Assigned to asset type	Kind
Certified		Data Set, Looker Dashboard, Looker Data Set, Looker Look, Looker Tile, Power BI Dashboard, Power BI Data Model, Power BI Report, Power BI Tile, Tableau Data Source, Tableau View, Tableau Workbook	True/False
Char octet Length	For character types, the maximum number of bytes in the column.	Column	Numeric
Column Position	The index of the column in the table.	Column	Numeric
Conformity Score	The amount of rows that passed the rule.	Business Rule, Data Quality Metric	Numeric
Co-role	Relationship name from tail to head.		Text
Criticality Indicator	Indicate the criticality of an asset.		True/False

Type	Description	Assigned to asset type	Kind
Data Source	The data source of an asset. It specifies where the data corresponding to this asset is coming from.		Text
Data Source Type	The type of the registered data source.	Schema	Text
Data Type	The logical Data type detected by Colibra profiling.	Column	Text
Data Type Precision	The precision of the data type. For example how many characters it can contain.	Data Attribute, Data Element, Report Attribute	Numeric
Date and/or Time Pattern	The pattern used to encode a time, date or both. Format must be compatible with a java DateTimeFormatter. Example: yyyy-MM-dd HH:mm:ss.	Column	Text
Default Value	The default value for the column.	Column	Text
Definition	The definition of the business asset. This is the shortest possible description that clearly defines the business asset.	Business Asset, Business Process, Business Term, Data Category, KPI, Line of Business, Measure, Report, Report Attribute	Text

Type	Description	Assigned to asset type	Kind
Description	<p>The description of the asset.</p> <p>This is typically a more verbose way to describe what the asset means.</p>	<p>Asset, Business Dimension, Business Rule, Code Set, Code Value, Column, Crosswalk, Data Asset, Data Attribute, Database, Data Element, Data Entity, Data Model, Data Quality Dimension, Data Quality Metric, Data Quality Rule, Data Set, Data Sharing Agreement, Data Structure, Data Usage, Directory, File, File Group, Governance Asset, Issue, Issue Category, Looker Dashboard, Looker Data Set, Looker Data Set Column, Looker Folder, Looker</p>	Text

Type	Description	Assigned to asset type	Kind
		Look, Looker Query, Looker Report Attribute, Looker Tenant, Looker Tile, Mapping Specification, Policy, Power BI Capacity, Power BI Dashboard, Power BI Data Model, Power BI Table, Power BI Column, Power BI Report, Power BI Server, Power BI Tile, Power BI Workspace, Report, Report Attribute, Role Type, Rule, S3 Bucket, S3 File System, Schema, Standard, System, Table, Tableau Data Source, Tableau Project, Tableau Report Attribute, Tableau Server, Tableau Site, Tableau View,	

Type	Description	Assigned to asset type	Kind
Descriptive Example	An example of the asset.	Asset, Business Asset, Business Process, Business Rule, Business Term, Code Set, Code Value, Data Asset, Data Attribute, Data Category, Data Element, Data Entity, Data Model, Data Quality Metric, Data Quality Rule, Data Structure, Directory, Governance Asset, Issue Category, KPI, Line of Business, Measure, Policy, Report, Role Type, Rule, Standard, System, Technology Asset	Text

Type	Description	Assigned to asset type	Kind
Document creation date	Date the document was created.	Looker Dashboard, Looker Folder, Looker Look, Tableau Data Source, Tableau View, Tableau Workbook	Date
Document last accessed date	Date the document was last accessed.	Looker Dashboard, Looker Look	Date
Document last viewed data	Date the document was last viewed.	Looker Dashboard, Looker Look	Date
Document modification date	Date the document was last edited.	Looker Look, Tableau Data Source, Tableau View, Tableau Workbook	Date
Document size	Size of the document in megabytes.	File, File Group, Tableau Workbook	Numeric

Type	Description	Assigned to asset type	Kind
Effective End Date	Date as of which an asset is scheduled to end.	Business Rule, Code Set, Code Value, Data Quality Metric, Data Quality Rule, Data Usage, Governance Asset, Issue Category, Policy, Rule	Date
Effective Start Date	Date on which asset takes effect.	Business Rule, Code Set, Code Value, Data Quality Metric, Data Quality Rule, Data Usage, Governance Asset, Issue Category, Policy, Rule	Date
Empty Values Count	The number of empty values for that column	Column	Numeric

Type	Description	Assigned to asset type	Kind
Empty values definition override	Overrides the default list of values to consider as empty or missing values during data profiling. It must be a comma separated list of text values with each value enclosed in double quotes.	Column, Schema, Table	Text
Entity Load Date	The load date of the entities from the external system.	Data Quality Metric	Text
Exception Scenario	The exception scenario.	Business Rule, Data Quality Metric, Data Quality Rule, Data Sharing Agreement, Governance Asset, Issue Category, Policy, Rule, Standard	Text
Favorites count	The number of Looker Looks and Looker Dashboards that are marked as favorite.	Looker Dashboard, Looker Look	Number
File Location		File, Schema	Text
File Type	The type of a File, which may constrain its format, its content or both.	File, File Group	Text

Type	Description	Assigned to asset type	Kind
Foreign Key Delete Rule	What happens to the foreign key when primary is deleted.	Foreign Key	Text
Foreign Key Evaluation Deferrability	Can the evaluation of the foreign key constraints be deferred until commit.	Foreign Key	Text
Foreign Key Update Rule	What happens to foreign key when primary is updated.	Foreign Key	Text
Frequency	Rate at which an asset changes over a particular period of time.	Report, Report Attribute	Text
Inclusion Scenario	The inclusion scenario	Business Rule, Data Quality Metric, Data Quality Rule, Data Usage, Governance Asset, Issue Category, Policy, Report, Report Attribute, Rule, Standard	Text
Inferred Data Type	The data type of a data asset that was automatically inferred by profiling corresponding instance data.		Text
Is Auto Incremented	Indicates whether this column is auto incremented.	Column	True/False

Type	Description	Assigned to asset type	Kind
Is Generated	Indicates whether this is a generated column.	Column	True/False
Is Mandatory	Is the asset mandatory or not.	Data Attribute	True/False
Is Nullable	Determines if the column can store NULL values.	Column	True/False
Is Primary Key	Indicates if the column is a primary key.	Column	True/False
Is Unique	If the asset is unique or not.	Data Attribute	True/False
IT Requirements	Describes the requirements from an IT perspective for the asset.	Crosswalk, Mapping Specification	Text
Key sequence	Key Sequence of an element in a foreign key		Numeric
Last Review Date	Date on which asset was last reviewed.	Code Set, Data Usage, Report, Report Attribute, Standard	Date
Last Sync Date	Date on which asset was synchronized with external system.	Code Set, Code Value, Database, Data Quality Metric, File	Date
License		Data Set	Text

Type	Description	Assigned to asset type	Kind
Loaded Rows	The number of rows that were loaded.	Business Rule, Data Quality Metric	Numeric
Loaded Values	The number of values that were loaded.		Numeric
Load Sample			Text
Location	The location where the actual asset is stored or can be found.	Asset, Code Set, Code Value, Data Asset, Data Attribute, Database, Data Element, Data Entity, Data Model, Data Structure, Directory, Report, Report Attribute, Role Type, S3 Bucket, System, Technology Asset	Text
Materiality		Data Usage	Text
Maximum Text Length	The length of the longest text value in this column	Column	Numeric
Maximum Value	The maximum value, using alphabetical order for text	Column	Text

Type	Description	Assigned to asset type	Kind
Max Length	The maximum length of any value corresponding to the data asset.		Numeric
Mean	The mean of values (numeric only), excluding missing values	Column	Numeric
Measurement	The measurement of the asset.	Business Rule, Data Quality Rule, Governance Asset, Issue Category, Policy, Rule	Numeric
Median	The data median value	Column	Text
Minimum Text Length	The length of the shortest text value in this column	Column	Numeric
Minimum Value	The minimum value, using alphabetical order for text	Column	Text
Min Length	The minimum length of any value corresponding to the data asset.		Numeric
Mode	The value with the highest frequency for a categorical feature.	Column	Text

Type	Description	Assigned to asset type	Kind
Non Conformity Score	The amount of rows that failed the rule.	Business Rule, Data Quality Metric	Numeric
Note	A note.	Asset, Business Asset, Business Process, Business Rule, Business Term, Code Set, Code Value, Data Asset, Data Attribute, Database, Data Category, Data Element, Data Entity, Data Model, Data Quality Rule, Data Structure, Directory, File, KPI, Line of Business, Measure, Policy, Report Attribute, Role Type, Standard, System, Technology Asset	Text

Type	Description	Assigned to asset type	Kind
Null Count	The number of null values in the data corresponding to the data asset.		Numeric
Number of Attributes	The number of attributes of the data entity.		Numeric
Number of distinct values	The number of different values stored in this column	Column	Numeric
Number of Files	The number of files in a File Group.	File Group	Numeric
Number Of Fractional Digits	The number of fractional digits.	Column	Numeric
Number of Values	The number of distinct instance values in the data corresponding to the data asset.		Numeric
Original Name	Name of this object in its source environment. The 'Original Name' may differ from the asset's name in Data Governance Center.	Column, Tableau Data Source, Tableau Project, Tableau Report Attribute, Tableau Site, Tableau View, Tableau Workbook	Text
Passing Fraction	The % of rows or entities that have passed the rule.	Business Rule, Data Quality Metric	Numeric

Type	Description	Assigned to asset type	Kind
Personally Identifiable Information	An indicator to flag an asset that could potentially be used to identify a specific individual.	Column	True/False
Predicate	The logical formula that will be executed to implement the rule.	Data Quality Rule	Text
Primary Key Name	The name of the primary key composed by the column.	Column	Text
Priority	The priority of this issue.	Issue	Text
Profiling Information	Provides additional information related to the status of the profiling results.	Table	Text
Purpose	The reason why the asset exists.	Business Rule, Data Sharing Agreement, Data Usage, File, Governance Asset, Issue Category, Policy, Rule, Standard	Text
Rating			Numeric
Refresh Conflict	Provides the information about the conflict detected on the Data Asset during a Schema refresh if any.	Column, Table	Text

Type	Description	Assigned to asset type	Kind
Refresh Frequency			Text
Report Image	Image of the report view	Looker Look, Tableau View, Tableau Workbook	Text
Resolution	The solution of how this issue can or is resolved.	Issue	Text
Result	The result.	Business Rule, Data Quality Metric	True/False
Role	Relationship name from head to tail.		Text
Role in Report	The use of Report Attribute in Report (for example, measure or dimension)	Tableau Report Attribute	Text
Row Count	The number of rows inside the data set, possibly including duplicated or missing values	Column	Numeric
Rows Failed	The amount of rows that failed the rule.	Data Quality Metric	Numeric
Rows Passed	The amount of rows that passed the rule.	Data Quality Metric	Numeric
Rule	The description of the rule.		Text

Type	Description	Assigned to asset type	Kind
Schema Name	The name of the schema.		Text
Scope	The scope of applications that correspond to this policy.	Crosswalk, Database, Data Usage, Directory, Mapping Specification, Policy, Report, Report Attribute, System, Technology Asset	Text
Security Classification	Classification of assets based on sensitivity.	Column, Data Usage, Report, Report Attribute	Text
Sequence Number	The sequence number of the asset. Often used to order assets in a specific way.	Data Attribute	Numeric
Size	The size of the column in the table.	Column	Numeric
Source Type	The source type of an asset.		Text
Standard Deviation	The statistical standard deviation of values (numeric only)	Column	Numeric
State			Text
State Changed by			Text

Type	Description	Assigned to asset type	Kind
State Changed Date		Data Sharing Agreement	Text
Synchronization Status	Provides information about the status of the Schema synchronization.	Schema	Text
Table Type	The table type that is declared in the data source. For example: TABLE, VIEW, ...	Table	Text
Technical Data Type	The Data Type of a data asset as it is declared by the data source. For example: String, Integer, Varchar, Blob, Boolean, ...	Column, Data Attribute, Data Element, Report Attribute, Power BI Column, Tableau Report Attribute	Text
Threshold	The minimum percentage of all rows or entities that must pass the rule.	Data Quality Metric	Numeric
Transformation Logic			Text
URL	Uniform Resource Locator, also colloquially known as web address.	Directory, File, File Group, Looker Look, S3 Bucket, Tableau Server, Tableau Site, Tableau View	Text

Type	Description	Assigned to asset type	Kind
Validation Result			True/False
Validation Script		Validation Rule	Script
Value Distribution	The distribution percentage of the values		Numeric
Variance	The statistical variance of values (numeric only)	Column	Numeric
Visible on server	Worksheet is uploaded to Tableau server.	Tableau View	True/False
Visits count	Number of visits on Tableau report	Looker Dashboard, Looker Look, Tableau View	Numeric
Weighting Factor	A factor by which some quantity is multiplied in order to make it comparable with others.		Numeric



Create an attribute type

You can create an [attribute type](#). For example, if [the packaged attributes types](#) do not meet your needs.

Prerequisites

You have a [global role](#) that has the System administration [global permission](#).

Steps

1. In the main menu, click , then  **Settings**.
 - » The [Collibra DGC settings page](#) opens.
2. In the tab pane, click **Characteristics** → **Attributes**.
3. Above the table, to the right, click **Add**.
 - » The **Create Attribute Type** dialog box appears.

4. Enter the required information.

Field	Description
Name	<p>The description of the object.</p> <p>Tip You can create multiple objects in one go. To do this, press <code>Enter</code> after typing a value and then type the next. If you type a name that already exists, it will appear in strike-through style.</p>
Description	The description of the object. This field is optional.
Kind	The kind of information that attribute of this type can contain, for example, date, number or selection.
Date	<p>A date value. If you edit attributes of this type, you can pick a date using the date selector.</p> <p>Note The date format that is displayed in the UI, can be different depending on the language settings in your user profile. For example, dd/mm/yyyy or yyyy/mm/dd.</p>
Multiple Selection	A field that allows multiple values that you can select from a predefined list.
with values	The values from which you can select one or more.
Number	A number, or a number with a fraction.

Field	Description
Only integers. (..., -2, -1, 0, 1, 2, ...)	<p>Checkbox to only allow integer numbers.</p> <div style="border: 1px solid #ccc; background-color: #f9f9f9; padding: 5px; margin-top: 10px;"> <p>Note Due to technical limitations, unexpected rounding issues may occur for numbers greater than 9,999,999,999,999,999.</p> </div>
Metric	Checkbox to make this attribute type a metric. This allows you to assign this attribute type as a metric when you create a data quality rule.
Selection	A field that allows a single value that you can select from a predefined list.
with values	The values from which you can select one.
Text	Textual input which may contain formatting.
Plain Text	Checkbox to disable formatting.
True/False	A binary option that allows you to indicate whether something is true or false.
Metric	Checkbox to make this attribute type a metric. This allows you to assign this attribute type as a metric when you create a data quality rule.

5. Click **Save**.

What's next?

You can now [assign](#) the attribute type to an asset type.

Edit an attribute type



You can edit the name and description of an [attribute type](#). You can't edit the attribute type's kind.

Tip If you want to edit an attribute type's kind, you have to delete the attribute type first and then create a new one. Keep in mind that the new attribute type will have a new ID.

Prerequisites

You have a [global role](#) that has the System administration [global permission](#).

Steps

1. In the main menu, click , then  **Settings**.
 - » The [Collibra DGC settings page](#) opens.
2. Click **Operating Model**.
 - » The [operating model settings](#) appear on the **Asset types** tab page.
3. In the tab pane, click **Characteristics** → **Attributes**.
 - » The table with attribute types appears.
4. In the table, double-click a name or description field.
5. Type the new name or description.
6. Click .



Delete an attribute type

You can delete custom [attribute types](#). You cannot delete [packaged attribute types](#).

Prerequisites

- You have a [global role](#) that has the System administration [global permission](#).
- The attribute type is not a packaged attribute type.

Steps

1. In the main menu, click , then  **Settings**.
 - » The [Collibra DGC settings page](#) opens.
2. Click **Operating Model**.
 - » The [operating model settings](#) appear on the **Asset types** tab page.
3. In the tab pane, click **Characteristics** → **Attributes**.
 - » The table with attribute types appears.
4. At the end of the row of the attribute type that you want to delete, click .
 - » The **Delete <attribute type>** dialog box appears.
5. Click **Yes**.

Relations and relation types

A relation is a characteristic that describes how two assets relate to each other. The relation's type defines the relation and determines which assets can be related.

Overview of packaged relation types

A relation is a characteristic that describes how two assets relate to each other. The relation's type defines the relation and determines which assets can be related.

The following table shows packaged relation types. You can also [create](#) new relation types.

Note

- **role** is the description of the relation type going from the head asset type to the tail asset type.
- **co-role** is the description of the relation type going from the tail asset type to the head asset type.

This is a table of all packaged relation types. For a sortable overview of all packaged relation types, see the online version of this information in the Documentation Center.

Head	Role	Co-role	Tail
Asset	complies to	applies to	Governance Asset
Asset	governed by	governs	Governance Asset
Asset	is essential for	requires	Data Usage
Asset	related to	impacted by	Asset
Asset	specializes	generalizes	Asset
Asset	uses	used in	Asset
Business Asset	groups	grouped by	Business Asset
Business Asset	has acronym	is acronym for	Acronym
Business Asset	represents	represented by	Data Asset
Business Dimension	classifies	is classified by	Asset
Business Dimension	groups	is grouped into	Report
Business Dimension	source	is source of	System
Business Process	consumes	is consumed by	Business Asset
Business Process	produces	is produced by	Business Asset
Business Term	allowed value	allowed value of	Business Term
Business Term	has code	is code for	Code Value
Business Term	synonym	synonym of	Business Term
Code Set	source of	source	Crosswalk

Head	Role	Co-role	Tail
Code Set	target of	target	Crosswalk
Code Value	groups	grouped by	Code Value
Code Value	is part of	contains	Code Set
Column	is part of	contains	Table
Data Asset	groups	is grouped by	Data Asset
Data Asset	implemented in	implements	Technology Asset
Data Asset	is essential for	is constrained by	Data Usage
Data Element	allowed value	allowed value for	Code Value
Data Element	allowed value set	applies to	Code Set
Data Element	is part of	contains	Data Structure
Data Entity	contains	is part of	Data Attribute
Data Entity	is part of	contains	Data Model
Data Quality Rule	allowed value	allowed value for	Code Value
Data Quality Rule	allowed value set	allowed value set for	Code Set
Data Quality Rule	classified by	classifies	Data Quality Dimension
Data Quality Rule	executed by	executes	Data Quality Metric
Data Quality Rule	governs	is governed by	Data Element

Head	Role	Co-role	Tail
Data Set	contains	is part of	Data Element
Data Set	related to	impacted by	Business Asset
Data Sharing Agreement	is requested by	requests	Business Dimension
Data Structure	source of	source	Mapping Specification
Data Structure	target of	target	Mapping Specification
Data Usage	is required by	requires	Data Sharing Agreement
Directory	contains	contained in	File
Directory	contains	is part of	Directory
Directory	contains	is part of	File Group
File	contains	is part of	Table
File Group	contains	is part of	Table
Governance Asset	groups	is grouped by	Governance Asset
Governance Asset	resolves	resolved by	Issue
Governance Asset	violated by	violates	Issue
Issue	categorized by	categorizes	Issue Category
Issue	has duplicate	is duplicate for	Issue
Issue	impacts	impacted by	Asset

Head	Role	Co-role	Tail
Line of Business	associates	is associated with	Business Asset
Policy	is enforced by	enforces	Rule
Report	groups	is grouped into	Report
Report	related to	is impacted by	Business Asset
Report	uses	used in	Report
Report Attribute	contained in	contains	Report
Report Attribute	is source for	is target of	Report Attribute
Role Type	is responsible for	is responsibility of	Asset
Rule	is implemented by	implements	Business Rule
S3 Bucket	contains	is part of	Directory
S3 File System	contains	is part of	S3 Bucket
Schema	contains	is part of	Table
Server	hosts	is hosted in	Business Dimension
Standard	is included in	includes	Policy
System	implements	is implemented in	Data Set
Table	is input for	has input	Transformation Rule
Table	is part of	contains	Database
Tableau Site	assembles	is assembled in	Tableau Project

Head	Role	Co-role	Tail
Technology Asset	groups	is grouped by	Technology Asset
Technology Asset	has	belongs to	Schema
Technology Asset	source system for	source system	Business Term
Technology Asset	source system for	source system	Data Asset
Technology Asset	system of record for	system of record	Business Term
Technology Asset	system of record for	system of record	Data Asset
Technology Asset	system of use for	system of use	Business Term
Technology Asset	system of use for	system of use	Data Asset
Transformation Rule	is input for	has input	Transformation Rule
Transformation Rule	produces	is produced by	Table



Create a relation type

You can create a new [relation type](#) if, for example, the [packaged relation types](#) do not meet your needs.

Prerequisites

You have a [global role](#) that has the System administration [global permission](#).

Steps

1. In the main menu, click , then  **Settings**.
 - » The [Collibra DGC settings page](#) opens.

2. Click **Operating Model**.
 - » The [operating model settings](#) appear on the **Asset types** tab page.
3. In the tab pane, click **Characteristics** → **Relations**.
4. Above the table, to the right, click **Add**.
 - » The **Create relation type** dialog box appears.
5. Enter the required information.

Element	Description
Head	Asset type of assets that can be the head of the relation.
Tail	Asset type of assets that can be the tail of the relation.
Role	The description of the relation type going from the head asset to the tail asset.
Co-role	The description of the relation type going from the tail asset to the head asset.

6. Click **Create**.

Example

The following example creates a part-whole relation type between two assets: *Data Element is part of/contains Data Structure*.

Create relation type
×

Role*

Head*

Tail*

Co-role*

Description

What's next?

You can now [assign](#) the relation type to an asset type and after that [add](#) a relation to an asset.





Edit relation types

You can edit a [relation type](#) by changing the role or co-role of a relation type or its description.

Prerequisites

You have a [global role](#) that has the System administration [global permission](#).

Steps

1. In the main menu, click , then  **Settings**.
 - » The [Collibra DGC settings page](#) opens.
2. Click **Operating Model**.
 - » The [operating model settings](#) appear on the **Asset types** tab page.
3. In the tab pane, click **Characteristics** → **Relations**.
4. In the row of the relation type that you want to edit, click  at the end of the **Role** or **Co-role** column.
5. Enter the required information and click .
 - » The relation type is edited.



Delete a relation type

You can delete a [relation type](#) that you created yourself. However, you can't delete [packaged complex relation types](#).

Prerequisites

- You have a [global role](#) that has the System administration [global permission](#).
- The relation type is not a packaged relation type.

Steps

1. In the main menu, click , then  **Settings**.
 - » The [Collibra DGC settings page](#) opens.
2. Click **Operating Model**.
 - » The [operating model settings](#) appear on the **Asset types** tab page.
3. In the tab pane, click **Characteristics** → **Relations**.
4. In the row of the relation type that you want to delete, click .
 - » The **Delete <relation type>** dialog box is shown.
5. If a dialog box appears, click **Yes**.
 - » The relation type is deleted.

Complex relations and complex relation types

A complex relation is a characteristic that describes how two or more assets relate to each other. It can also have attributes of its own, for example, Description and Priority. Technically, they are objectified associations: simplified assets that cannot exist independently. The complex relation's type defines the relations type and attributes the complex relation can have.

Overview of packaged complex relation types

A complex relation is a characteristic that describes how two or more assets relate to each other. It can also have attributes of its own, for example, Description and Priority. Technically, they are objectified associations: simplified assets that cannot exist independently. The complex relation's type defines the relations type and attributes the complex relation can have.

The table below contains all packaged [complex relation types](#). You can also [create new complex relation types](#).

Name	Description	Relation types	Attribute types	Assigned asset types
Code Mapping	Complex mapping between two or more code values	Source - Code Value (1:-) Target - Code Value (1:-) Crosswalk - Crosswalk (1:1)	<ul style="list-style-type: none"> Description (0:1) Transformation Logic (0:1) 	<ul style="list-style-type: none"> Code Value Crosswalk
Data Usage	Data Usage	Uses - Data Asset (1:-) Used in - Business Asset (1:-) Governed by - Rule (1:-)	<ul style="list-style-type: none"> Description (0:1) Materiality (0:1) 	
Fact Type		Head - Asset (1:1) Tail - Asset (1:1)	<ul style="list-style-type: none"> Role (1:-) Co-role (1:-) 	

Name	Description	Relation types	Attribute types	Assigned asset types
Field Mapping	Complex mapping between two or more data fields	Source - Data Element (1:-) Target - Data Element (1:-) Mapping specification - Mapping Specification (1: 1)	<ul style="list-style-type: none"> Description (0:1) Transformation Logic (0:1) 	<ul style="list-style-type: none"> Column Data Attribute Data Element Field Mapping Specification Report Attribute
Foreign Key Mapping	Complex mapping between two columns representing a primary key and a foreign key	Constrains - Column (1: 1) References - Column (1: 1) Is part of - Foreign Key (1: 1)	<ul style="list-style-type: none"> Key sequence (1:1) 	<ul style="list-style-type: none"> Column Foreign Key



Create a complex relation type

You can create a [complex relation type](#). For example, if the [packaged complex relation types](#) do not meet your needs.

Prerequisites

You have a [global role](#) that has the System administration [global permission](#).

Steps

1. In the main menu, click , then  **Settings**.
 - » The [Collibra DGC settings page](#) opens.
2. Click **Operating Model**.
 - » The [operating model settings](#) appear on the **Asset types** tab page.
3. In the tab pane, click **Characteristics** → **Complex Relations**.
4. Above the table, to the right, click **Add**.
 - » The **Create complex relation type** dialog box appears.
5. Enter the required information.

Field	Description
Name	The name of the complex relation type.
Description	The description of the complex relation type.
Display options	These fields allow you to edit how complex relations of this type are represented in diagrams .
Color	The default colors that you can use for the complex relation nodes of this type.
Color hex value	The hexadecimal value of the color that you want for complex relations of this type. For a list of colors and their hexadecimal values, see ColorHexa .

Field	Description
Symbol	<p>A graphical representation for complex relations of this type.</p> <p>You can choose one of the following values:</p> <ul style="list-style-type: none"> ◦ None: No graphical representation is used for complex relations of this type. ◦ Code: Complex relations of this type are represented with a code in front of them. You can specify the code that you want in the Code field. ◦ Icon: Complex relations of this type are represented with an icon in front of them. You can select the icon that you want in the Icon reference field.
Code	<p>The code that is displayed in front of complex relations of this type. This code is also displayed in the legend of diagrams.</p> <p>This field is only displayed if you have selected Code in the Symbol field.</p>
Icon reference	<p>The icon that is displayed in front of complex relations of this type. This icon is also displayed in the legend of diagrams.</p> <p>This field is only displayed if you have selected Icon in the Symbol field.</p>
Preview	<p>Two previews of the representation of complex relations of this type:</p> <ul style="list-style-type: none"> ◦ The left preview is the title bar on a complex relation page. ◦ The right preview is a diagram node.
Relations	<p>The relation types of the complex relation type.</p> <p>At least one relation type is required.</p>

Field	Description
Role	The description of the relation type going from the head asset to the tail asset.
Co-role	The description of the relation type going from the tail asset to the head asset.
Asset type	The asset type of the head of the relation. The complex relation type can only be used by assets of this asset type or its children if the complex relation type is in the asset type's assignment . The complex relation is always the tail of the complex relation type.
Min.	The minimum amount of relations of this type. You must have at least one relation with a minimum cardinality of 1 or greater.
Max.	The maximum amount of relations of this type.
Attributes	The attribute types of the complex relation type.
Attribute Type	The attribute type used by this complex relation type.
Min.	The minimum amount of attributes of this type.
Max.	The maximum amount of attributes of this type.

6. Click **Save**.

What's next?

You can now [assign](#) the complex relation type to an asset type and after that [add](#) a complex relation to an asset.

Edit a complex relation type



You can edit the name, description and display options of a [complex relation](#) type. You can't edit existing relations and attributes in the complex relation, but you can add relations and attributes to the complex relation type.

Tip If you want to edit the relations or attributes of a complex relation type, you have to delete the complex relation type first and then create a new one. Keep in mind that the new complex relation type will have a new ID.

Prerequisites

You have a [global role](#) that has the System administration [global permission](#).

Steps

1. In the main menu, click , then  **Settings**.
 - » The [Collibra DGC settings page](#) opens.
2. Click **Operating Model**.
 - » The [operating model settings](#) appear on the **Asset types** tab page.
3. In the tab pane, click **Characteristics** → **Complex Relations**.
4. In the row of the complex relation type that you want to edit, click .
 - » The **Edit complex relation** dialog box appears.
5. Enter the required information.

Field	Description
Name	The name of the complex relation type.
Description	The description of the complex relation type.
Display options	These fields allow you to edit how complex relations of this type are represented in diagrams .

Field	Description
Color	The default colors that you can use for the complex relation nodes of this type.
Color hex value	The hexadecimal value of the color that you want for complex relations of this type. For a list of colors and their hexadecimal values, see ColorHexa .
Symbol	A graphical representation for complex relations of this type. You can choose one of the following values: <ul style="list-style-type: none"> ◦ None: No graphical representation is used for complex relations of this type. ◦ Code: Complex relations of this type are represented with a code in front of them. You can specify the code that you want in the Code field. ◦ Icon: Complex relations of this type are represented with an icon in front of them. You can select the icon that you want in the Icon reference field.
Code	The code that is displayed in front of complex relations of this type. This code is also displayed in the legend of diagrams. This field is only displayed if you have selected Code in the Symbol field.
Icon reference	The icon that is displayed in front of complex relations of this type. This icon is also displayed in the legend of diagrams. This field is only displayed if you have selected Icon in the Symbol field.

Field	Description
Preview	<p>Two previews of the representation of complex relations of this type:</p> <ul style="list-style-type: none"> ◦ The left preview is the title bar on a complex relation page. ◦ The right preview is a diagram node.
Relations	<p>The relation types of the complex relation type.</p> <p>At least one relation type is required.</p>
Role	The description of the relation type going from the head asset to the tail asset.
Co-role	The description of the relation type going from the tail asset to the head asset.
Asset type	<p>The asset type of the head of the relation. The complex relation type can only be used by assets of this asset type or its children if the complex relation type is in the asset type's assignment.</p> <p>The complex relation is always the tail of the complex relation type.</p>
Min.	<p>The minimum amount of relations of this type.</p> <p>You must have at least one relation with a minimum cardinality of 1 or greater.</p>
Max.	The maximum amount of relations of this type.
Attributes	The attribute types of the complex relation type.
Attribute Type	The attribute type used by this complex relation type.

Field	Description
Min.	The minimum amount of attributes of this type.
Max.	The maximum amount of attributes of this type.

6. Click **Save**.



Delete a complex relation type

You can delete custom [complex relation types](#). However, you can't delete [packaged complex relation types](#).

Prerequisites

- You have a [global role](#) that has the System administration [global permission](#).
- The complex relation type is not a packaged complex relation type.

Steps

1. In the main menu, click , then  **Settings**.
 - » The [Collibra DGC settings page](#) opens.
2. Click **Operating Model**.
 - » The [operating model settings](#) appear on the **Asset types** tab page.
3. In the tab pane, click **Characteristics** → **Complex Relations**.
4. In the row of the complex relation type that you want to delete, click .
 - » The **Delete <complex relation type>** dialog appears.
5. Click **Yes**.
 - » The complex relation type is deleted.

Domain types

A domain type is a property of a [domain](#) that determines which assets can be included in the domain, based the [asset's type](#).

Some asset types can only be created in a specific Collibra application and in a specific [domain type](#). For example, you can only create assets of the Validation Rule type in a domain of the Validation Rule Domain type. You can see the required domain type in the [assignment](#) of the asset type.



Overview of packaged domain types

A domain type is a property of a [domain](#) that determines which assets can be included in the domain, based the [asset's type](#).

The table below contains all packaged [domain types](#) and their description.

Tip For an interactive overview of all packaged domain types, including the relevant asset types and applications, see the online version of this documentation.

Type	Type	Description
BI Catalog	BI Catalog	A collection of Tableau assets with the list of related attributes.
Business Asset Domain	Business Asset Domain	
Business Dimensions	Business Asset Domain ▶ Business Dimensions	A set of business dimensions that categorize and describe business terms.
Report Catalog	Business Asset Domain ▶ Report Catalog	A collection of reports and their definitions with the list of related report characteristics.
Codelist	Codelist	Any kind of data that is used solely to categorize other data found in a database, or solely for relating data in a database to information beyond the boundaries of the enterprise.



Type	Type	Description
Hierarchies	Codelist ▶ Hierarchies	A Code list with a hierarchical structure in its Code Values
Data Asset Domain	Data Asset Domain	
Data Usage Registry	Data Asset Domain ▶ Data Usage Registry	A collection of data usage agreements and related data structures.
Logical Data Dictionary	Data Asset Domain ▶ Logical Data Dictionary	Represents details of organizational data, independent of any particular technology, and uses vocabulary of a business area to communicate with non-technical stakeholders.
Mapping Domain	Data Asset Domain ▶ Mapping Domain	Groups data assets of the crosswalk type (to map between code sets) and mapping specification (used to map between data structures).
Physical Data Dictionary	Data Asset Domain ▶ Physical Data Dictionary	A collection of physical objects, such as tables, columns, file fields, views and APIs, to describe how data is stored, arranged and related to each other in a data storage technology/location.
Glossary	Glossary	A prioritized list of business terms and acronyms, and their meanings.
Governance Asset Domain	Governance Asset Domain	

Type	Type	Description
Assessment Review Register	Data Governance Domain › Assessment Review Register	Domain type for Assessment Review assets, which are created when an assessment is conducted on an asset and submitted for review.
Policy Domain	Data Governance Domain › Policy Domain	A set of polices and standards related to an organization.
Rulebook	Data Governance Domain › Rulebook	A set of rules that are used as a basis for making decisions and governing programs or policies.
Issue Classification	Issue Classification	
Storage Catalog	Storage Catalog	A domain type that contains assets of the asset type S3 File System or GCS File System.
Technology Asset Domain	Technology Asset Domain	An inventory of all technology assets and their business benefits.
Validation Rule Domain	Validation Rule Domain	A domain type for domains containing validation rules .

Create a domain type

You can create new [domain types](#).

Steps

1. In the main menu, click , then  **Settings**.
 - » The [Collibra DGC settings page](#) opens.
2. Click **Operating Model**.
 - » The [operating model settings](#) appear on the **Asset types** tab page.
3. In the tab pane, click **Domain Types**.
 - » The domain type table appears.
4. Above the table, to the right, click **Add**.
 - » The **Domain Type Creation** dialog box appears.
5. Enter the required information.





Option	Description
Name	Type a name for the domain type. You can enter more than one value at a time. To do this, press <i>Enter</i> after typing a value and then type the next.
Parent Type	Select the parent domain type.

6. Click **Create**.

Edit a domain type

You can edit the name and the description of a [domain type](#) in the domain type table.



Steps

1. In the main menu, click , then  **Settings**.
 - » The [Collibra DGC settings page](#) opens.
2. Click **Operating Model**.
 - » The [operating model settings](#) appear on the **Asset types** tab page.
3. In the tab pane, click **Domain Types**.
 - » The domain type table appears.
4. In the **Name** or **Description** column, do one of the following:
 - Double-click a cell.
 - Hover your mouse over a cell and click .
 - » The cell editor appears.
5. Edit the name or description.
6. Click .

Move a domain type

You can move a [domain type](#) to another parent domain type in the domain type table.

Steps

1. In the main menu, click , then  **Settings**.
 - » The [Collibra DGC settings page](#) opens.
2. Click **Operating Model**.
 - » The [operating model settings](#) appear on the **Asset types** tab page.
3. In the tab pane, click **Domain Types**.
 - » The domain type table appears.
4. At the end of a row, click .
 - » The **Select Parent Domain Type** dialog box appears.
5. Enter the required information.



Field	Description
Parent type	Select the new parent type of the domain type.

6. Click **Save**.

Delete a domain type

You can delete a [domain type](#) in the domain type table.

Steps

1. In the main menu, click , then  **Settings**.
 - » The [Collibra DGC settings page](#) opens.
2. Click **Operating Model**.
 - » The [operating model settings](#) appear on the **Asset types** tab page.
3. In the tab pane, click **Domain Types**.
 - » The domain type table appears.
4. At the end of a row, click  .
 - » The **Delete <domain type>** dialog box appears.
5. Click **Yes**.

Asset statuses

The status indicates the condition of an asset or workflow.



Overview of packaged statuses

Use statuses to reflect the life cycle of resources. The following statuses can be used out of the box in your [workflows](#).

Status	Description	Use
Accepted	<p>The stewards approved an asset definition.</p> <p>The technical stewards are granting the requested access.</p> <p>The reviewer is appointing an assignee to resolve an issue.</p>	<p>An asset is accepted at the end of the Approval and Simple Approval workflows.</p> <p>A data usage asset is accepted when the approvers, who are the owners of the resources that are part of an access request, have approved the request in the Request Assets Access workflow.</p> <p>An issue is accepted after the stewards approved its proposed solution. At this stage of the Issue Management workflow, the reviewer either appoints an assignee or marks the issue as resolved.</p>
Access Granted	<p>The requester has been granted access to the requested resources.</p>	<p>The requester is assigned a Data Analyst Level 2 role for the newly granted resources, as the final step in the Request Assets Access workflow.</p>

Status	Description	Use
Approval Pending	The approvers are voting for the approval of a data usage request.	A data usage asset has this status during the voting sub-process of the Request Assets Access workflow .
Approved		Currently not in use.
Candidate	The initial status of an asset.	Newly created assets receive this status.
Deployed	The initial status of a workflow.	Refers to workflow definitions.
Disabled	The workflow is currently not in use.	Refers to workflow definitions.
Enabled	The workflow is currently active.	Refers to workflow definitions.
Implemented		Currently not in use.
In Progress	The assignee is solving the issue.	The status is used in the Issue Management workflow .
Invalid	The reviewer rejected an issue. The initial status of a data usage asset.	Reviewers can reject invalid issues during the Issue Management workflow . Newly created data usage requests receive this status in the Request Assets Access workflow .
Monitored		Currently not in use.
New	The initial status of an issue.	Newly created issues receive this status.

Status	Description	Use
Obsolete		Currently not in use.
Pending	The requester is providing more information about an issue.	The status is used in the Issue Management workflow .
Rejected	The approvers rejected the data usage request.	The status is used in the Request Assets Access workflow .
Resolution Pending	The reviewer is validating the assignee's solution to an issue.	
Resolved	The issue is resolved.	The status is used in the Issue Management workflow .
Reviewed		Currently not in use.
Submitted for Approval	The stakeholders are verifying the proposed solution to an issue.	The status is used in the Issue Management workflow .
Under Review	<p>The stakeholders are reviewing an asset.</p> <p>The reviewer is analyzing an issue and proposing a solution.</p>	<p>An asset is under review from the moment the subject matter experts have approved its definition until it is accepted in the Approval workflow. There is no intermediary status in the Simple Approval workflow.</p> <p>After being submitted or after being rejected by the stakeholders, an issue is under review while a reviewer analyzes it, in the Issue Management workflow.</p>



Create a status

Collibra Data Governance Center comes out of the box with a large number of statuses for all the resources, for example assets and workflow tasks.

Prerequisites

You have a [global role](#) that has the System administration [global permission](#).

Steps

1. In the main menu, click , then  **Settings**.
 - » The [Collibra DGC settings page](#) opens.
2. Click **Operating Model**.
 - » The [operating model settings](#) appear on the **Asset types** tab page.
3. In the tab pane, click **Statuses**.
4. Above the table, to the right, click **Add**.
5. Type the name for the status.
 - You can create multiple statuses at once by pressing `Enter` and type another name.
 - Statuses that already exist appear in strike-through format.
6. Click **Create**.

Edit a status





You can edit the name and the description of a status.

Tip If you enter a description, it appears as a tooltip next the status on asset pages. You can use this to give more details about the status to other users.

Prerequisites

You have a [global role](#) that has the System administration [global permission](#).

Steps

1. In the main menu, click , then  **Settings**.
 - » The [Collibra DGC settings page](#) opens.
2. Click **Operating Model**.
 - » The [operating model settings](#) appear on the **Asset types** tab page.
3. In the tab pane, click **Statuses**.
4. Do one of the following in the **Name** or **Description** column:
 - Double-click a cell.
 - Hover your mouse over a cell and click .
 - » The cell editor appears.
5. Enter the new name or description.
6. Click .

Delete a status



You can delete a status if it is no longer used in any kind of workflow.

Note *Enabled*, *Disabled* and *Deployed* are system resources. They are specific to describe workflows and cannot be deleted.

Prerequisites

- You have a [global role](#) that has the System administration [global permission](#).
- The status that you want to delete is not used by any asset.

Steps

1. In the main menu, click , then  **Settings**.
 - » The [Collibra DGC settings page](#) opens.
2. Click **Operating Model**.
 - » The [operating model settings](#) appear on the **Asset types** tab page.
3. In the tab pane, click **Statuses**.
4. On the right of the status you want to delete, click .
 - » The **Delete** dialog box appears.

5. Click **Yes**.
 - » The status is deleted.

Articulation score

The articulation score of an asset is a percentage that indicates how complete the asset is according to the articulation score rules. It is typically used to give you a quick estimation of the status of the asset and whether the most important characteristics are present.

The score is shown in the title bar of the [asset page](#), a column in a [table](#) or as a field on a [tile](#).

In this section you will learn more about how the articulation score is calculated and how you can manage the articulation score rules.



Articulation scores

The articulation score of an asset is a percentage that indicates how complete the asset is according to the articulation score rules. It is typically used to give you a quick estimation of the status of the asset and whether the most important characteristics are present.

You can configure an articulation score calculator that contains your own rules. Whenever an asset is edited, either manually or via a workflow, the articulation score is reset to 0 and the articulation score rules are executed in their specific order.

The score is shown in the title bar of the asset page, a column in a [table](#) or as a field on a [tile](#).

The screenshot shows a dark-themed header for a business term. On the left, there is a blue square with 'BT' and the text 'Customer Revenue'. Below this, it says 'Type: Business Term' and 'Status: Candidate'. In the center, there are buttons for 'Edit', 'Delete', and 'more'. On the right, there is a green-bordered box containing a progress bar at 80% and a green checkmark with the word 'valid'. To the right of this box, it says 'Business Steward' followed by three user avatars: Luke O'Reilly, John Fisher, and Mary Smith, with a 'see all 4' link.

Note

- You may have to refresh the page after you edited the asset to see the new score.
- If you edited the articulation rules or their assignment, the articulation score of the assets to which it is assigned does not recalculate. You still need to edit each asset to trigger recalculation of the articulation score.

Articulation score rules

An articulation rule consists of a number of fields that determine when a rule applies and what the result is.

- The Condition field and the subsequent Status or Characteristic field determine when a rule applies. These fields allow your rule to look for a specific status or a specific characteristic. Having multiple instances of the same characteristic, for example, two notes, does not apply the rule more than once.
- The Score and Value fields determine what the effect of the articulation rule is. You can either increase the score, or set the score to a specific value.

Note

- 'Increasing the score' means that the value will be added to the percentage that was received from the other rules. It does not increase the score of the asset before it was edited.
- If a rule sets the score to a specific value, all previous rules effectively become useless.

Example

Suppose this is the articulation score calculator:

1	Condition Characteristic added	Characteristic Definition	Score Increase score by	Value 33
2	Condition Status set to	Status Candidate	Score Sets score to	Value 0
3	Condition Status set to	Status In progress	Score Sets score to	Value 10
4	Condition Status set to	Status Under review	Score Sets score to	Value 50
5	Condition Status set to	Status Reviewed	Score Sets score to	Value 80
6	Condition Status set to	Status Accepted	Score Sets score to	Value 100
7	Condition Characteristic added	Characteristic Note	Score Increase score by	Value 22

A business term has the following attributes:

- Status: In progress
- A definition
- A note
- Articulation score: 32%
 - a. Articulation score rule 1 matches and adds 33%.
 - » Current score: 33%
 - b. Articulation score rule 2 does not match.
 - c. Articulation score rule 3 matches and sets the score to 10%.
 - » Current score: 10%
 - d. Articulation score rule 4 does not match.
 - e. Articulation score rule 5 does not match.
 - f. Articulation score rule 6 does not match.
 - g. Articulation score rule 7 matches and adds 22%
 - » Final articulation score: 32%



A second note is added, the definition is deleted and the status of the business term is changed to Reviewed. It now has the following attributes:

- Status: Reviewed
- Two notes
- Articulation score: 100%
 - a. Articulation score rule 1 does not match.
 - b. Articulation score rule 2 does not match.
 - c. Articulation score rule 3 does not match.
 - d. Articulation score rule 4 does not match.
 - e. Articulation score rule 5 matches and adds 80%.
 - » Current score: 80%
 - f. Articulation score rule 6 does not match.
 - g. Articulation score rule 7 matches and adds 22%
 - » Final articulation score: 100%

Create an articulation score rule

You can create a new [articulation score](#) rule. For example, you can do this if you want to give users a quick indication about the completeness of an asset.

Steps

1. Open the scope of an asset type.
 - a. In the main menu, click , then  **Settings**.
 - » The **Collibra DGC settings page** opens.
 - b. Click **Operating Model**.
 - » The **operating model settings** appear on the **Asset types** tab page.
 - c. Click the name of an asset type.
2. In the tab pane, click <name of the scope>, then click **Articulation**.
The default scope is **Global assignment**.
3. Above the table, to the right, click **Edit**.

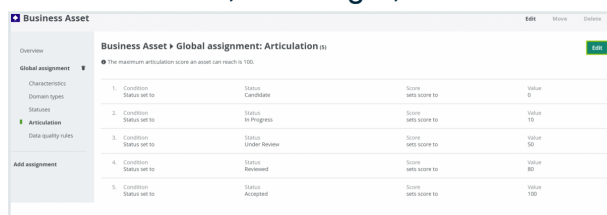

The screenshot shows the 'Business Asset' settings page for 'Global assignment: Articulation'. It features a table with 5 rows of articulation rules. Each row includes a condition, status, score, and value. An 'Edit' button is visible in the top right corner of the table area.

Condition	Status	Score	Value
1. Condition Status set to	Candidate	Score sets score to	Value 0
2. Condition Status set to	In Progress	Score sets score to	Value 10
3. Condition Status set to	Under Review	Score sets score to	Value 50
4. Condition Status set to	Reviewed	Score sets score to	Value 80
5. Condition Status set to	Accepted	Score sets score to	Value 100

4. Above the table, to the right, click **Add rule**.
 - » A new row for an articulation rule appears at the bottom of the list.

5. Enter the required information.

Field	Description
Condition	<p>The condition of the articulation rule that determines when the rule applies.</p> <ul style="list-style-type: none"> ◦ Status set to: The score depends on a specific status of an asset. ◦ Characteristic added: The score depends on a specific characteristic of an asset.
Status	<p>The specific status that an asset must have for the rule to apply.</p> <p>This field only appears if the Condition is Status set to.</p>
Characteristic	<p>The specific characteristic that an asset must have for the rule to apply.</p> <p>This field only appears if the Condition is Characteristic added.</p>
Score	<p>The impact on the score if an asset meets the condition and status or characteristic.</p> <ul style="list-style-type: none"> ◦ increase score by: Adds a value to the articulation score ◦ sets score to: Sets the articulation score to a specific value. <p>As a consequence, the previous score and the previous rules are discarded.</p>
Value	The value that is used by the rule.

6. Click **Save**.

Example

To specify that adding an attribute adds 20 % to the calculation score, configure the following:



Condition	Characteristic	Score	Value
Attribute	Certified	increase by	20

Result: The articulation calculator is added to the articulation table and is assigned to the given asset types.

Edit an articulation score rule

You can delete an [articulation score](#) rule. For example, you can do this if you want to increase the importance of a certain attribute type on the articulation score.

Steps

1. Open the scope of an asset type.
 - a. In the main menu, click , then  **Settings**.
 - » The [Collibra DGC settings page](#) opens.
 - b. Click **Operating Model**.
 - » The [operating model settings](#) appear on the **Asset types** tab page.
 - c. Click the name of an asset type.
2. In the tab pane, click <name of the scope>, then click **Articulation**.
3. Above the table, to the right, click **Edit**.

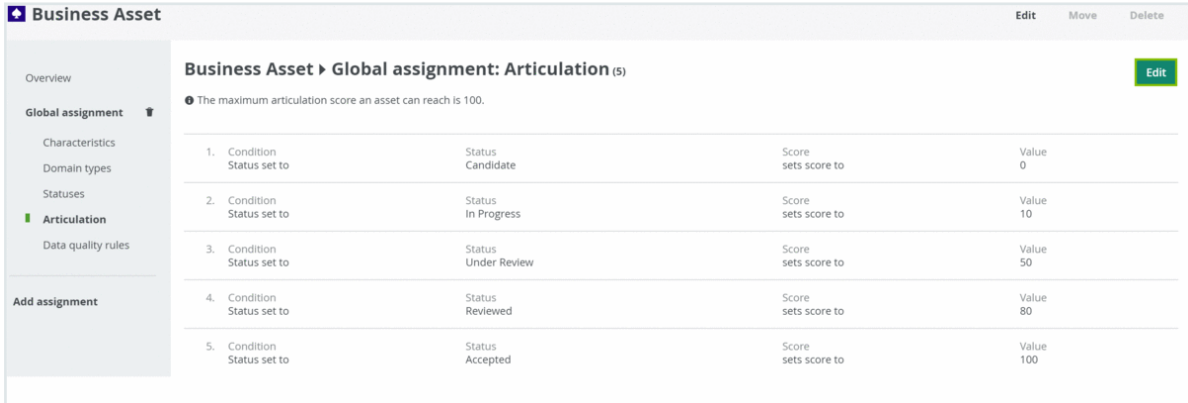

Business Asset Edit Move Delete

Overview

Global assignment ▾

- Characteristics
- Domain types
- Statuses
- Articulation**
- Data quality rules

Add assignment

Business Asset ▸ **Global assignment: Articulation** (5) Edit

● The maximum articulation score an asset can reach is 100.

1.	Condition Status set to	Status Candidate	Score sets score to	Value 0
2.	Condition Status set to	Status In Progress	Score sets score to	Value 10
3.	Condition Status set to	Status Under Review	Score sets score to	Value 50
4.	Condition Status set to	Status Reviewed	Score sets score to	Value 80
5.	Condition Status set to	Status Accepted	Score sets score to	Value 100

4. Enter the required information.



Field	Description
Condition	<p>The condition of the articulation rule that determines when the rule applies.</p> <ul style="list-style-type: none"> ◦ Status set to: The score depends on a specific status of an asset. ◦ Characteristic added: The score depends on a specific characteristic of an asset.
Status	<p>The specific status that an asset must have for the rule to apply.</p> <p>This field only appears if the Condition is Status set to.</p>
Characteristic	<p>The specific characteristic that an asset must have for the rule to apply.</p> <p>This field only appears if the Condition is Characteristic added.</p>
Score	<p>The impact on the score if an asset meets the condition and status or characteristic.</p> <ul style="list-style-type: none"> ◦ increase score by: Adds a value to the articulation score ◦ sets score to: Sets the articulation score to a specific value. As a consequence, the previous score and the previous rules are discarded.
Value	The value that is used by the rule.

5. Click **Save**.

Delete an articulation score rule

You can delete an [articulation score](#) rule. For example, you can do this if you no longer need an existing articulation score rule.

Steps

1. Open the scope of an asset type.
 - a. In the main menu, click , then  **Settings**.
 - » The [Collibra DGC settings page](#) opens.
 - b. Click **Operating Model**.
 - » The [operating model settings](#) appear on the **Asset types** tab page.
 - c. Click the name of an asset type.
2. In the tab pane, click <name of the scope>, then click **Articulation**.
3. Above the table, to the right, click **Edit**.

 **Business Asset**
Edit Move Delete

Overview

Global assignment ▾

Characteristics

Domain types

Statuses

Articulation

Data quality rules

Add assignment

Business Asset ▶ **Global assignment: Articulation** (5) Edit

• The maximum articulation score an asset can reach is 100.

1.	Condition Status set to	Status Candidate	Score sets score to	Value 0
2.	Condition Status set to	Status In Progress	Score sets score to	Value 10
3.	Condition Status set to	Status Under Review	Score sets score to	Value 50
4.	Condition Status set to	Status Reviewed	Score sets score to	Value 80
5.	Condition Status set to	Status Accepted	Score sets score to	Value 100

4. Click  next to the rule that you want to delete.
5. Click **Save**.

Asset data quality

The **Quality** page of an asset makes data quality results of an asset available to the business stakeholders. The dashboard aggregates the following values:

- Collected over time on attributes.
- Aggregated from different assets along a number of predefined relations.

The assets for which these data quality dashboards are available and how the values are aggregated are defined in [data quality rules](#), which can be edited on the **Data Quality Rule** tab on the ⚙️ **Settings** page. For the following examples, a data quality rule exists on business terms, aggregating values from data quality rules related to these business terms.

Asset quality

The assets for which the quality dashboard is available have an extra option in their tab menu, namely **Quality**. The dashboard displays the aggregated passing fraction (quality score) for the asset in the form of ring charts.

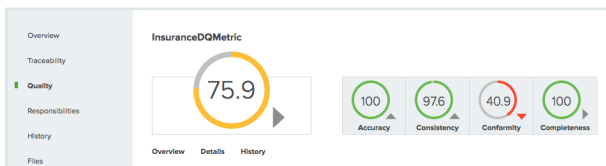

Each ring chart shows the quality score in the form of:

- A quality score as a percentage.
- A color code indicating the quality of this passing fraction:
 - Red: 0-50%
 - Orange: 50-85%
 - Green: 85 - 100%
- An arrow indicating the trend of the score compared to the previous measurement.

The first ring chart shows the general score of the asset. The ring charts next to it show subscores for a specific dimension, such as **Accuracy**, **Conformity**, **Completeness** and **Consistency**. Only values that belong to that specific dimension are then taken into account. The dimensions to use are configured in the metric group. In this example, it is the relation: **Data Quality Rule is Classified By Data Quality Dimension**.

Underneath the top pane, three selection boxes are available. They display an extra overview, details and history pane, respectively.

To close a pane, click ✕ in the upper-right corner of the pane.

Data quality overview pane

The **Overview** pane shows more information about each level in the aggregation path for the selected general score or dimension. For each level, it shows the number of involved assets of a certain type and what their results are: failing (red) or passing (gray). It also shows the total number of rows, the number of failing rows (red) and the number of passing rows (gray) that resulted in the given scores.

In the following example, the **Conformity** dimension consists of a total of 38 070 rows, 26 575 of which were failing. Two **Data Quality Rules** were involved, one of which was failing. And these **Data Quality Rules** were used by one **Data Entity**, which has an aggregated failing result.

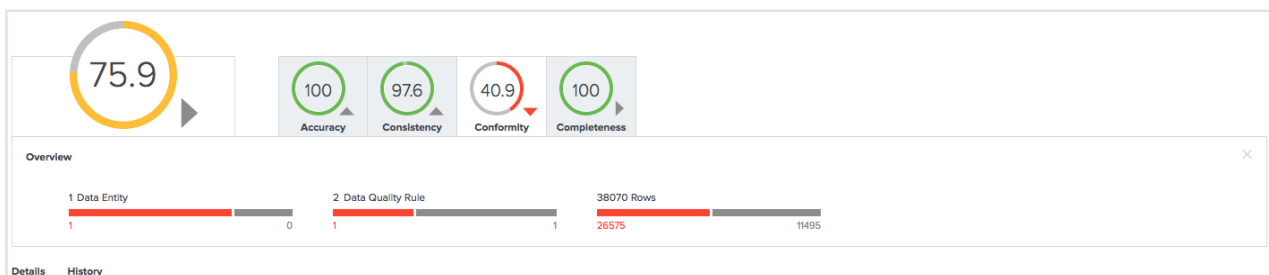

Asset quality details pane

The **Details** pane shows more information about all the assets involved in a table format.

For each asset, a row with the following default columns is shown:

- **Data Asset:** The data asset signifier
- **Rows Passed:** The number of passing rows, aggregated as a sum of the passing rows of the underlying assets
- **Rows Failed:** The number of failing rows, aggregated as a sum of the failing rows of the underlying assets
- **Quality Score:** The score aggregated as an average of the quality scores of the underlying assets

- **Result** (failing or passing): The aggregated result as a logical conjunction of the results of the underlying assets.

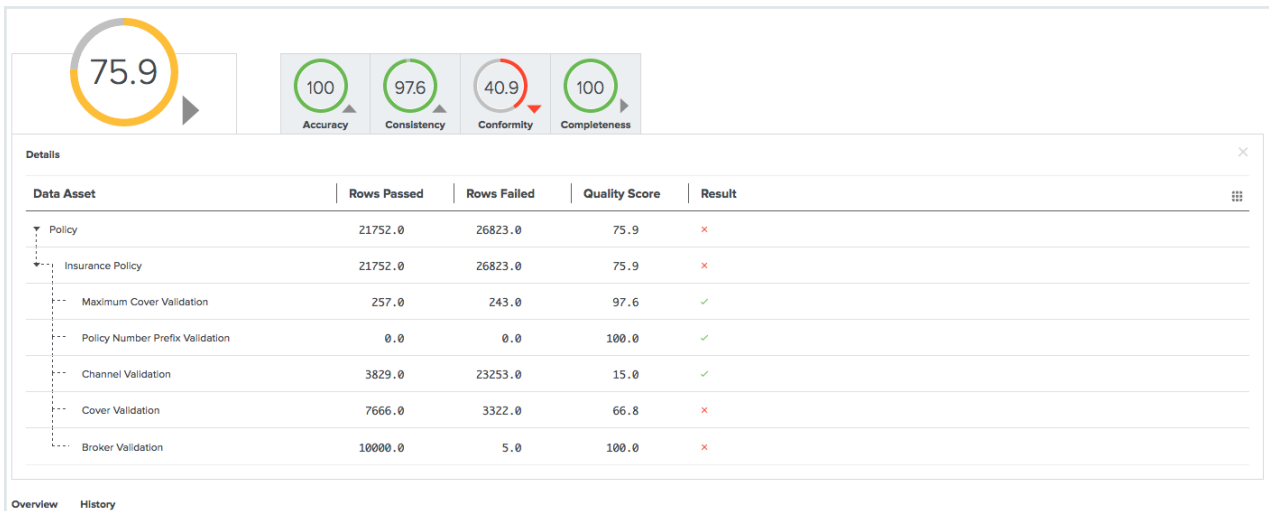

Some extra columns can be displayed in this table by clicking → **Columns**.

These include:

- **Full name**: The unique full name of the asset.
- **Domain**: The domain to which the asset belongs.
- **Type**: The type of the asset.
- **Dimension**: The dimension that applies to these assets, if any. Dimensions are used to calculate the subscores, as mentioned earlier.

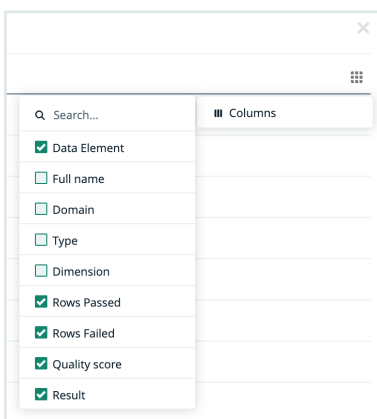

Asset quality history

The **History** pane shows the evolution of the quality score over time, for up to one month in the past.

You can display the date and the score for a specific period at the top right of the pane by hovering your pointer over that period.

When you select a period by clicking on it, the top left corner of the pane shows a trend of the score compared to the period before it.



Data quality rules

Data quality rules are rules that calculate the quality of a certain asset based on a predefined aggregation path and metrics. The results of a data quality rule are available in a [data quality dashboard](#) on the asset page of assets of the type to which you assigned the data quality rule.

Data quality and report certification

Data quality is an important aspect of report certification. However, we understand that not all organizations are at a stage in their governance program where data quality is fully enabled.

When you are certifying a report, the last step of the [Certify Report workflow](#) involves a data quality check to ensure:

- The report contains data attributes.
- All columns have positive data quality metrics.

Important Data quality is a mandatory criterion for attaining the Gold [certification level](#). If you don't have data quality configured, the highest certification level a report can attain is Silver.

About data quality rules

Data quality rules are rules that calculate the quality of a certain asset based on a predefined aggregation path and metrics.

The results of a data quality rule are available in a [data quality dashboard](#) via the Quality tab on the asset page of the asset for which you calculated its data quality. Data quality rules define for which assets the data quality dashboard is created and how the data quality values are aggregated. A data quality result aggregates values that have been collected over time on attributes and that are aggregated from different assets along a number of predefined relations.

Example

The example shows the data quality rule **Default Insurance data quality rule for business term** and is explained in more detail in the following sections.

Edit data quality rule ✕

Name*
Default Insurance data quality rule for business term

Description

Aggregation Path

Path*
Business Asset represents Data Asset | Asset governed by Governance Asset

Construct the path through which you want to calculate your aggregated scores.

Categorization*
classified by Data Quality Dimension

We can categorize all Rule elements based on a relation type. You will have the ability to see subcores on the asset types based on these categories.

Metrics

Metric	Description	Operation
Result	The result.	Logical AND
Rows Passed	The amount of rows that passed the rule.	Total
Rows Failed	The amount of rows that failed the rule.	Total
Passing Fraction	The % of rows or entities that have passed the rule.	Average

[Add Metric](#)

[Cancel](#) [Save](#)

Fields

Name and Description

The data quality rule consists of a unique name and a description that is shown in the Data quality rules table in the DGC Settings and in the assignments of an asset type.

Path

The data quality rule aggregates values that are collected through a defined aggregation path. An aggregation path consists of a chain of relations that is to be followed from the asset to which the data quality rule is assigned, to the asset containing the actual values.

In the example above, values from 'Governance Assets' are aggregated for 'Business Assets' by looking up:

- The 'Data Assets' that these business assets are represented by.
- The 'Governance Assets' that these data assets are governed by.

Categorization

Select a relation in the categorization field to create subscores for assets at the end of the aggregation path that have this relation. The data quality dashboard on the asset's page then shows these subscores. These subscores are attributes belonging to the asset that has a relation to the asset at the end of the aggregation path.

The data quality dashboard also shows subscores limited to certain dimensions, such as 'Accuracy'. The values of an asset at the end of the aggregation path are only taken into account for these subscores if the asset 'belongs' to the given dimension. An asset 'belongs' to a dimension when it has a relation of the type defined in the Categorization to that dimension. In the given example, the 'Data Quality Rule' should have a relation Classified by to, for example, the 'Accuracy' Data Quality Dimension.

Metrics

The metrics of a data quality rule define the values that are displayed in the data quality dashboard and which operation should be used when aggregating the value. These values are attributes that are available on the last asset of the aggregation path, in this example the 'Governance Asset'.

This section contains a couple of metrics that are fixed for each metrics group:

Name	Operation	Description
Rows Passed	Total	The aggregated sum of passing rows.
Rows Failed	Total	The aggregated sum of failing rows.
Result	Logical AND	The aggregated logical and of the result: failing or passing.
Passing Fraction	Average	The aggregated average of the passing fraction (quality score).

You can add extra metrics and their corresponding operation by clicking **Add Metric**.



Create a data quality rule

You can create a new [data quality rule](#).

Prerequisites

- You have a [global role](#) that has the System administration [global permission](#).

Steps

- In the main menu, click , then  **Settings**.
 - » The [Collibra DGC settings page](#) opens.
- In the tab pane, click **Data quality rules**.
- Above the table, to the right, click **Add**.

4. Enter the required information.

Field	Description
Name	The name of the data quality rule.
Description	The description of the data quality rule.
Path	The chain of relations to follow from the asset to which the data quality rule is assigned, to the asset containing the actual values.
Categorization	<p>The relation type that determines to which subscore the metric belongs.</p> <p>The values of an asset at the end of the aggregation path are only taken into account for these subscores if the asset has the relation that you enter here.</p>
Metrics	<p>The metrics of a data quality rule define the values that are displayed in the data quality dashboard and which operation should be used when aggregating the value. These values are attributes that are available on the last asset of the aggregation path.</p> <p>This section contains a couple of metrics that are fixed for each metrics group:</p> <ul style="list-style-type: none"> ◦ 'Rows Failed', operation 'Total': aggregated sum of failing rows ◦ 'Rows Passed', operation 'Total' aggregated sum of passing rows ◦ 'Passing Fraction', operation 'Average': aggregated average of the passing fraction (quality score) ◦ 'Result', operation 'Logical AND': aggregated logical and of the result: failing or passing <p>You can add extra metrics and their corresponding operation by clicking Add Metric.</p>

5. Click **Save**.

Validation rules

Validation rules are special assets of the type **Validation Rule**. They allow you to verify whether assets meet certain criteria. They have a special attribute **Validation Script**, which contains a [validation script](#) that evaluates assets of the types to which the validation rule is assigned.

Administrator actions

- Create a domain of the type **Validation rule domain**.
- [Create a validation rule](#).
- [Edit a validation rule](#).
- [Delete a validation rule](#).
- [Assign a validation rule to an asset type](#).
- [Change the order of validation rules](#).
- [Unassign a validation rule from an asset type](#).

User actions

- [Validate assets](#).
- [View the validation result](#).
- [Revalidate an asset](#).



Create a validation rule

You can create [validation rules](#) to verify whether assets meet certain criteria.

Prerequisites

- You have a domain of the type **Validation Rule Domain**.
- You have a [global role](#) that has the System administration [global permission](#).

Steps

1. Open any application, for example the Business Glossary.
2. In the main menu, click the **Create (+)** button.
 - » The **Create** dialog box appears.
3. Click the **Assets** tab.

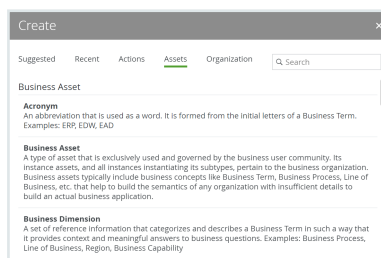

4. Click **Validation Rule**.
 - » The **Create Asset** dialog box appears.
5. Enter the required information.

Field	Description
Type	The asset type of the assets that you are creating, in this case Validation Rule .
Domain	The domain to which the new assets will belong. You can only create a asset type in any domain of a domain type that is assigned to a Validation Rule asset type.

Field	Description
Name	<p>The names of the new Validation Rule assets.</p> <div style="border: 1px solid #ccc; background-color: #f9f9f9; padding: 10px; margin-top: 10px;"> <p>Tip You can create multiple assets in one go. To do this, press <code>Enter</code> after typing a value and then type the next. Depending on the settings, asset names may have to be unique in their domain. If you type a name that already exists, it will appear in strike-through style.</p> </div>

6. Click **Create**.

» A message at the top-right of your screen confirms that one or more assets are created.

What's next?

- You can now open and [edit](#) the validation rule asset, for example to add a [validation script](#).
- [Assign](#) the validation rule to an asset type.

Edit a validation rule

You can edit [validation rules](#).

Prerequisites

- You have a [global role](#) that has the System administration [global permission](#).

Steps

1. Open a validation rule asset.
 - » The asset page appears.
2. Double-click any attribute.

3. Fill in the required information.

Note Learn more about the validation script attribute here: [Validation scripts](#).

4. Click **Save**.

Delete a validation rule

You can delete [validation rules](#) in the same way as normal assets.

You cannot delete a validation rule if it is [assigned](#) to an asset type.

Prerequisites

- You have [unassigned](#) the validation rule from asset types.
- You have a [global role](#) that has the System administration [global permission](#).

Steps

1. Open the validation rule domain to which the validation rule belongs.
2. In the first row of the validation rule table, select one or more checkboxes.
3. In the action toolbar, click **Delete**.
 - » The **Delete assets** dialog box appears.
4. Click **Yes**.



Assign a validation rule to an asset type

You can assign a [validation rule](#) to an [asset type](#) by adding it to the asset type's [assignment](#). As a result, you can [validate](#) assets of this type against this validation rule, if the asset is in the [scope](#) of the assignment.

Prerequisites

- You have a [global role](#) that has the System administration [global permission](#).
- You have [created](#) a Validation Rule asset.

Steps

1. Open an asset type.
 - a. In the main menu, click , then  **Settings**.
 - » The [Collibra DGC settings page](#) opens.
 - b. Click **Operating Model**.
 - » The [operating model settings](#) appear on the **Asset types** tab page.
 - c. In the overview of asset types, click an asset type.
 - » The **Asset type** editor opens.
2. In the tab pane, click the name of the assignment.
3. In the tab pane, click **Validation rules**.
 - » The **Asset type - Validation rules** editor appears.
4. Above the table, to the right, click **Edit**.
5. Above the table, to the right, click **Add**.
 - » The **Add validation rule** dialog box appears.
6. Click a validation rule.
 - » The validation rule appears at the bottom of the list of validation rules.
If required, [change](#) the order.
7. Click **Save**.

Change the order of validation rules



You can change the order of [validation rules](#) that are assigned to an asset type.

The order of the validation rules will determine the order in which they are executed and shown on the asset page.

Prerequisites

- You have an asset type that has multiple validation rules assigned to it.
- You have a [global role](#) that has the System administration [global permission](#).

Steps

1. Open an asset type.
 - a. In the main menu, click , then  **Settings**.
 - » The [Collibra DGC settings page](#) opens.

- b. Click **Operating Model**.
 - » The [operating model settings](#) appear on the **Asset types** tab page.
 - c. In the overview of asset types, click an asset type.
 - » The **Asset type** editor opens.
2. In the tab pane, click the name of the assignment.
3. In the tab pane, click **Validation rules**.
 - » The **Asset type - Validation rules** editor appears.
4. Above the table, to the right, click **Edit**.
5. Click \updownarrow in front of a validation rule and hold down the mouse button.
6. Move your mouse to the desired location in the order.
7. Release the mouse button.
8. Click **Save**.



Unassign a validation rule from an asset type

You can unassign a [validation rule](#) from an asset type via its [assignment](#).

Prerequisites

- A validation rule that is [assigned](#) to an asset type.
- You have a [global role](#) that has the System administration [global permission](#).

Steps

1. Open an asset type.
 - a. In the main menu, click , then  **Settings**.
 - » The [Collibra DGC settings page](#) opens.
 - b. Click **Operating Model**.
 - » The [operating model settings](#) appear on the **Asset types** tab page.
 - c. In the overview of asset types, click an asset type.
 - » The **Asset type** editor opens.
2. In the tab pane, click **Global assignment** or the scope to which you want to add the validation rule.
3. In the tab pane, click **Validation rules**.
 - » The **Asset type - Validation rules** editor appears.
4. Above the table, to the right, click **Edit**.

5. In the validation rule table, click  at the end of the line of a validation rule.
6. Click **Save**.

Executing validation rules

You can execute validation rules in many ways:

- [Validate assets](#)
Do this to manually validate assets.
- [Revalidate an asset](#)
Do this after editing an invalid asset.
- Automatically.
You can configure a workflow to start a validation on given events. For example when a asset is added or an attribute is edited.
To configure triggers on certain events, see [Getting started with workflows](#).

Validation logging

Collibra Data Governance Center can write extensive log messages from the execution of validation rules. These messages are written to the **dgc.log** file.

If the execution of a validation rule fails, analyzing the log is probably the most thorough approach.

For more information on how to configure validation logging, see [Logging](#).

Tip When contacting support regarding a problem with validation, attach the log file to the ticket.

Validate assets

Validating an asset executes all validation rules assigned to the asset type. If an asset does not meet all validation rules, the asset is invalid.

You can see the validation result on:

- An asset page's title bar.
- As a column, when viewing assets in table [display mode](#).

- As a field, when viewing assets in tiles display mode.
- As an overlay in a traceability diagram.

After validation, the **dgc.log** file will also contain more extensive messages. For more information on how to configure validation logging, see [Logging](#).

Note By default, validation is not automatically triggered when an asset is edited, so you have to revalidate it after editing an asset. However, you can create a workflow for this. To configure validation on certain events, see [Getting started with workflows](#).

Prerequisites

- Either of the following:
 - You have a [resource role](#) with the Validation Execution [resource permission](#), for example Community Manager.
 - You have a [global role](#) that has the Manage all resources [global permission](#).

Validate an asset from the asset page

1. Open an asset page.
2. In the resource toolbar, click **(validate)**.

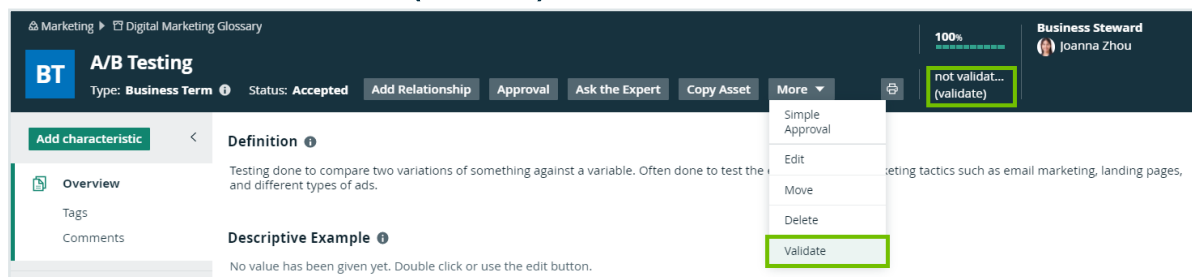

Validate one or more assets from an asset table

1. Open a set of assets in table display mode.
2. Select checkboxes in front of the assets you want to validate.
3. In the action toolbar, click **Validate**.

Validate one or more assets from a set of tiles

1. Open a set of assets in tile display mode.
2. Select the assets you want to validate.
3. In the action toolbar, click **Validate**.

Revalidate an asset

You can revalidate assets that were previously validated to see whether they meet the [validation rules](#) that are assigned to the asset type.

Validating an asset executes all validation rules that are assigned to the asset types. If an asset does not meet all validation rules, the asset is invalid.

You can see the validation result:

- An asset page's title bar.
- As a column, when viewing assets in table [display mode](#).
- As a field, when viewing assets in tiles display mode.
- As an overlay in a diagram.

Note You can create a workflow to automatically revalidate assets. To configure validation on certain events, see [Getting started with workflows](#).

Prerequisites

- Either of the following:
 - You have a [resource role](#) with the Validation Execution [resource permission](#), for example Community Manager.
 - You have a [global role](#) that has the Manage all resources [global permission](#).

Revalidate an asset from the asset page

1. Open an asset.
2. In the upper right corner, click ✓ **valid** or ✗ **invalid**.

3. Click **Revalidate**.

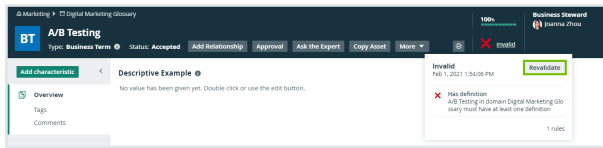

Revalidate one or more assets from an asset view

1. Open an asset table.
2. Select checkboxes in front of one or more assets.
3. In the action toolbar, click **Validate**.

Revalidate an asset from an asset view

1. Open an asset table.
2. If you don't see the **Validation Result** column, add it to the table.
More info on adding columns to a table: [Customizing tables](#).
3. Click ✓ or ✕.

You can see the validation result of each validation rule.

4. Click **Revalidate**.

<input type="checkbox"/> Name ↑	Definition	Validation Result
<input type="checkbox"/> A/B Testing	Testing done to compare two variations of something ag...	✕
<input type="checkbox"/> AdWords	Google's advertising system in which	Invalid Feb 1, 2021 1:57:25 PM
<input type="checkbox"/> Affiliate Marketing	When a publisher (website with a lo	✕ Has definition A/B Testing in domain Digital Marketing Glo ssary must have at least one definition
<input type="checkbox"/> API	Application Programming Interfaces	
<input type="checkbox"/> Attribution	Identifying which part of a marketin	
<input type="checkbox"/> Audience	The group of specific people a brand	1 rules

View the validation result

After validating or revalidating assets, you can view the result and make changes where necessary.

View the validation result from the activities list

1. Open the activities list.
 - » In the table, you see the validations.
2. In the results column, click **Result**.
 - » The **Validation results** dialog box appears.

Example

Validation results					
Rules executed					
Result	Asset	Rule	Message	Domain	
✓	Country	KDW VR1		New Business Terms	
✓	Currency Conversion	KDW VR1		New Business Terms	
✓	Customer	KDW VR1		New Business Terms	
✓	Customer Revenue	KDW VR1		New Business Terms	
✓	DDD	KDW VR1		New Business Terms	
✗	DW	KDW VR1	Name should have more than ...	New Business Terms	
✓	DWK	KDW VR1		New Business Terms	
✗	K	KDW VR1	Name should have more than ...	New Business Terms	
✓	KDW	KDW VR1		New Business Terms	
✓	Order	KDW VR1		New Business Terms	
✓	Order Date	KDW VR1		New Business Terms	
✗	W	KDW VR1	Name should have more than ...	New Business Terms	

3. The results column shows ✓ or ✗ to indicate whether they are respectively valid or invalid.

Tip If you want to fix invalid assets, you can open them by clicking them.

View the validation result on the asset page

1. Open an asset page.
2. In the upper right corner, you see ✓ **valid** or ✗ **invalid**.

View the validation result in an asset table

1. Open an asset table.
2. If you don't see the **Validation Result** column, add it to the table.
More info on adding columns to a table: [Customizing tables](#).

3. Click ✓ or ✗.

» You can see the validation result of each validation rule.

Validation scripts

A validation script is an attribute of a validation rule asset. It contains the validation logic, which expresses a single condition to evaluate assets.

The outcome of the evaluation is binary:

- **valid:** The validated asset meets the condition.
- **invalid:** The validated asset does not meet the condition.

Depending on the result, it can also show a custom message.

Validation scripts are written using a syntax that is based on Groovy, but enhanced specifically for validation rules in Collibra Data Governance Center.

Tip For general syntax-related questions, you can always refer to the [Groovy syntax](#).

Within the validation script, you can use the following features:

- [Aggregate functions](#)
- [Validation functions](#)
- [Multi-line boolean expressions](#)
- [Collections](#)
- [Closures](#)

Validation script structure

The structure of validation scripts can be basic or advanced. More information:

- [Basic script structure](#)
- [Advanced validation script structure](#)

Basic script structure

The basic script structure only contains the pure validation logic in a `rule`. More information: [Validation logic](#).

```
rule {
}
```

Example

The following script checks that the asset name is not empty and contains more than two characters.

```
rule {
  isEmpty(name, message: "Name cannot be empty") &&
  isLengthMore(name, 2, message: "Name should have more
  than 2 characters")
}
```

Advanced validation script structure

The advanced script structure contains up to three sections, which are all contained in a `rule`.

```
rule {
  given {
  }
  when {
  }
  then {
  }
}
```

Example

```
rule {
  given {
    definitions = attributes['Definition']
  }
  when {
    isEqual(type.id, \
              '00000000-0000-0000-0000-000000011001')
  }
  then {
    isEmpty(definitions, \
            message: "The asset ${name} \
            in domain ${vocabulary.name} must have
```

```

        at least one definition")
    }
}

```

Given-section

You can use this optional section to define variables that you can re-use in the rest of the script. Variables can make the rest of the validation script more readable. It allows you to separate data creation from the actual constraint-checking validation logic.

Each line of the given-section contains a variable name, an equal sign and an asset property. More info: [Asset model](#).

Example

The following given-section creates the variable *definitions*, which contains a list of the values of the **Definition** attributes.

```

given {
    definitions = attributes['Definition']
}

```

When-section

You can use this optional section if certain conditions have to be met before the rule is executed. If you do not use this section, the validation logic is applied to all assets.

If an asset does not meet these conditions, the validation logic is not executed and the outcome of the rule is **valid**.

If the conditions are met, the validation logic is executed. The outcome of the rule will then depend on the actual validation logic in the **then**-section.

Each line of the **when**-section typically contains:

1. A validation function. More info: [Validation functions](#).
2. An attribute from the given-section, an asset property or a constant value that you entered in the script.

Example

The following when-section only allows assets to be validated if they are of a specific asset type.

```
when {  
  isEqual(type.id, '00000000-0000-0000-0000-000000011001')  
}
```

Then-section

The **then**-section contains the pure validation logic. More information: [Validation logic](#).

Asset model

The asset model is the technical structure of assets. You can use the asset model to refer to specific fields of assets: its attributes and properties. This is required for optimal use of [validation rules](#).

Note This information does not apply to workflows and APIs.

Graphical representation

The asset model can be represented graphically. Further below you can find explanations on each individual field.

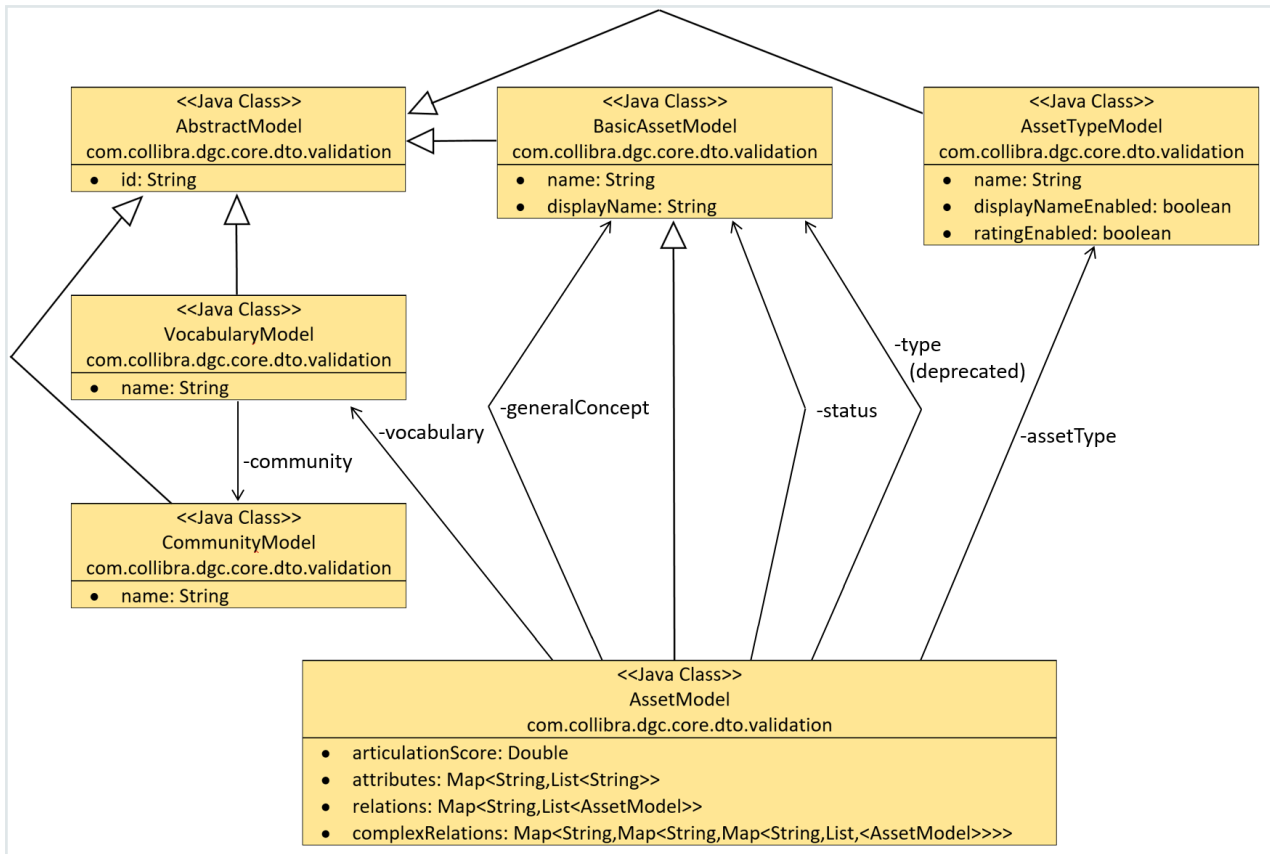

General

Field	Explanation
articulationScore	The articulation score of the asset.
id	The resource ID. Every resource that can be retrieved using the asset model has this property.
name	The full name of an asset. All resources have this property (community, vocabulary and asset).

Field	Explanation
signifier	Identical to name but only available for the BasicAssetModel. <div style="background-color: #f0f0f0; padding: 5px; border: 1px solid #ccc;"> <p>Note This field is deprecated.</p> </div>
displayName	The name of the resource. All resources have this property (community, vocabulary and asset).
status	The status of the asset.
status.id	The resource id of the status.
status.name	The name of the status.
status.signifier	Identical to status.name . <div style="background-color: #f0f0f0; padding: 5px; border: 1px solid #ccc;"> <p>Note This field is deprecated.</p> </div>
type	The asset type.
type.id	The resource ID of the asset type.
type.name	The name of the asset type.
type.signifier	Identical to type.name .
vocabulary	The domain of the asset.
vocabulary.id	The ID of the vocabulary.
vocabulary.name	The name of the vocabulary.
vocabulary.community.id	The ID of the community of the asset.

Field	Explanation
vocabulary.community.name	The name of the community of the asset.
generalConcept	The general concept of the asset. Note This field is deprecated.
generalConcept.id	The ID of the general concept. Note This field is deprecated.
generalConcept.name	The name of the general concept. Note This field is deprecated.
generalConcept.signifier	Identical to generalConcept.name . Note This field is deprecated.

Attributes

Attributes is a dictionary that contains all attribute values. You can retrieve the list for a given attribute type name or attribute type ID.

There are several possibilities to navigate the attributes of an asset.

Field	Explanation
attributes.'Definition'	The list of all Definition attribute values.
attributes['Definition']	Identical to attributes.'Definition' .

Field	Explanation
<code>attributes['00000000-0000-0000-0000-000000000202']</code>	Identical to <code>attributes.'Definition'</code> , but using the resource ID of the Definition attribute type.
<code>attributes.'00000000-0000-0000-0000-000000000202'.first()</code>	The first attribute value within the list of all the Definition attributes.
<code>attributes.'00000000-0000-0000-0000-000000000202'?.first()</code>	Identical to <code>attributes.'00000000-0000-0000-0000-000000000202'.first()</code> , but null-safe. <div style="border-left: 2px solid green; padding-left: 10px; margin-top: 10px;"> <p>Tip <code>?.</code> is the null-safe getter of Groovy. You cannot combine the <code>?.</code> with the <code>[...]</code> notation. This means that if the referenced attribute is not present, the result is null, whereas the expression without the question mark fails to execute.</p> </div>
<code>attributes['Definition'][1]</code>	The second Definition attribute value of the asset. <div style="border-left: 2px solid gray; padding-left: 10px; margin-top: 10px;"> <p>Note This uses index-based navigation of the list, and the first element has index 0.</p> </div>

Relations

Relations allow you to retrieve the list of target assets through a given relation, and each target is an asset model in itself. Navigation is done in a similar way as for attributes.

Note (Complex) Relations are only available one level deep. This means that when your script refers to a target asset through a (complex) relation, that referred asset will contain all the aspects of the asset that are mentioned above (name, attributes, etc), but without the (complex) relations of the referred asset.

Field	Explanation
relations['Related To']	The list of target assets of all Related To relations.
relations['Related To']?.first().name	The name of the first target asset using the Related To relation in a null-safe way.

Tip `?.` is the null-safe getter of Groovy. You cannot combine the `?.` with the `[...]` notation. This means that if the referenced attribute is not present, the result is null, whereas the expression without the question mark fails to execute.

Complex relations

Complex relations are a type of relation. However, because they are less predictable, not all possible relations can be listed here.

Field	Explanation
complexRelations.<complexRelationType (Name/Id)>.<firstrelationname>.<secondrelationname>	Similar to the relations, the end result will be an asset model.

Example

If you have a complex relation type

- with name **CRT** and id **1**,
- containing four relation types **up**, **down**, **left** and **right**,
- all sides referencing a business term.

These are the complex relations:

Field	Explanation
<code>complexRelations.CRT.up.right</code>	The list of the complex relations from up to right .
<code>complexRelations['CRT']['up']['right']</code>	Identical to <code>complexRelations.CRT.up.right</code> .
<code>complexRelations.'CRT'?.up?.right</code>	Identical to <code>complexRelations.CRT.up.right</code> , but does not fail in case the list of CRT is empty, nor if the up side is empty. <div style="border-left: 2px solid green; padding-left: 10px; margin-left: 20px;"> <p>Tip <code>?.</code> is the null-safe getter of Groovy. You cannot combine the <code>?.</code> with the <code>[...]</code> notation. This means that if the referenced attribute is not present, the result is null, whereas the expression without the question mark fails to execute.</p> </div>
<code>complexRelations['1'].down.up</code>	The list of the complex relations from down to up .

Asset type model

Field	Description
<code>name</code>	The full name of the asset type .
<code>displayEnabled</code>	Parameter that determines whether the Identical asset names per domain feature is enabled for the asset type.
<code>ratingEnabled</code>	Parameter that determines whether ratings are enabled for the asset type.
<code>id</code>	The resource id.

Field	Description
signifier	Identical to name but only available for the BasicAssetModel. <div style="border: 1px solid #ccc; background-color: #f9f9f9; padding: 5px; margin-top: 10px;"> <p>Note This field is deprecated.</p> </div>

Validation logic

The validation logic of a validation rule expresses the condition that is checked by the validation rule. In a basic validation script, it is contained directly in the rule. In an advanced validation script, it is contained in the **then**-section. More information: [Validation scripts](#).

Structure

Each line typically consists of:

1. A validation function. More info: [Validation functions](#).
2. An attribute from the given-section, an asset property or a constant value.
3. A message for when assets do not meet the condition of the validation function.
4. Other syntactic elements:
 - [Aggregate functions](#)
 - [Validation functions](#)
 - [Multi-line boolean expressions](#)
 - [Collections](#)
 - [Closures](#)

What's next?

If an asset does not meet the validation logic, the outcome of the rule is invalid.

If the asset meets the validation logic, the outcome of the rule is valid.

Example

```
then {
  isEmpty(attributes['Definition'],
    message: "The asset ${name} in domain ${vocabulary.name} \
```

```

    must have at least one definition")
}

```

Validation functions

Validation functions are the functions in a validation script that check for a condition. The result is a boolean: `true` or `false`.

To make the validation script more readable, there are many packaged validation functions. The built-in validation functions not only handle the validation, but they also provide a way to produce meaningful error messages. For more advanced functions, you need a closure, more information: [Closures](#).

General functions

The function...	checks whether...
<code>isEmpty (value)</code>	A value is empty, null or does not contain any element.
<code>isNotEmpty (value)</code>	A value is not empty.
<code>isEqual (value1, value2)</code>	A value is the same as a second value.
<code>isNotEqual (value1, value2)</code>	A value is not the same as a second value.
<code>isIn (value, Collection)</code>	A value is part of a collection.
<code>areIn (Collection values, Collection collection)</code>	A collection is part of another collection.
<code>isAny (Collection, Closure)</code>	Any value of a collection meets the criteria of a validation closure.
<code>isEvery (Collection, Closure)</code>	All values of a collection meet the criteria of a validation closure.

The function...	checks whether...
isFalse (value)	<p>A value is false, empty or null according to the Groovy truth.</p> <p>Examples:</p> <ul style="list-style-type: none"> • <code>isFalse (something)</code>: returns true if something is false. • <code>isFalse (something)</code>: returns false if something is true. • <code>isFalse (false)</code>: returns true. • <code>isFalse (null)</code>: returns true.
isTrue (value)	<p>A value is true, empty or null according to the Groovy truth.</p> <p>Examples:</p> <ul style="list-style-type: none"> • <code>isTrue (something)</code>: returns false if something is false. • <code>isTrue (something)</code>: returns true if something is true. • <code>isTrue (false)</code>: returns false. • <code>isTrue (null)</code>: returns true.
isUnique (Collection, Closure)	<p>All values in a collection are unique.</p> <p>Examples:</p> <ul style="list-style-type: none"> • <code>isUnique ([1, 2, 3])</code>: will evaluate to true. • <code>isUnique ([1, 2, 3, 1])</code>: will evaluate to false. <p>Examples:</p> <p>The closure <code>{it % 2}</code> allows only one even and one odd element in the list.</p> <ul style="list-style-type: none"> • <code>isUnique ([3, 4], {it % 2})</code>: will evaluate to true. • <code>isUnique ([1, 3, 4], {it % 2})</code>: will evaluate to false, because both 1 and 3 are odd.

The function...	checks whether...
validate (value)	<p>A value is a valid function, accepting any closure that is capable of returning true or false.</p> <p>Tip Validate (value) is a general validation function used to check another function.</p>

Error messages

If you add a `message` parameter in a validation function, a message appears if the result is `false`.

You can add the message parameter anywhere in the list of function parameters.

Example

```
isEmpty (value, message: "this value is not empty") is equivalent to
isEmpty (message: "this value is not empty", value).
```

You can also include parameters in your message by using `${<asset property>}`.

More info on asset properties: [Asset model](#).

Example:

```
message: "The description of the ${name} asset in domain ${vocab-
ulary.name} is empty."
```

When this message appears, `name` and `vocabulary.name` are automatically replaced by its value.

Note Message parameters entered in the when-clause will not be taken into account.

String functions

The function...	checks whether the value...
<code>isEmpty (value)</code>	Is empty or null.
<code>isNotEmpty (value)</code>	Is not empty.
<code>startsWith (value, prefix)</code>	Starts with <code>prefix</code> .
<code>contains (value, substring)</code>	Contains the given substring.
<code>endsWith (value, suffix)</code>	Ends with the given suffix.
<code>isLengthBetween (value, minLength, maxLength)</code>	Has a length between the specified range. <div style="background-color: #f0f0f0; padding: 5px; margin-top: 5px;"> <p>Note The range is inclusive. For example <code>isLengthBetween ('Hello', 2, 6)</code> is true.</p> </div>
<code>isLengthLess (value, maxLength)</code>	Has a length less than the specified length.
<code>isLengthMore (value, minLength)</code>	Has a length longer than the specified length.
<code>isLengthEq (value, length)</code>	Has the specified string length.
<code>isAlpha (value)</code>	Contains only alphabetical characters. <div style="background-color: #f0f0f0; padding: 5px; margin-top: 5px;"> <p>Note This is done through the regular expression <code>[a-zA-Z]+</code>.</p> </div>
<code>isAlphaSpace (value)</code>	Contains only alphabetical characters and spaces.
<code>isAlphanumeric (value)</code>	Contains only alphabetical characters and digits.

The function...	checks whether the value...
<code>isAlphanumSpace</code> (value)	Contains only alphabetical characters, digits, and spaces.
<code>matches</code> (value, regular expression)	<p>Matches the specified regular expression.</p> <p>A regular expression has to be placed between two forward slashes (/).</p> <p>Examples:</p> <ul style="list-style-type: none"> • <code>matches ("stream", /str.* /)</code> checks whether <code>stream</code> matches the pattern <code>str.*</code>, which will result to true. • <code>matches ("stream", /srl.* /)</code>: checks whether <code>stream</code> matches the pattern <code>srl.*</code> which results to false.

Number functions

The function...	checks whether a number...
<code>isEven</code> (number)	Is even.
<code>isOdd</code> (number)	Is odd.
<code>isGreater</code> (number1, number2)	Is greater than the second number.
<code>isGreaterEq</code> (number1, number2)	Is greater than or equal to the second number.
<code>isLess</code> (number1, number2)	Is smaller than the second number.
<code>isLessEq</code> (number1, number2)	Is smaller than or equal to the second number.

The function...	checks whether a number...
<code>isPositive (number)</code>	Is greater than zero.
<code>isNonnegative (number)</code>	Is greater than or equal to zero.
<code>isNegative (number)</code>	Is smaller than zero.
<code>isBetween (number1, number2, number3)</code>	Is greater than the second but smaller than the third number.

Date conversion functions

You can use the date conversion functions to convert the date or time from one format to another.

Implementation	Purpose
<pre> Long toTimestamp(String dateConstant) { LocalDateTime.of(LocalDate.from(DateTimeFormatter.ISO_LOCAL_ DATE.parse(dateConstant)), LocalTime.of(0, 0, 0)).atOffset(ZoneOffset.UTC).toInstant().toEpochMilli() } </pre>	<p>Converts a date constant to a timestamp.</p> <ul style="list-style-type: none"> • @param dateConstant: the date in yyyy-MM-dd format . • @return: the timestamp of the dateConstant.

Implementation	Purpose
<pre data-bbox="181 338 1031 501">String toDateConstant(Long timestamp) { Instant.ofEpochMilli(timestamp).atOffset (ZoneOffset.UTC) .format(DateTimeFormatter.ISO_LOCAL_DATE) }</pre>	<p data-bbox="1062 338 1410 465">Converts a timestamp to a date string in yyyy-MM-dd format.</p> <ul data-bbox="1062 510 1410 779" style="list-style-type: none"> • @param timestamp: the timestamp to convert. • @return: the string representation of the timestamp.
<pre data-bbox="181 831 1031 1084">String toDateConstant(Long timestamp, String pattern) { Instant.ofEpochMilli(timestamp).atOffset (ZoneOffset.UTC) .format(DateTimeFormatter.ofPattern(pat- tern, ValidationConfig.getInstance ()).getLocale()) }</pre>	<p data-bbox="1062 831 1410 958">Converts a timestamp to a string using the given pattern.</p> <ul data-bbox="1062 1003 1410 1608" style="list-style-type: none"> • @param timestamp: the timestamp to convert. • @param pattern: the pattern to use for conversion. For example: <i>yyyy-MM-dd</i>. • @return: the string representation of the timestamp in the given pattern representation.

Implementation	Purpose
<pre data-bbox="181 338 1031 501">String now() { Instant.now().atOffset(ZoneOffset.UTC).format(DateTimeFormatter.ISO_LOCAL_DATE) }</pre>	<p data-bbox="1062 338 1404 465">Returns the current date string in <code>yyyy-MM-dd</code> format.</p> <ul data-bbox="1062 510 1404 638" style="list-style-type: none"> • @return: the current date in <code>yyyy-MM-dd</code> format.

Date functions

The functions for attributes with datatype **Date**, require a long value as timestamp, in the UNIX Epoch time format `1234567890000`, and a string value as calendar date, in the ISO extended format `YYYY-MM-DD`.

The function...	checks whether a timestamp is...
<code>now()</code>	Returns the current date.
<code>isPast (Timestamp)</code>	In the past (before the system date).
<code>isFuture (Timestamp)</code>	In the future (after the system date).
<code>isEqual (Timestamp, Date)</code>	The same as the date.
<code>isLess (Timestamp, Date)</code>	Smaller than the date.
<code>isLessEq (Timestamp, Date)</code>	Smaller than or equal to the date.
<code>isGreater (Timestamp, Date)</code>	Greater than the date.

The function...	checks whether a timestamp is...
isGreaterEq (Timestamp, Date)	Greater than or equal to the date
isBetween(Timestamp, Date1, Date2)	Greater than the first but smaller than the second date.

Aggregate functions

Aggregate functions allow you to extract a value from a collection. More information on collections: [Collections](#).

They are not validation functions in itself, but can help you in retrieving data you want to refer to more easily in the rest of your validation script.

Function	Result
max (Collection)	The maximum of the given collection of values.
min (Collection)	The minimum of the given collection of values.
avg (Collection)	The average of the given collection of number values.
sum (Collection)	The sum of the given collection of number values.

Multi-line boolean expressions

The validation script of a validation rule may consist of multiple boolean expressions. To increase legibility, you can use specific constructs.

Using the constructs makes your rule a little more verbose, but more readable in most cases.

Constructions

Expression	Purpose
allOf	All the conditions have to be valid (= AND).
anyOf	One or more of the conditions have to be valid (= OR).
condition	Capture the result of a boolean to re-use in other constructs.

Examples

The examples below give the same result but are formulated in a single line, multi-line or in a hybrid construct.

Single-line expression:

```
rule {
  ((isEmpty (name) && isEqual (name, 'doesnotequal2', message:
  'shouldfail'))\
  || isEqual (name, 'doesnotequal')) && isEmpty (id)
}
```

Multi-line expression:

```
rule {
  allOf {
    anyOf {
      allOf {
        condition { isEmpty (name) }
        condition { isEqual (name, 'doesnotequal2', message:\
'shouldfail') }
      }
      condition { isEqual (name, 'doesnotequal') }
    }
    condition { isEmpty (id) }
  }
}
```

Hybrid expression:

```
rule {
  allOf {
    anyOf {
      condition { isEmpty (name) && isEqual (name,\
```

```

        'doesnotequal2', message: 'shouldfail') }
    condition { isEqual (name, 'doesnotequal') }
}
condition { isEmpty (id) }
}
}

```

Closures

A closure is a function that you can pass as an argument to another function.

It is contained by curly brackets, {<closure>}.

You can also define variables before the arrow ->

Tip For more extensive documentation about closures, please refer to the [Groovy closure](#) documentation.

Examples

Closure	Purpose
{a, b -> a + b}	<ol style="list-style-type: none"> 1. Define two variables of an undefined type. 2. Add them up. 3. Show the result.
{String a -> isEmpty (a)}	<ol style="list-style-type: none"> 1. Define a variable of the type <code>String</code>. 2. Apply the validation function <code>isEmpty</code> on it. More info: isEmpty (value).
{isEmpty (it)}	<ol style="list-style-type: none"> 1. Apply the validation function <code>isEmpty</code> on any variable that has <code>it</code> as its name. More info: isEmpty (value). <p>Tip Naming an argument is not necessary when there is only one.</p>

Collections

A collection is a list of data. Usually you create it when retrieving attributes or relations.

You can refer to a specific element in the collection in multiple ways.

Note If a reference points to a value that doesn't exist, the rule will crash. For example, retrieving the fifth value of a list that only contains four values causes a crash.

Reference	Result
<code>mylist.first()</code>	The first value in the list <code>mylist</code> .
<code>mylist.last()</code>	The last value from the list <code>mylist</code> .
<code>mylist[1]</code>	<p>The second element from the list <code>mylist</code>. The number is the index of the value you want to retrieve from the list.</p> <p>Note The first element has index zero. As a consequence, <code>mylist.first()</code> is equivalent to <code>mylist.[0]</code>.</p>
<code>mylist.get(1)</code>	The second element from the list <code>my list</code> . It is very similar to the example above.
<code>mylist?.get(1)</code>	The second element from the list. However, this syntax is null-safe. <code>?.</code> is the null-safe getter of Groovy. You cannot combine the <code>?.</code> with the <code>[...]</code> notation. This means that if the referenced attribute is not present, the result is null, whereas the expression without the question mark fails to execute.

Using the `*.` operator in collections

When using relations, you sometimes only need to have one value of the target assets, such as the name. You can use the `*.` operator for this.

Script	Purpose
<code>isIn ('expectedTargetName', relations ['Is Related To']* .name)</code>	Check whether <code>expectedTargetName</code> is in the list of all names of the target assets. The <code>* .</code> operator applies the <code>.name</code> on every target asset and creates a new list.
<code>isEvery (relations ['Is Related To']* .name, {targetName -> startsWith (targetName, 'S')})</code>	This will check that every target asset related to the current asset has a name that starts with <code>s</code> .

Validate the first element of a collection

In many situations, the first element is the only element you actually want to validate. For example, if you want to check if the first **Description** attribute is equal to a certain value, you can do this:

Script	Purpose
<code>isEqual (attributes ['Description'].first(), 'myvalue')</code>	Retrieve the first element from list of <code>Descriptions</code> and compare this to <code>myvalue</code> .
<code>isEqual (attributes ['Description'], ['myvalue'])</code>	Check whether the list of <code>Descriptions</code> is equal to the given list <code>['myvalue']</code> . This is identical to the first example, but has as a side effect that if there is more than one occurrence of the <code>Description</code> attribute, the comparison will return false. As a consequence, it validates that there is exactly one <code>Description</code> attribute.

Validation script examples

These are examples of real validation scripts of [validation rules](#).

- An asset must have at least one definition.

```
rule {
  isEmpty (attributes.'Definition'?.first(), \
    message:"The Asset ${name} in domain ${vocabulary.name}
  \
  must have at least one Definition")
}
```

- An attribute must comply to a given pattern (defined using a regular expression).

```
rule {
  given {
    codes = attributes.'Code'
  }
  when {
    isEmpty (codes)
  }
  then {
    matches (codes.first(), /S\d\d\d\d00/, \
    message: "The asset ${name} in domain \
      ${vocabulary.name} Code must start with\
      an S, then 5 digits, then 000")
  }
}
```

- All assets with a related to relation must have at least one uses relation.

```
rule {
  given {
    relatedTo = relations.'Related To'
    uses = relations.'Uses'
  }
  when {
    isEmpty (relatedTo)
  }
  then {
    isEmpty (uses, message: "Asset ${name}\
      has Related To relation, so it must \
      also have a Uses relation")
  }
}
```

- An asset must comply to the following naming rule, defined by a regular expression: starts with T, followed by 4 digits, 2 zeroes and exactly one 0, 1 or 2.

```
rule {
  matches (name, /T(\d{4})0{2}[0,1,2]/, \
    message: "Asset ${name} does not comply to naming
  rule")
}
```

- An asset name must consist of one or more words in capitals.

```
rule {
  matches(name, /(\p{Upper}+|\p{Space})*)/, \
    message: "Name ${name} should be words in capitals")
}
```

- All codes for a given asset must be in a different code list.

```
rule {
  given {
    code_domains = \
      relations.'Code'?.vocabulary?.name
  }
  then {
    isUnique (code_domains)
  }
}
```

- A code must be related to only one business term.

```
rule {
  given { terms = relations.'Business Term'
  }
  when { isEmpty (terms)
  }
  then { isEmpty (terms[1] )
  }
}
```

- All target assets using the Transform complex relation following the from and to branch, must have the same name as the current asset.

```
rule {
  isEvery (\
    complexRelations.'Transform'.from.to.name, \
    {isEqual(name, it)}, \
    message: "Not all From and To names of the \
    Transform relation are equal")
}
```

- The total score of each asset related to the current asset through an Impacted By relation may not exceed 100.

```
rule {
  given {
    impacted = relations.'Impacted By'.
    totalScoresForEachRelatedAsset = impacted?.collect\
      {it.attributes['Score'].sum {it.toInteger()}}
  }
}
```

```

when {
  isEmpty (totalScoresForEachRelatedAsset)
}
then {
  isEvery (totalScoresForEachRelatedAsset, \
    { isLessEq (it, 100)}, \
    message: 'Not all related assets have a \
      total score smaller or equal to 100')
}
}

```

- When the first target asset of the current asset using the `Is Grouped By` relation is inactive, then the current asset must be inactive. Whether or not the current asset is active or not, is based on the boolean attribute `Active`.

```

rule {
  given {
    reference = relations.'Is Grouped By'?.first()
    active = reference.attributes.'Active'?.first()
  }
  when {
    isEmpty (reference) && isFalse (active)
  }
  then {
    isFalse (active, message: "The node '${name}' in\
      '${vocabulary.name}' should also be inactive, \
      since it parent is inactive.")
  }
}

```

Scopes

A scope in Collibra Data Governance Center is a selection of [communities](#) and [domains](#) that you can refer to in an [assignment](#) of an [asset type](#). Each community or domain belongs to exactly one scope.

Default scope and custom scopes

Collibra DGC always has a default scope. Initially, all communities and domains are part of the default scope.

Depending on your requirements, you can create custom scopes and add specific communities and domains to it. If you add a community or domain to a custom scope, it is no longer part of the default scope. If you delete a custom scope, or remove communities and domains from a custom scope, the affected communities and domains revert to the default scope.

For more information about scopes after an upgrade from version 4.x to 5.x, see [Collibra Support Portal](#).

Scopes page overview

The Scopes page in the [Collibra DGC Settings](#) provides an overview of the [scopes](#) in the Collibra Data Governance Center.



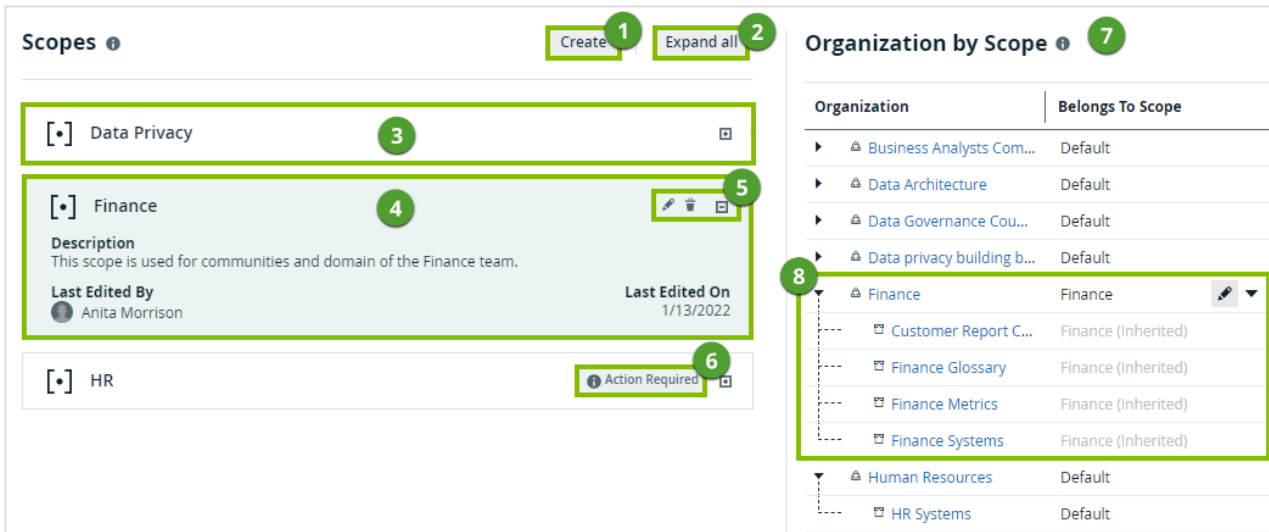

Number	Section	Description
1	Create button	Button to create a scope .
2	Expand all / Collapse all button	Button to expand or collapse all scope tiles.
3	Collapsed scope tile	Scope tile that is collapsed to reduce its size. You can expand it by clicking the button.
4	Expanded scope tile	Scope tile that is expanded, showing the metadata about the scope, such as the description.
5	Scope action buttons	Buttons to edit or delete the scope, and to collapse the scope tile.
6	Action Required warning	Warning to indicate that this scope currently does not contain any communities or domains.
7	Organization by Scope section	Section that contains an overview of communities and domains, and shows to which scope each community and domain belongs.

Number	Section	Description
8	Communities and domains per scopes	A community that belongs to a custom scope. Its domains and subcommunities inherit the same scope.



Create a scope

You can create a [scope](#), for example, if you want to create a specific [assignment](#) for assets in a certain community.

Prerequisites

- You have a [global role](#) that has the System administration [global permission](#).

Steps

- Open the Scopes page.
 - In the main menu, click , then  **Settings**.
 - » The [Collibra DGC settings page](#) opens.
 - In the **Operating model** section, click **Scopes**.
 - » The [Scopes page](#) opens.
- In the **Scopes** section, click **Create**.
 - » The **Create Scope** dialog box appears.
- Enter the required information.

Field	Description
Name	The name of the scope.
Description	The description of the scope, for example to add extra details.

- Click **Save**.

What's next?

You can now [edit the scope](#) to add domains and communities to the scope. After that, you [create](#) a scoped [assignment](#) for one or more asset types.



Edit a scope

You can edit a [scope](#), for example, if you want to change which [assignment](#) is used for a certain community or domain.



Prerequisites

- You have a [global role](#) that has the System administration [global permission](#).

Steps

- Open the Scopes page.
 - In the main menu, click , then  **Settings**.
 - » The [Collibra DGC settings page](#) opens.
 - In the **Operating model** section, click **Scopes**.
 - » The [Scopes page](#) opens.
- If required, edit the name and description of a scope:
 - Click  in the tile of the scope.
 - » The **Edit Scope** dialog box appears.
 - Enter the required information.

Field	Description
Name	The name of the scope.
Description	The description of the scope, for example to add extra details.

- Click **Save**.
- If required, add communities and domains to or remove them from a scope in the **Organization by Scope** section:
 - In the row of a community or domain, click  in the **Belongs To Scope** column.
 - » The cell editor appears.
 - Type the name of the scope, or use the drop-down menu .
 - Click .

What's next?

If required, [create](#) a scoped [assignment](#) for one or more asset types.

Delete a scope



You can delete a [scope](#), for example, if you want an [asset type](#) to use the default [assignment](#).

When you delete a scope, the asset types that used this scope, revert to other custom scopes or, if there are no other custom scopes, to the default assignment.

Prerequisites

- You have a [global role](#) that has the System administration [global permission](#).

Steps

1. Open the Scopes page.
 - a. In the main menu, click , then  **Settings**.
 - » The [Collibra DGC settings page](#) opens.
 - b. In the **Operating model** section, click **Scopes**.
 - » The [Scopes page](#) opens.
2. In the scope's tile, click .
 - » The **Delete <scope name>** dialog box appears.
3. Click **Delete**.

Workflows

You can find this section on the [Collibra Developer Portal](#).



Collibra Insights - Reporting Data Layer and Dashboard Reporting Configuration

You can find the most up-to-date technical documentation on our Documentation Center at

https://productresources.collibra.com/docs/collibra/latest/Content/Reporting/to_reporting-intro.htm

Contents

Contents	ii
Basic features	1
Collibra DGC functionalities	2
Prerequisites	24
Steps	24
Steps	40
Steps	42
Steps	43
Wrap the text of an individual cell	44
Wrap the text of all cells	44
Add columns to a table	45
Steps	45
Show responsibilities in an asset table	46
Steps	46
Edit the column order	47
Steps	47
Edit a column name	48
Steps	48
Remove columns from a table	49
Remove columns from the Table Columns dialog box	49
Remove columns from the Select Columns dialog box	49
Change the number of rows per page	51
Steps	51

Freeze columns	52
Steps	52
Steps	52
Steps	53
Apply a column filter	56
Steps	56
Clear a column filter	57
Steps	57
Enable or disable hierarchies	61
Steps	61
Steps	64
Add fields to a set of tiles	66
Steps	66
Show responsibilities in a tile set	67
Steps	67
Edit the order of the fields	68
Steps	68
Edit a field name	69
Steps	69
Remove fields from a set of tiles	70
Remove fields using the Fields dialog box	70
Remove fields using the Select fields dialog box	70
Edit the number of tiles per page	71
Steps	71
Steps	71
Sort a set of tiles	73

Steps	73
Steps	74
Asset functionalities	109
Importing and exporting	208
Diagrams	225
Via the diagram editor	295
Via the JSON text editor	295
Tips	335
Data modeling	383
Collibra DGC building blocks	384
Asset types	400
Assignments	452
Overview of characteristic types	468
Domain types	511
Asset statuses	518
Articulation score	525
Asset data quality	535
Validation rules	544
Scopes	582
Workflows	588
Contents	592
The Reporting Data Layer	597
Working with your reporting data	597
Dashboard reports	600
Reporting Data Layer tables	604
Creating the Reporting Data Layer on AWS and generating reports	606

Creating the Reporting Data Layer on GCP and generating reports	637
Improving the visual output of the Data Maturity report	675
Reporting Data Layer entity relationship diagram	685
Remove non-applicable regulation placeholder from Privacy & Risk Readiness report	702
Dashboards	704
Permissions	704
Create a dashboard	705
Copy a dashboard	706
Edit the properties of a dashboard	707
Switch to another dashboard	708
Share a dashboard	708
Delete a dashboard	708
Dashboard widgets	709
Add a widget to a dashboard	733
Move a widget	733
Edit a widget	734
Delete a widget from a dashboard	735
Data Helpdesk	737
Data Helpdesk submenu pages	737
Packaged metamodel for the Data Helpdesk	738
Issue roles	740
Create a data issue	741
Create issue: options	743
Tasks in the Issue Management workflow	744
Metrics pages	751
Data Stewardship	767

Data Stewardship submenu pages	767
Using workflows	769
Start a global workflow	770
Start an asset workflow from an asset page	770
Start an asset workflow from an asset table or set of tiles	770
My Tasks page	771
Viewing workflow tasks	773
Working with tasks	774
Collibra DGC settings	779
General settings page	780
Operating model settings page	788
Roles and permissions settings page	789
Managing workflows in Collibra DGC	823
Users and groups settings page	847
Services configuration	887
Migration	931
Replace the Collibra logo	1032
Use a custom favicon	1034

The Reporting Data Layer

The objective of the Reporting Data Layer is to make reporting easier for Collibra Data Governance Center customers. It captures all your reporting data from Collibra DGC and enables you to build reports, to visualize the data.

The Reporting Data Layer can retrieve vast amounts of data, while retaining history, and without jeopardizing Collibra DGC front-end performance. You can then use the Collibra Insights widget to show Tableau reports, or any report that can be shown as an iframe, on your Collibra DGC dashboard. If you're not using Tableau, you can still leverage the definition of the SQL view.

For information on how the different Reporting Data Layer tables can be linked, see [Reporting data layer entity relationship diagram](#).

For some example reports, showing how you can leverage the power of the Reporting Data Layer, see [Dashboard reports](#).

In this chapter

Working with your reporting data	597
Dashboard reports	600
Reporting Data Layer tables	604

Working with your reporting data

Note This functionality is only applicable for Collibra Data Governance Center 5.7.0 and newer.

Storing your reporting data

Each night, Collibra DGC stores a copy of your reporting data—all assets, attributes, relations and responsibilities, for all domains and communities, including your operating model customizations—in Collibra Data Intelligence Cloud. This includes the real data values, not just the delta.

Each data record includes a snapshot date, the date on which the data was copied. These timestamped data records are copied each day and stored for a rolling 31-day period. A copy of the data is also taken on the last day of each month, and these copies are also stored in Collibra Data Intelligence Cloud.

Processing and availability of the previous day's reporting data

Reporting data is processed in the Coordinated Universal Time (UTC) timezone.

Note

- The time at which the reporting data is ready, as identified in the last column of the following table, can vary depending on the amount of data.
- In the following table, "local time" refers to the time in the relevant region. For example, when considering the times for the eu-west-2 region, 02:00 local time means 02:00 in London.

Region	Location	Data dump (UTC)	Processing begins (UTC)	Reporting data is ready (UTC)
ap-south-east-2	Brisbane	14:00 UTC 00:00 (midnight) local time	Between 16:00 and 19:00 UTC (02:00 and 05:00 local time)	20:00 UTC 06:00 local time

Region	Location	Data dump (UTC)	Processing begins (UTC)	Reporting data is ready (UTC)
ca-central-1	Canada	04:00 UTC 00:00 local time	Between 06:00 and 09:00 UTC (02:00 and 05:00 local time)	10:00 UTC 06:00 local time
eu-west-1	Ireland	00:00 UTC 00:00 local time	Between 02:00 and 05:00 UTC (02:00 and 05:00 local time)	06:00 UTC 06:00 local time
eu-west-2	London	23:00 UTC 00:00 local time	Between 01:00 and 04:00 UTC (02:00 and 05:00 local time)	05:00 UTC 06:00 local time
us-east-1	Northern Virginia	04:00 UTC 00:00 local time	Between 06:00 and 09:00 UTC (02:00 and 05:00 local time)	10:00 UTC 06:00 local time
us-west-1	Northern California	07:00 UTC 00:00 local time	Between 09:00 and 12:00 (noon) UTC (02:00 and 05:00 local time)	13:00 UTC 06:00 local time

Downloading your data

Due to security considerations, you can't access the data directly on Collibra Data Intelligence Cloud. Therefore, we've created a REST API that enables you to download

your reporting data to a local server or your computer. You mention the snapshot date you want in the REST API, and a ZIP file of your reporting data, for the specified date, is downloaded to your hard disk.

Connecting your data and your business intelligence tool

After you've download your reporting data, you need to establish a connection between your data and your organization's business intelligence tool. In this guide, we describe the procedures via Amazon Web Services and Google Cloud Platform.

If you need assistance, contact your internal IT infrastructure team. They can advise you as to where to store the downloaded files and how to establish the connection with your organization's business intelligence tool.

Dashboard reports

You can configure three different dashboard reports.

Data Maturity

The Data Maturity report helps you track the completeness of critical assets, based on the business dimensions used in an organization.

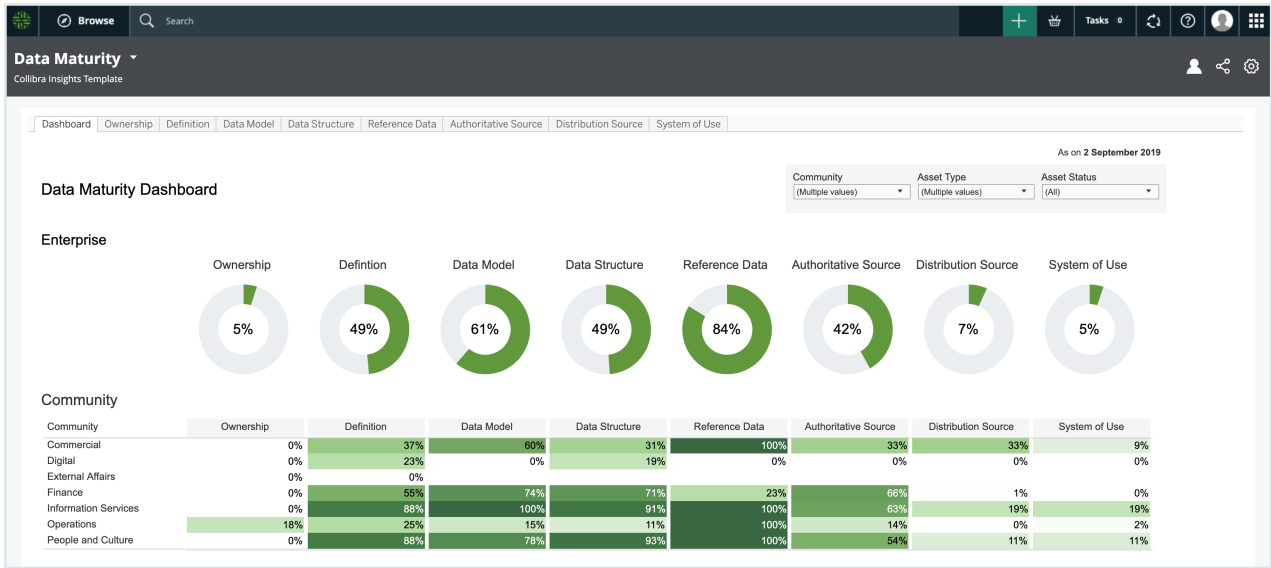

Privacy & Risk Readiness

The Privacy & Risk Readiness helps you track the development of your organization's data and progress towards compliance with the relevant regulation.

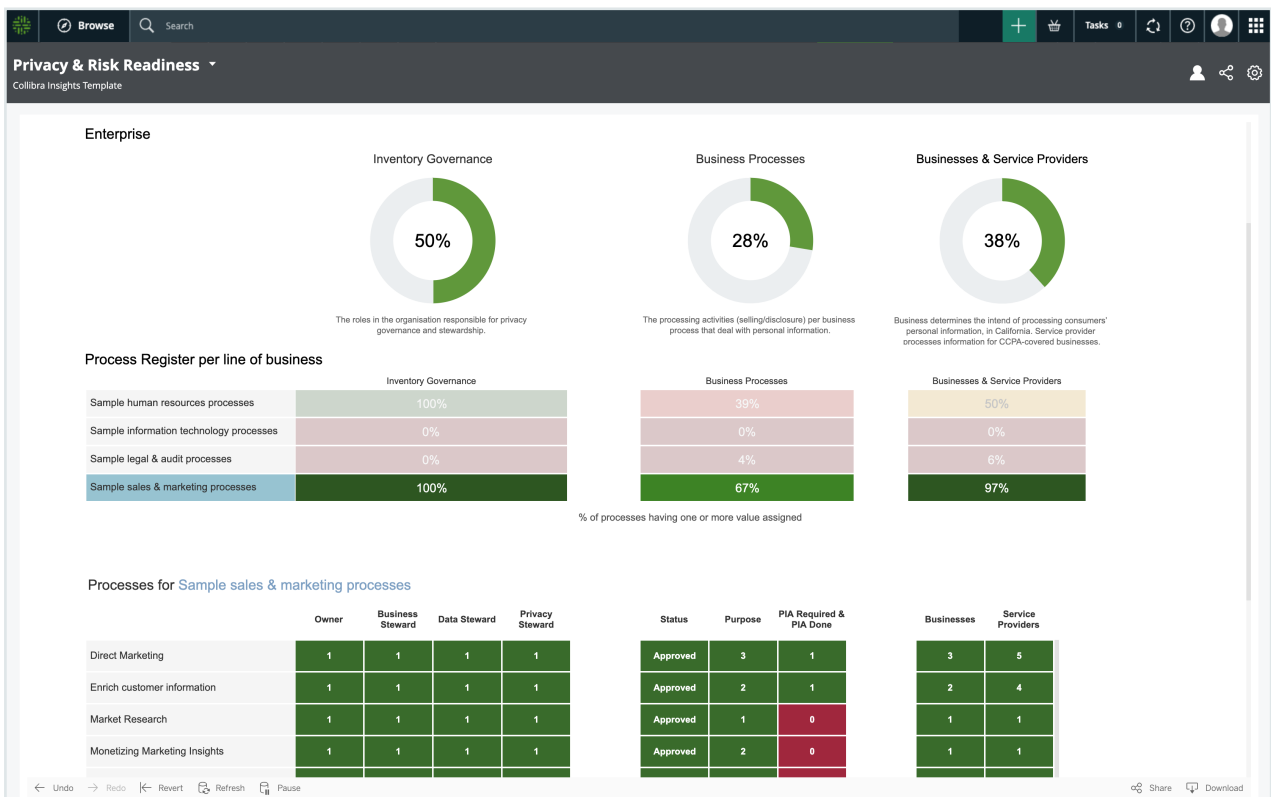

You can drill down, to view the details relative to a specific regulation, for a specific community, and select the process registers you want to monitor.

As on 28 January 2020

EU General Data Protection Regulation (GDPR)
 Regulation (EU) 2016/679 of the European Parliament and of the Council of 27 April 2016 on the protection of natural persons with regard to the and on the free movement of such data.

Enterprise

Category	Percentage
Register Governance	50%
Business Processes	24%
Controllers & Processors	36%
Data Sets	72%
Data Sharing Agreements	19%

Process Register per line of business

	Register Governance	Business Processes	Controllers & Processors	Data Sets	Data Sharing Agreements
Sample human resources processes	100%	33%	44%	96%	33%
Sample information technology processes	0%	0%	0%	0%	0%
Sample legal & audit processes	0%	4%	8%	92%	33%
Sample sales & marketing processes	100%	60%	94%	98%	8%

% of processes having one or more value assigned

Drilling down further, you can monitor the process registers of specific lines of business, including the business processes, data sets and third-parties related to a specific process register.

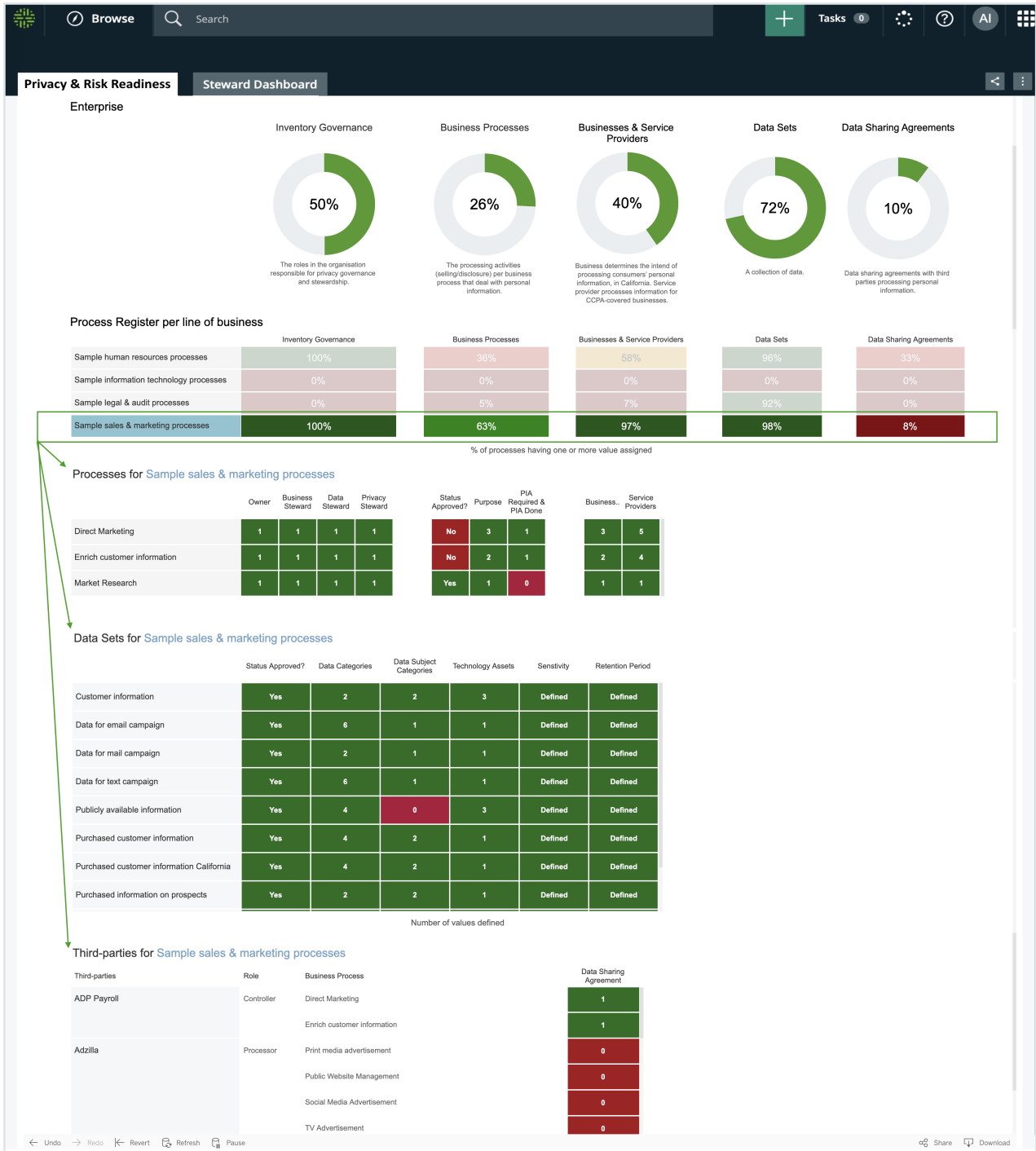

Process Register

The Process Register report shows the important information of every Business Process asset of every Process Register domain in your Collibra DGC environment. You can download the report as a printable PDF.

Process Register
Collibra Insights Template

As on 25 August 2019

Filters

Process Register: [All]

Status: [All]

Controller: [All]

Processor: [All]

Sections to display: [Multiple values]

Download PDF to print

- Click on the 'Download' button at the bottom right of the page
- Select 'PDF' as the file format
- Under 'Include dropdown', select 'Specific sheets from this dashboard'
- Select the first sheet - 'Record of processing activities'
- Select desired Paper size or Orientation like e.g. letter or A4
- Click 'Create PDF'
- A PDF file will be created and you will be presented with the option to Download it.

Process Register

Process Register	Business Process	Legal Information	Contacts
Sample human resources processes	Audit & Internal Controls	Indication whether the processing concerns sensitive data	3 - Internal Use
Categories of data subjects			
		Present employees	-
		Present employees (CCPA)	-
		Present employees (GDPR)	-
Data categories			
		Contact information	-
		Contract information	-
		Education information	-
		Employment information	-
		Personal and family details	-
		Personal information	-
Recipients	BigBossCorp	Contact person	BigBossCorp, Contact: info@bigbosscorp.com, r...

← Undo → Redo ↶ Revert ↷ Refresh ⏸ Pause

View: Original ⏲ Alert ✎ Edit ⚙ Share 📄 Download

Reporting Data Layer tables

The Reporting Data Layer is comprised of eight tables. These tables reflect the data that can be accessed through the Collibra DGC UI:

- The community hierarchy.
- All domains.
- All assets, including assets of custom asset types.
- All asset tags.
- All attributes related to these assets, such as Definition, Description and custom attributes types.
- All relations related to these assets, such as “categorizes” and “is categorized by”, including custom relation types.
- All complex relations.
- Responsibilities, such as Owner and Stakeholder, for a given resource.

Note Only responsibilities that are directly assigned at the asset level or domain level are included in the Reporting Data Layer. Inherited responsibilities from the community level are not.

This is the reporting data that is copied and stored in Collibra Data Intelligence Cloud, on a daily basis.

Creating the Reporting Data Layer on AWS and generating reports

Before configuring the [dashboard reports](#), you have to create the [Reporting Data Layer](#) on Amazon Web Services (AWS). You can then create your dashboard reports via Collibra Console or URL.

In this chapter

Create the Reporting Data Layer on AWS

This section provides information on how to create the [Reporting Data Layer](#) on Amazon Web Services (AWS), with S3 bucket storage and AWS Athena query service. You can, however, use alternative software. We also provide documentation on how to [create the reporting data on Google Cloud Platform](#).

Prerequisites

You have:

- A license for Collibra Insights.
- Collibra Data Intelligence Cloud 5.7 or newer.
- Software for working with Parquet files.

Steps

1. [Download a data snapshot from your Collibra DGC environment](#)
2. [Upload the data to an S3 bucket](#)
3. [Download the Reporting Data Layer from Collibra Marketplace](#)
4. [Create the Reporting Data Layer model in AWS Athena](#)

Step 1: Download a data snapshot from your Collibra DGC environment

1. Enter the following URL in your browser:
`<your-DGC-environment-URL>/rest/2.0/reporting/insights/download?snapshotDate=<snapshot_date>&-format=zip`, where `<snapshot date>` is the date from which you want the data, formatted as YYYY-MM-DD, for example "2019-07-23".
 - » A ZIP file of the data from your Collibra DGC environment, for the specified date, is downloaded to your hard disk.
2. Extract the ZIP files on your local computer.
 - » A folder with the name of the ZIP file is created.

Step 2: Upload the data to an S3 bucket

Note This only needs to be done once for the collection Tableau workbook files. After that, you only need to carry out this step if the data layer model changes.

1. Sign in to your AWS account.
2. In the main menu, expand the **Services** page, and then select **S3**.
3. In the **Buckets** tab, click **Create bucket**.

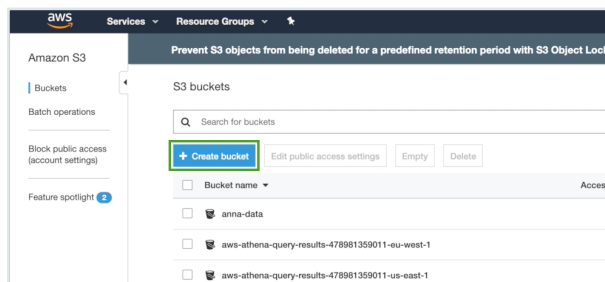

- » The **Create bucket** dialog box appears.
4. In the **Bucket name** field, enter a name for the bucket you are creating, for example "collibra-insights".
 5. Click **Next**.
 6. Click **Next**, to bypass the configuration options.

7. Clear the **Block all public access** check box, to allow access to Tableau.

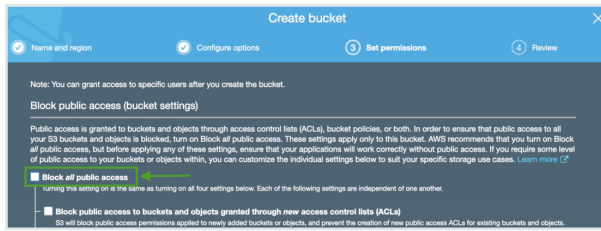

8. Click **Next**.
9. Click **Create bucket**.
 - » The bucket is created.
10. In the **Buckets** tab, search for your newly created bucket, and then click on it.

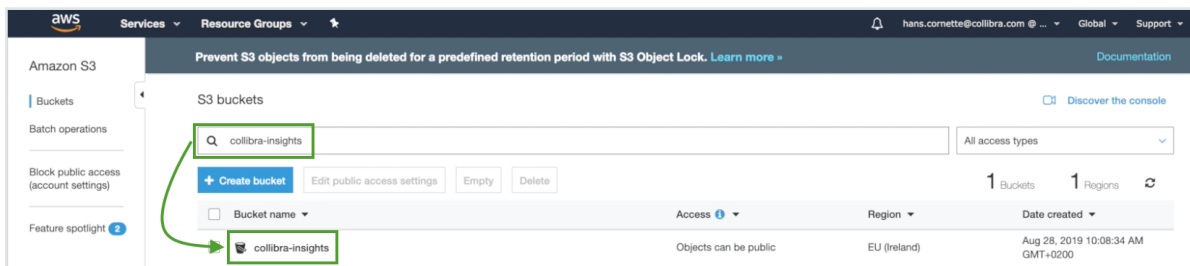

- » The bucket details page opens.
11. Click **Upload**, to upload the data you downloaded from your Collibra DGC environment.

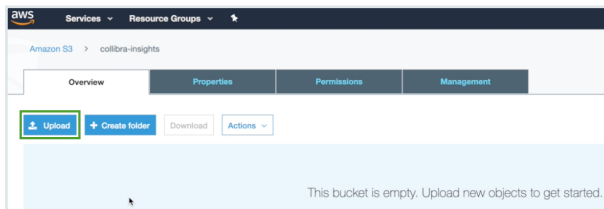

- » The **Upload** dialog box appears.
12. Click **Add files**, or drag and drop into the dialog box all of the folders in the ZIP file you downloaded from your Collibra DGC environment.



- » The folders appear in the Upload dialog box.

13. Click Upload.

» The folders are added to the newly created bucket.

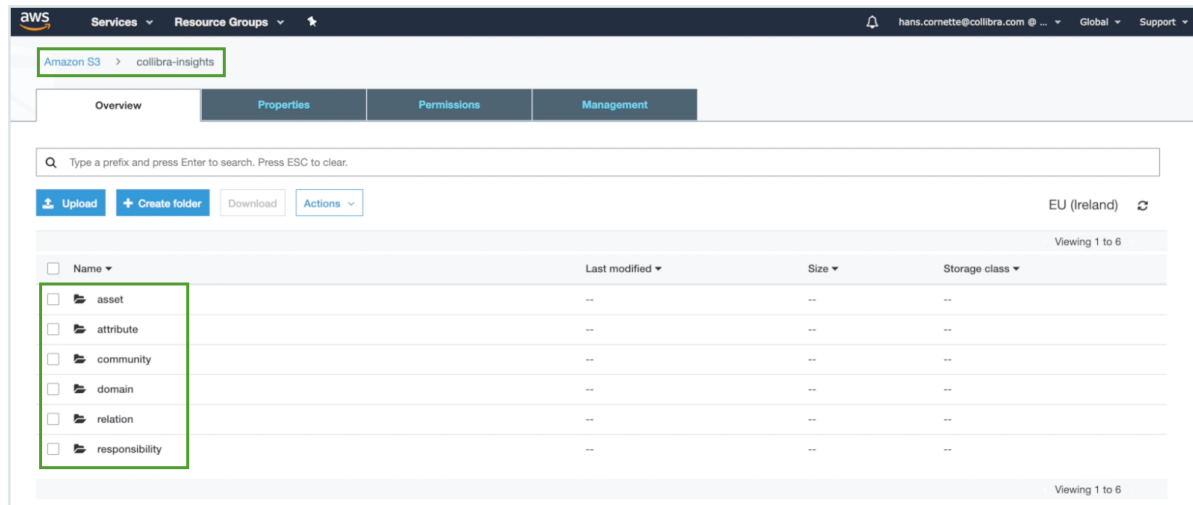

Step 3: Download the Reporting Data Layer from Collibra Marketplace

1. Go to [Collibra Marketplace](#).
2. Download the Reporting Data Layer package.
 - » A ZIP file is downloaded to your hard disk.
3. Extract the ZIP file on your local computer.
 - » A folder with the name of the ZIP file is created.

Step 4: Create the Reporting Data Layer model in AWS Athena

1. In the AWS main menu, expand the **Services** page, and then select **Athena**.
2. In the **New query** tab, enter `CREATE DATABASE <name-of-the-database>;`.
As shown in the following example image, we have created a database named "collibra_rpt".

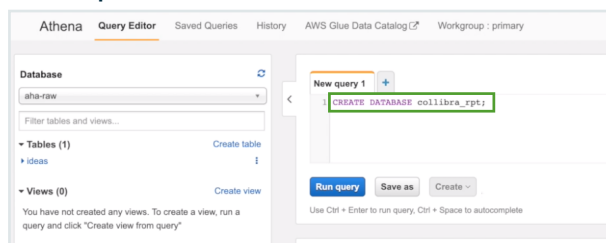

3. Click **Run query**.

- In the **Database** drop-down menu, select the database you created.

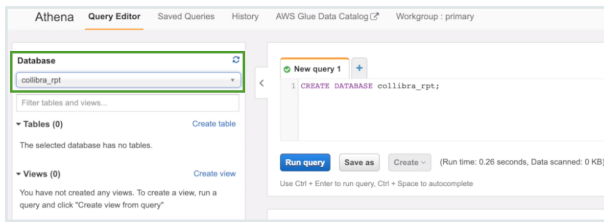

- Click the **+** button, to add another query.



- In the Reporting Data Layer ZIP file you downloaded from Collibra Marketplace, drag and drop the first SQL file into a new query tab.

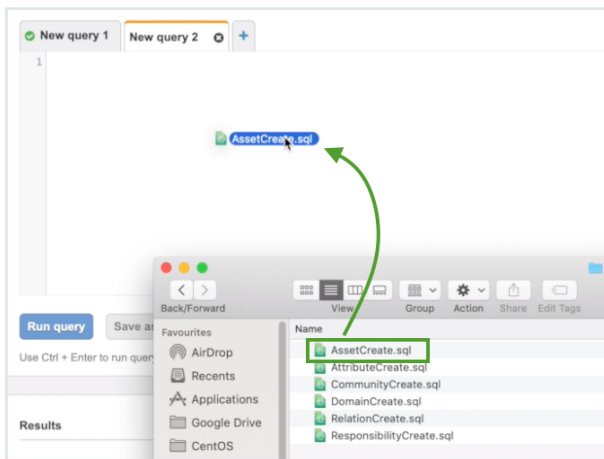

» The code appears in the query tab.

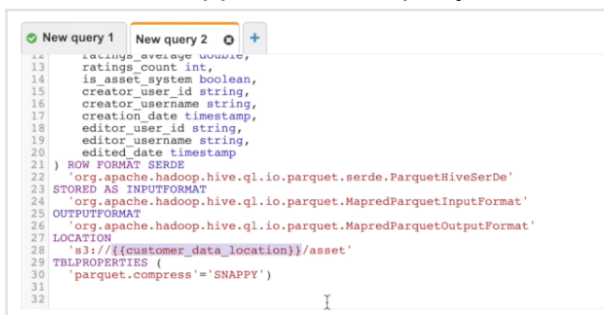

- Edit the location to the recently created bucket.

In this example, we replaced "`{{customer_data_location}}`" with *collibra-insights*.

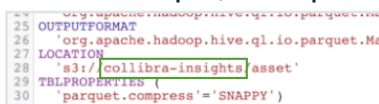

- Click **Run query**.

9. Repeat steps 5-8 for each of the SQL files in the Reporting Data Layer ZIP file.

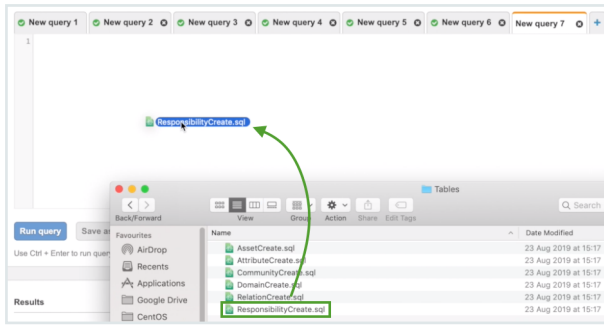

When you're done, all table definitions are shown and the Reporting Data Layer is fully configured.

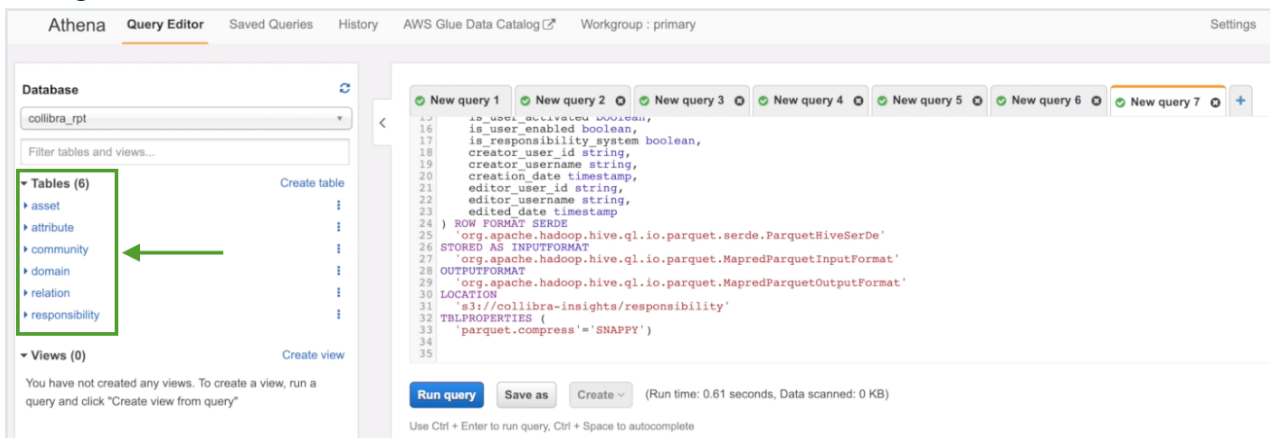

Generate dashboard reports via AWS

After creating the [Reporting Data Layer](#) on Amazon Web Services (AWS), you can generate dashboard reports that configure in Collibra Console.

Tip You can also generate dashboard reports via URL.

Prerequisites

You have:

- The Insights global role, to be able to view a report in Collibra Data Governance Center.
- [Created](#) the Reporting Data Layer on AWS.

- A license for Tableau Desktop 2018.3.
- A Tableau Server or Tableau Online account.

Steps

1. Download the report templates from [Collibra Marketplace](#)
2. Install the SQL views associated with the Tableau workbook files
3. Publish the workbook files to your Tableau Server or Tableau Online account and configure a database extract refresh schedule event
4. Configure the reporting options in Collibra DGC Settings
5. Add a dashboard in Collibra DGC and configure the Collibra Insights widget

Step 1: Download the report templates from Collibra Marketplace

1. Go to [Collibra Marketplace](#).
2. Download the following three report template packages:
 - Process Register Report Template
 - Privacy and Risk Readiness Report Template
 - Data Maturity Report Template

» The three ZIP files are downloaded to your hard disk.
3. Extract the ZIP files on your local computer.
 - » Folders with the names of the ZIP files are created. Each folder contains a SQL file and a TWBX file.

Step 2: Install the SQL views associated with the Tableau workbook files

Note

- If this is the first time you are installing the SQL views, you have to carry out this step for each of the Tableau workbook files.
- If you have previously installed the SQL views, but are now installing a new version of a report, you have to install the new SQL view, if one was provided with the new report.

1. In the AWS main menu, expand the **Services** page, and then select **Athena**.
2. In the **Database** drop-down menu, select the relevant database.

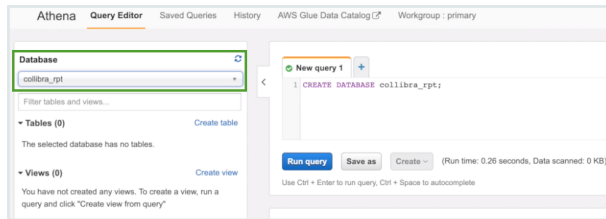

3. Click the **+** button, to add another query.



4. In one of the report template package ZIP files you downloaded from Collibra Marketplace, drag and drop the SQL file into a new query tab.

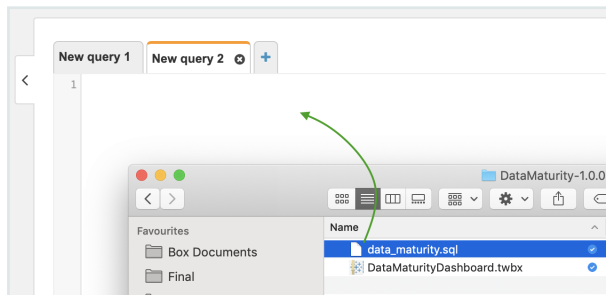

» The code appears in the query tab.



5. Click **Run query**.
6. Repeat steps 3-5 for the SQL files in the other two report template packages.

Step 3: Publish the workbook files to your Tableau Server or Online account and configure a refresh schedule event

1. On your hard drive, go to the folder of one of the report templates you downloaded from Collibra Marketplace, for example DataMaturity.
2. Open the Tableau Workbook file, in this example DataMaturityDashboard.twbx.
3. If the following warning appears, click **Yes**.



4. Do one of the following:
 - o If the following dialog box appears, click **Edit connection**.

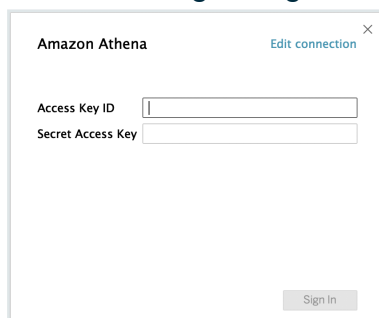

- If, instead, the Tableau dashboard is shown, click the **Data Source** tab in the lower-left corner of the page.

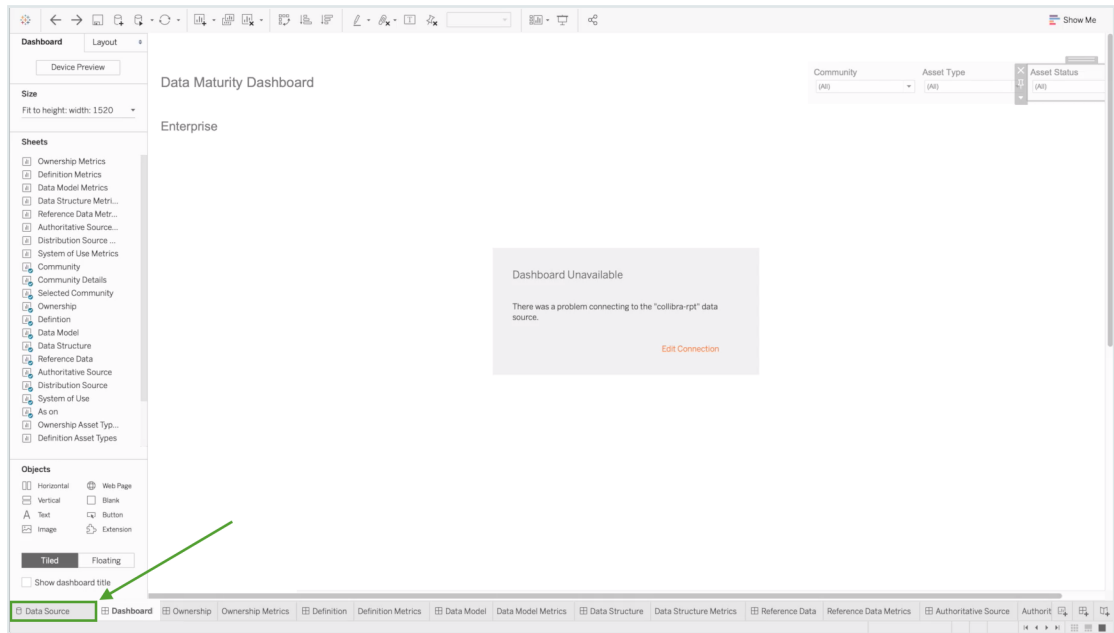

5. Enter the information specific to your AWS server.

Amazon Athena ✕

Server: Port:

S3 Staging Directory:

Enter information to sign in to the server:

Access Key ID:

Secret Access Key:

Initial SQL... Sign In

6. Click **Sign in**.

Note If you receive an error at this point, it could be that the data source "collibra_rpt" is not configured. In this case, you should edit the connection details to point to the data source you've created.

7. In the upper-right corner of the page, select an **Extract** connection.



8. In the lower-left corner of the page, click the **Dashboard** tab.
9. In the **Save As** dialog box, enter a name for the database extract file.

10. Click **Save**.
 - » The extract file is saved and a database extract is cached. This can take several minutes to complete.
11. When the dashboard is loaded, click  or **File > Save**, to save the database extract.
12. In the main menu, click **Server** and then click **Sign In**.

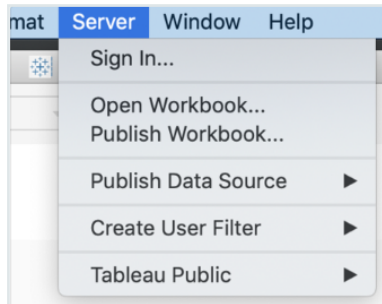

13. In the **Tableau Server Sign in** dialog box, click **Connect**.



14. Enter your Tableau sign in credentials.
15. Select the site to which you want to publish the Tableau workbook.



16. Click **Server** and then select **Publish Workbook**.

» The following dialog box appears.

17. Enter the required information.

The following fields are of interest for this task:

Property	Description
Project	The project to which you want to publish.
Name	The name of the workbook.
Refresh Schedule (Full Extract)	<p>The frequency with which the currently cached database extract is purged, and a new extract is cached.</p> <p>Tip We recommend that you schedule a daily refresh.</p>
Sheets	<p>Allows you to specify which sheets to include in the publication. You can hide sheets if you want to publish a dashboard without showing all the worksheets that were used to create it.</p> <p>Tip To avoid clutter, we recommend that you click Edit and then click Only Dashboards.</p>

Property	Description
Data Sources	<p>Determines:</p> <ul style="list-style-type: none"> ◦ Whether the data is embedded in the workbook or published separately. ◦ How users authenticate with data sources. <p>Tip We strongly recommend the following settings. Click Edit and then:</p> <ul style="list-style-type: none"> ◦ In the Publish Type drop-down menu, select Embedded in workbook. This enables users to view the report without having to authenticate themselves every time. ◦ In the Authentication drop-down menu, select Allow refresh access. This automatically refreshes the extract of the database. The frequency with which the cache is refreshed is determined by the value you enter in the Refresh Schedule field.
More options	<p>Additional publication options. The "Include external files" determines whether or not external files are included in the publication.</p> <p>Note Only the DataMaturityDashboard.twbx file refers to external files. The Include external files option will not be available for the other Tableau workbook files.</p> <p>Tip Ensure that the Include external files is selected, so that the images we've included with the Tableau workbook files are included in the publication.</p>

18. Click **Publish**.

- » The report is published to your Tableau Server or Online account.

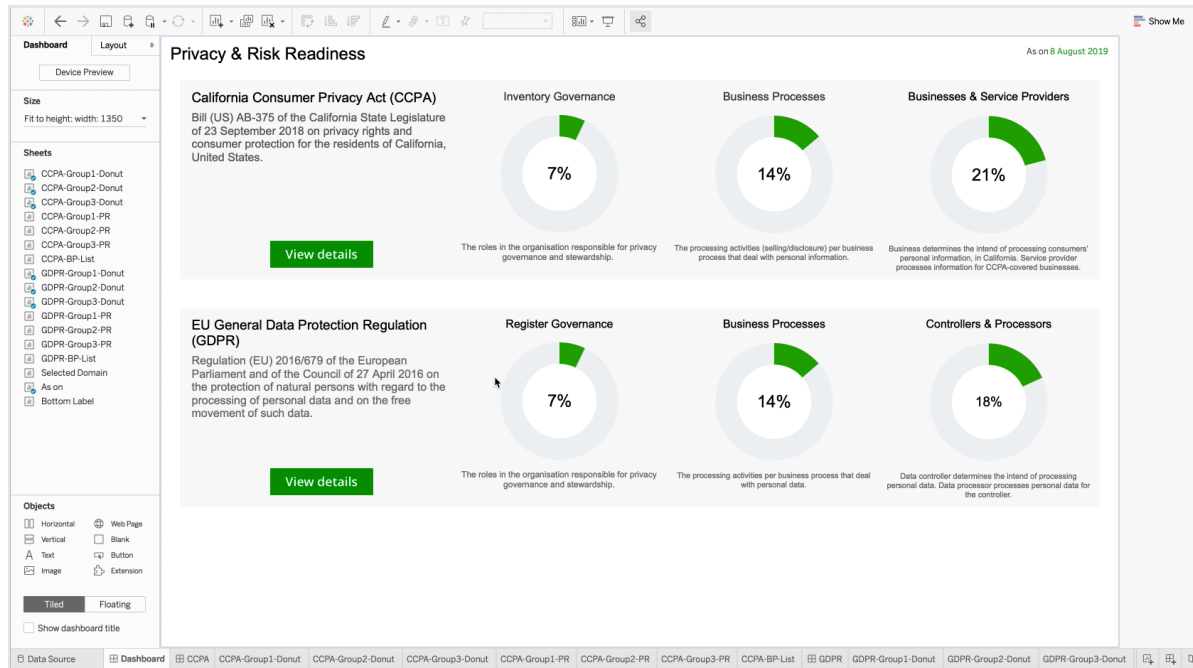

Tip In the Refresh Schedules tab, you can see the refresh schedule event you configured.

Created 1 extract refresh.

Data Maturity Dashboard
WORKBOOK • By Admin • 305 views • ☆ 0 • Extract: 30 Jul 2019, 16:55

Views 9 | Data sources 1 | **Refresh Schedules 1** | Subscriptions 0 | Details

Refresh type	Schedule	Priority	Last update	Next update
<input type="checkbox"/> Full refresh	Weekday early mornings – Weekly at 06:00 on Monday, Tuesday, Wednesday, Thursday, and Friday	50	Never	27 Aug 2019, 06:00

Step 4: Configure the reporting options in Collibra DGC Settings

1. On the **Workbooks** tab in Tableau, click one of the workbook files, for example **Privacy & Risk Readiness**.

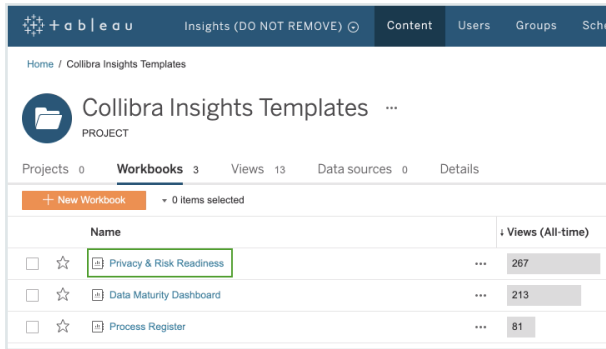

2. Click Dashboard.

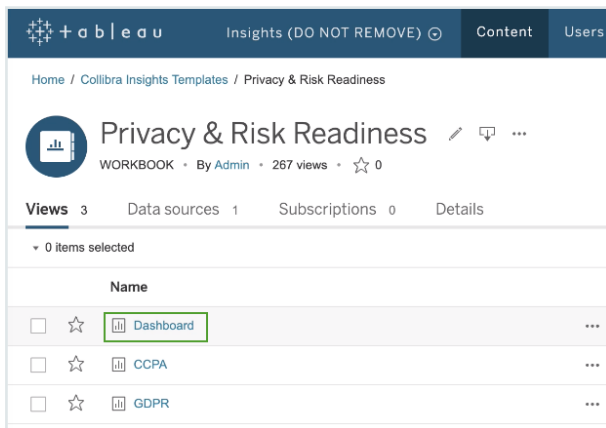

3. Click Share.

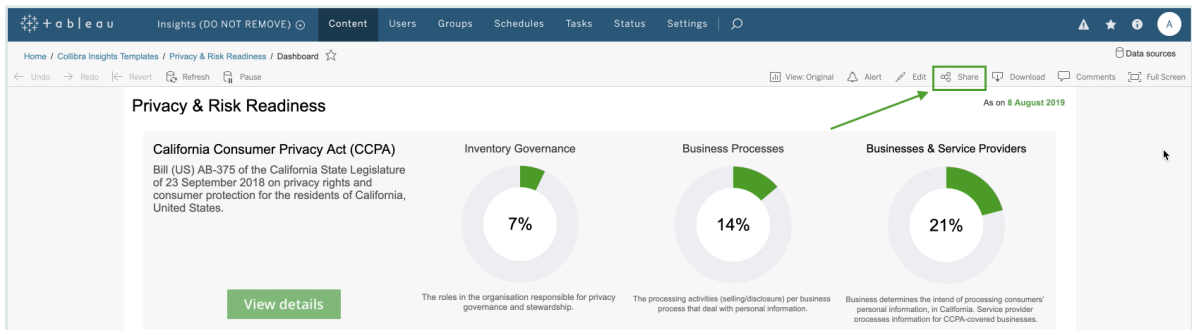

4. In the **Share** dialog box, copy the URL in the **Link** field.

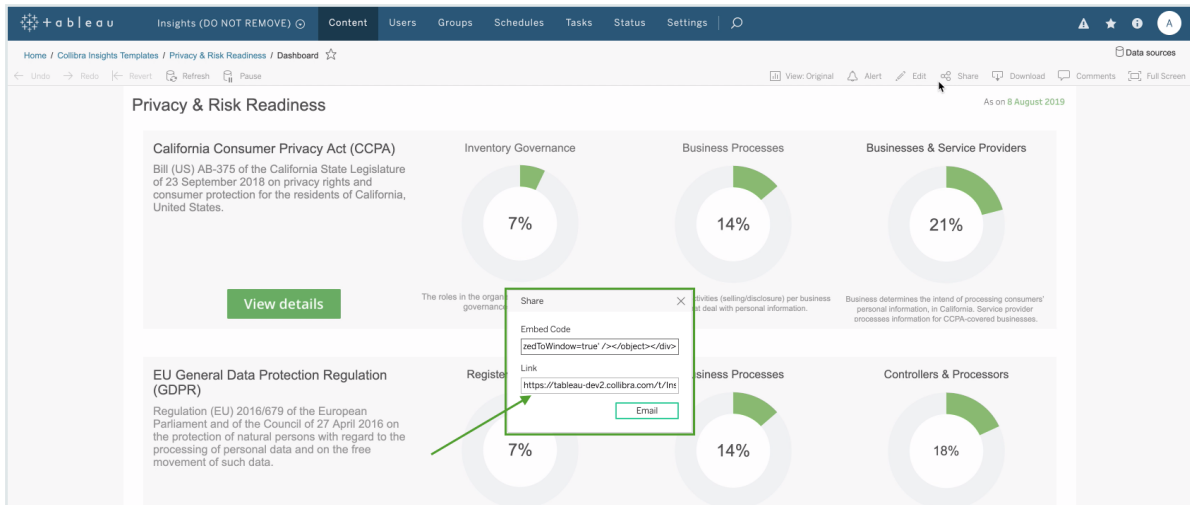

5. Open Collibra Console with a user profile that has at least the **ADMIN** role.
 - » Collibra Console opens with the **Infrastructure** page.
6. In the tab pane, click the Data Governance Center service of a Collibra DGC environment.
 - » The details of the DGC service are shown.
7. Click **Configuration**.
8. Click **Edit configuration**.
9. Scroll down the list of configuration options and click **Reporting**.

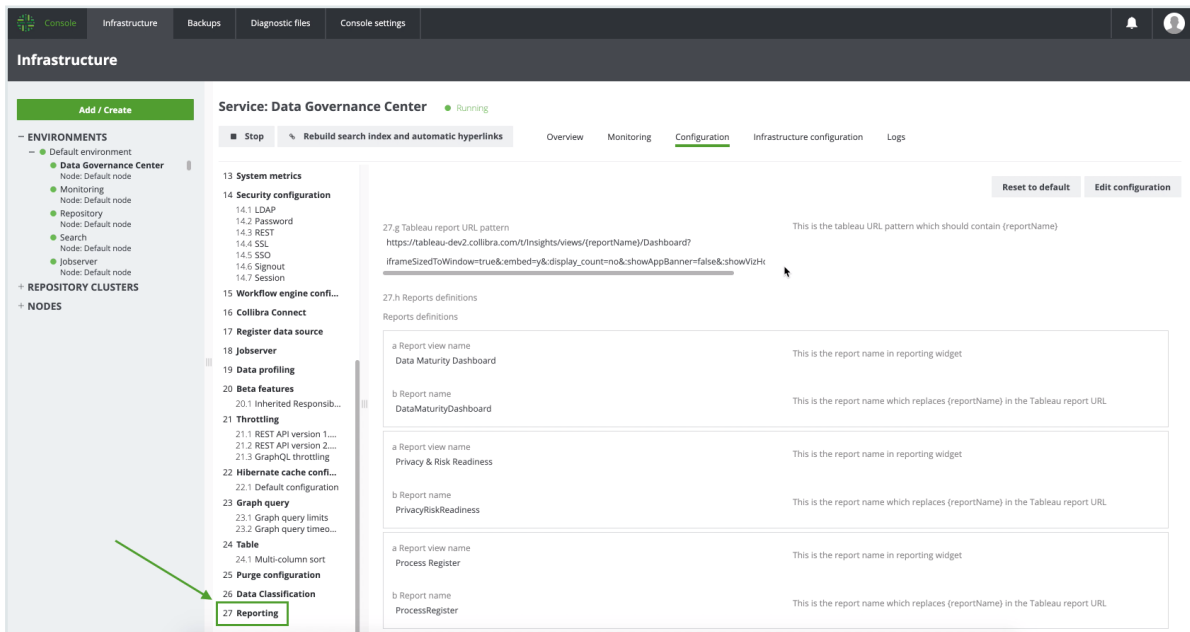

10. In field **Tableau report URL pattern**, paste the URL that you copied from the **Link** field in Tableau.

27.g Tableau report URL pattern	This is the tableau URL pattern which should contain {reportName}
<pre>https://tableau-dev2.collibra.com/t/Insights/views/{reportName}/Dashboard? iframeSizedToWindow=true&embed=y&:display_count=no&:showAppBanner=false&:showVizHc</pre>	

11. In the URL, replace the actual report name (such as *DataMaturityDashboard*) by *{reportName}*, for example:
`https://tableau-dev2.<your-Collibra-Data-Intelligence-Cloud-environment-URL>/t/Insights/views/{reportName}/iframeSizedToWindow=true&...`
12. Under **Reports definitions**, click **Add**.

Note You have to carry out this step for all three reports.

- In field **a Report view name**, enter the name of a report, as you want it to appear on the report button in the Collibra Insights widget, for example:

- Data Maturity Dashboard
- Privacy & Risk Readiness
- Process Register

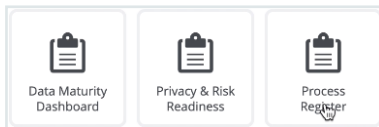

- In field **b Report name**, enter the report name, for example:

- DataMaturityDashboard
- PrivacyRiskReadiness
- ProcessRegister

Tip Use the name as it appears in the URL of the Tableau report, for example "DataMaturityDashboard".

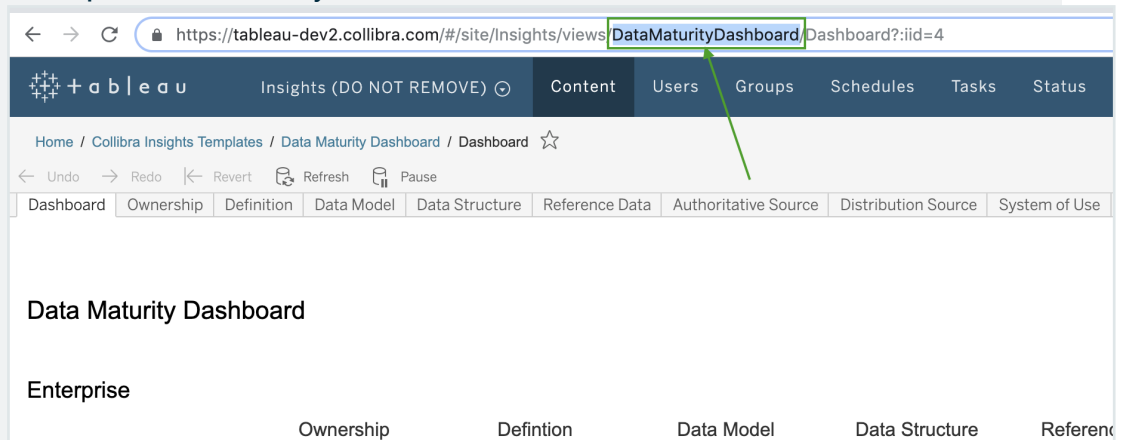

The settings in Console should look similar to the following example image:

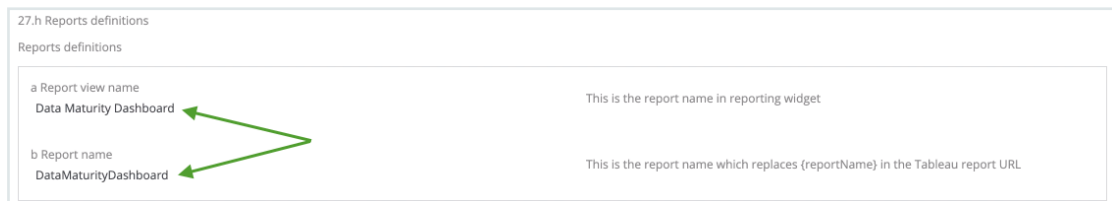

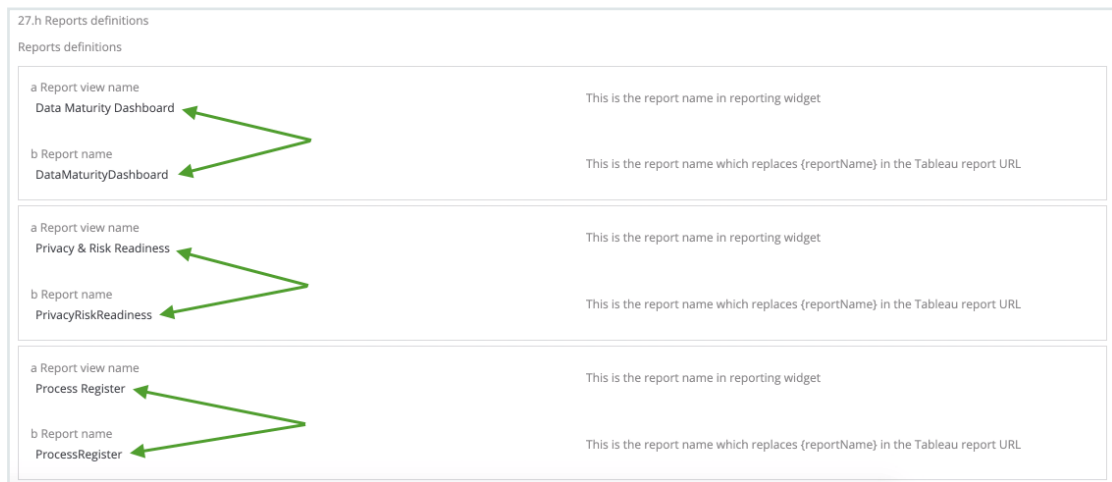

- Click **Add**, and then add the report definitions for the remaining two reports.



13. Click **Save all**.

Step 5: Add a dashboard in Collibra DGC and configure the Collibra Insights widget

Tip To facilitate the viewing of each report, we recommend that you add and configure a separate dashboard for each report. To do so, you have to complete this step for each report.

1. In the Collibra DGC main menu, click  → **Dashboards**.
2. In the view bar, click  → **Add Dashboard**.
3. Enter the required information.

Property	Description
Name	The name of your new dashboard.
Description	A description of the dashboard (optional).
Layout	The number of columns in the layout of the dashboard. Tip Ensure that 1 column is selected.
Always visible in the toolbar.	Option to always show the dashboard in the toolbar.

4. Click **Save**.
5. In the view bar, click  → **Edit widgets**.
6. Find the Collibra Insights widget and drag it onto the dashboard.

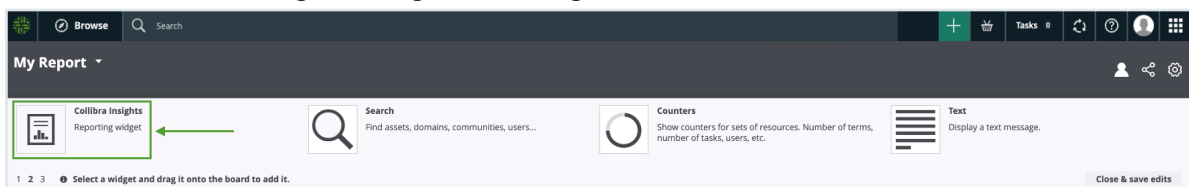

» The three reports that you configured in Collibra DGC Settings are shown:

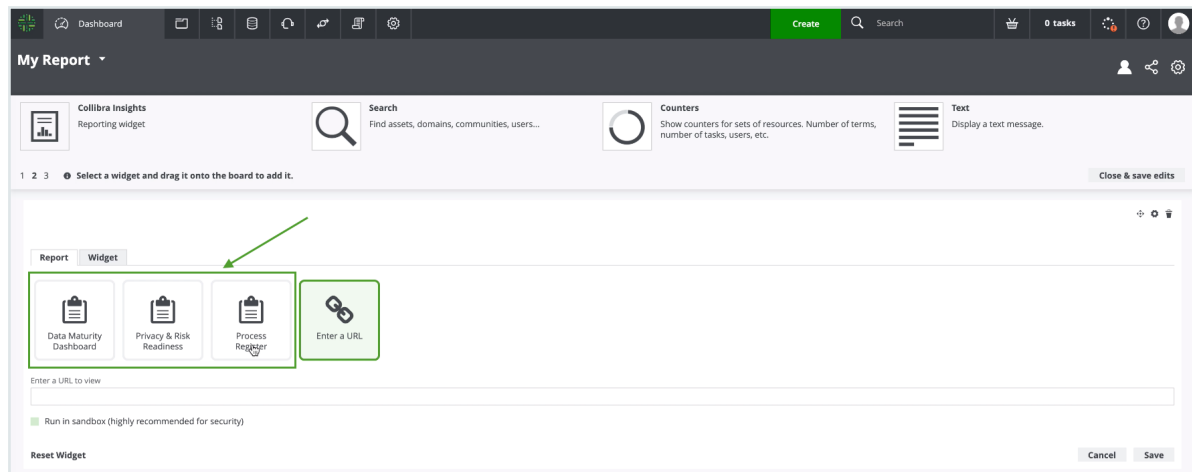

7. Select the report you want to show on the dashboard.
8. Click **Save**.
 - » The report is shown on the dashboard you created.

What's next?

Optionally, you can:

- [Remove](#) non-applicable regulation placeholder.
- [Improve](#) the visual output of the Data Maturity report.

Generate a dashboard report via URL on AWS

After creating the [Reporting Data Layer](#) on Amazon Web Services, you can generate a dashboard report via a URL, from tools such as Tableau Online, Power BI, Qlik, or ThoughtSpot.

Prerequisites

You have:

- The Insights global role, to be able to view a report in Collibra Data Governance Center.
- [Created](#) the Reporting Data Layer on AWS.
- A license for Tableau Desktop 2018.3.
- A Tableau Server or Tableau Online account.

Steps

1. Download the report templates from [Collibra Marketplace](#)
2. Install the SQL views associated with the Tableau workbook files
3. Publish the workbook files to your Tableau Server or Tableau Online account and configure a database extract refresh schedule event
4. Obtain the shareable link
5. Add a dashboard in Collibra DGC and add your report via URL

Step 1: Download the report templates from Collibra Marketplace

1. Go to [Collibra Marketplace](#).
2. Download the following three report template packages:
 - Process Register Report Template
 - Privacy and Risk Readiness Report Template
 - Data Maturity Report Template
 - » The three ZIP files are downloaded to your hard disk.
3. Extract the ZIP files on your local computer.
 - » Folders with the names of the ZIP files are created. Each folder contains a SQL file and a TWBX file.

Step 2: Install the SQL views associated with the Tableau workbook files

Note

- If this is the first time you are installing the SQL views, you have to carry out this step for each of the Tableau workbook files.
- If you have previously installed the SQL views, but are now installing a new version of a report, you have to install the new SQL view, if one was provided with the new report.

1. In the AWS main menu, expand the **Services** page, and then select **Athena**.
2. In the **Database** drop-down menu, select the relevant database.

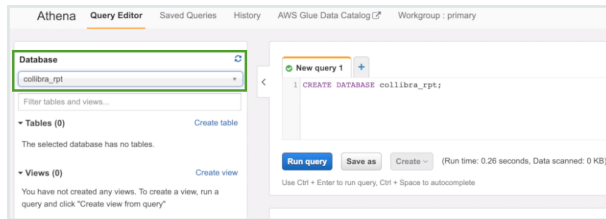

3. Click the **+** button, to add another query.



4. In one of the report template package ZIP files you downloaded from Collibra Marketplace, drag and drop the SQL file into a new query tab.

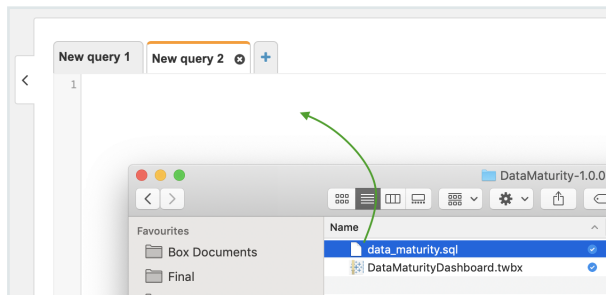

» The code appears in the query tab.



5. Click **Run query**.
6. Repeat steps 3-5 for the SQL files in the other two report template packages.

Step 3: Publish the workbook files to your Tableau Server or Online account and configure a refresh schedule event

1. On your hard drive, go to the folder of one of the report templates you downloaded from Collibra Marketplace, for example DataMaturity.
2. Open the Tableau Workbook file, in this example DataMaturityDashboard.twbx.
3. If the following warning appears, click **Yes**.

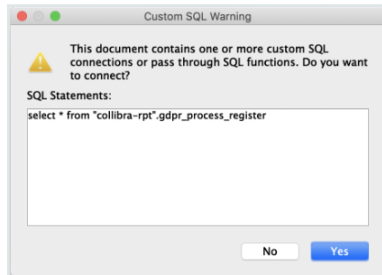

4. Do one of the following:
 - o If the following dialog box appears, click **Edit connection**.

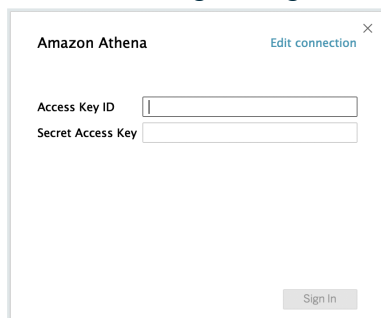

- If, instead, the Tableau dashboard is shown, click the **Data Source** tab in the lower-left corner of the page.

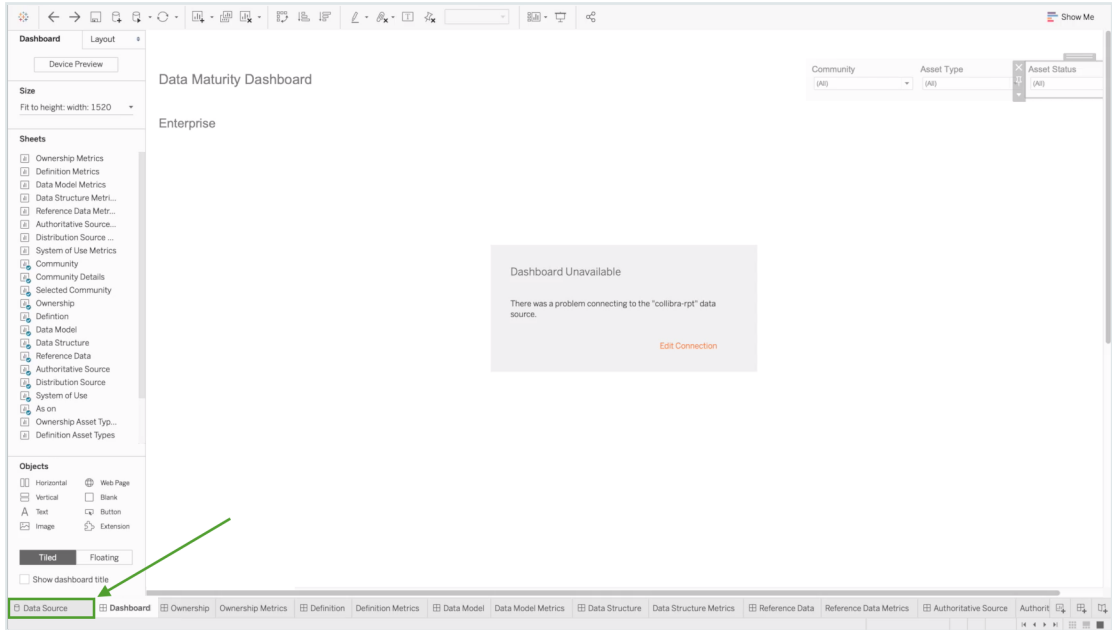

5. Enter the information specific to your AWS server.

Amazon Athena ✕

Server: Port:

S3 Staging Directory:

Enter information to sign in to the server:

Access Key ID:

Secret Access Key:

Initial SQL... Sign In

6. Click **Sign in**.

Note If you receive an error at this point, it could be that the data source "collibra_rpt" is not configured. In this case, you should edit the connection details to point to the data source you've created.

7. In the upper-right corner of the page, select an **Extract** connection.



8. In the lower-left corner of the page, click the **Dashboard** tab.
9. In the **Save As** dialog box, enter a name for the database extract file.

10. Click **Save**.
 - » The extract file is saved and a database extract is cached. This can take several minutes to complete.
11. When the dashboard is loaded, click  or **File > Save**, to save the database extract.
12. In the main menu, click **Server** and then click **Sign In**.

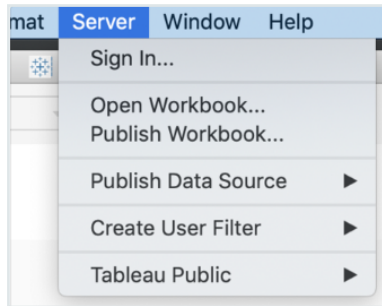

13. In the **Tableau Server Sign in** dialog box, click **Connect**.



14. Enter your Tableau sign in credentials.
15. Select the site to which you want to publish the Tableau workbook.



16. Click **Server** and then select **Publish Workbook**.
 » The following dialog box appears.

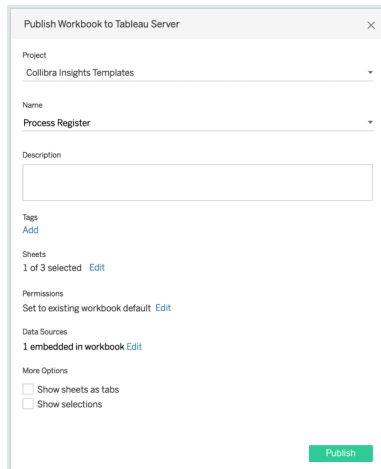

17. Enter the required information.
 The following fields are of interest for this task:

Property	Description
Project	The project to which you want to publish.
Name	The name of the workbook.
Refresh Schedule (Full Extract)	<p>The frequency with which the currently cached database extract is purged, and a new extract is cached.</p> <p>Tip We recommend that you schedule a daily refresh.</p>
Sheets	<p>Allows you to specify which sheets to include in the publication. You can hide sheets if you want to publish a dashboard without showing all the worksheets that were used to create it.</p> <p>Tip To avoid clutter, we recommend that you click Edit and then click Only Dashboards.</p>

Property	Description
Data Sources	<p>Determines:</p> <ul style="list-style-type: none"> ◦ Whether the data is embedded in the workbook or published separately. ◦ How users authenticate with data sources. <p>Tip We strongly recommend the following settings. Click Edit and then:</p> <ul style="list-style-type: none"> ◦ In the Publish Type drop-down menu, select Embedded in workbook. This enables users to view the report without having to authenticate themselves every time. ◦ In the Authentication drop-down menu, select Allow refresh access. This automatically refreshes the extract of the database. The frequency with which the cache is refreshed is determined by the value you enter in the Refresh Schedule field.
More options	<p>Additional publication options. The "Include external files" determines whether or not external files are included in the publication.</p> <p>Note Only the DataMaturityDashboard.twbx file refers to external files. The Include external files option will not be available for the other Tableau workbook files.</p> <p>Tip Ensure that the Include external files is selected, so that the images we've included with the Tableau workbook files are included in the publication.</p>

18. Click **Publish**.

- » The report is published to your Tableau Server or Online account.

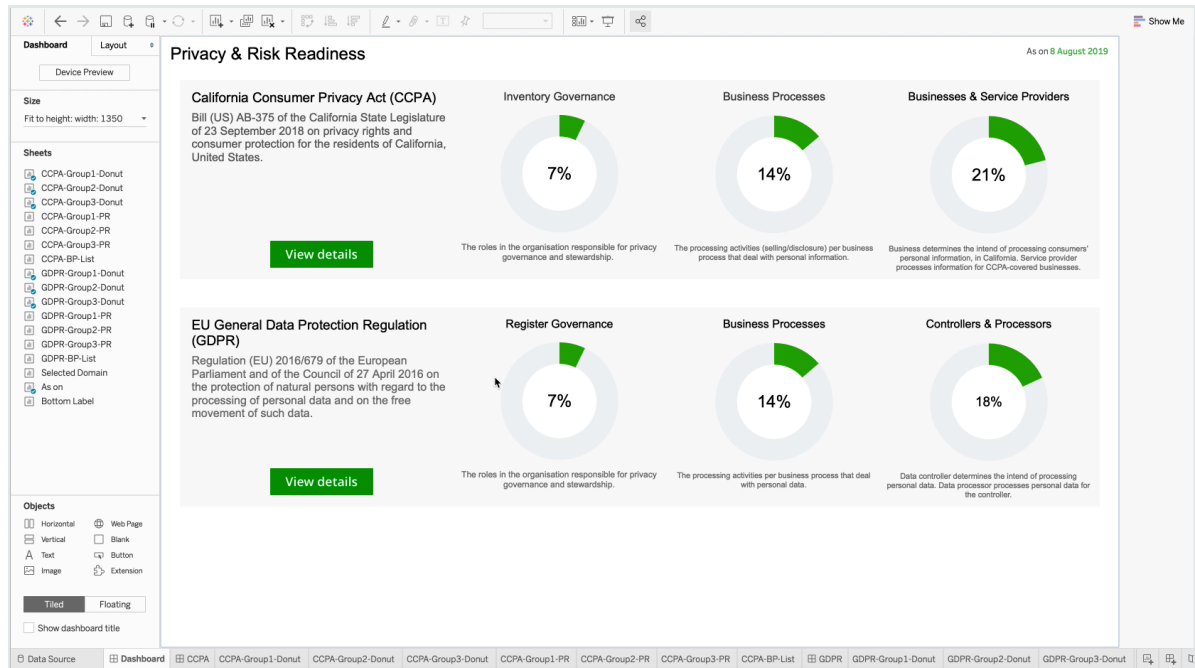

Tip In the Refresh Schedules tab, you can see the refresh schedule event you configured.

Home / Colibra Insights Templates / Data Maturity Dashboard

Data Maturity Dashboard WORKBOOK • By Admin • 305 views • ☆ 0 • Extract: 30 Jul 2019, 16:55

Views 9 | Data sources 1 | **Refresh Schedules 1** | Subscriptions 0 | Details

+ New Extract Refresh | 0 items selected

Refresh type	Schedule	Priority	Last update	Next update
<input type="checkbox"/> Full refresh	Weekday early mornings – Weekly at 06:00 on Monday, Tuesday, Wednesday, Thursday, and Friday	50	Never	27 Aug 2019, 06:00

Step 4: Obtain the shareable link

1. On the **Workbooks** tab in Tableau, click one of the workbook files, for example **Privacy & Risk Readiness**.

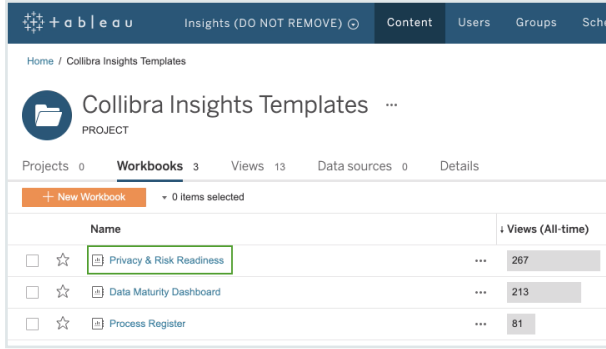

2. Click Dashboard.

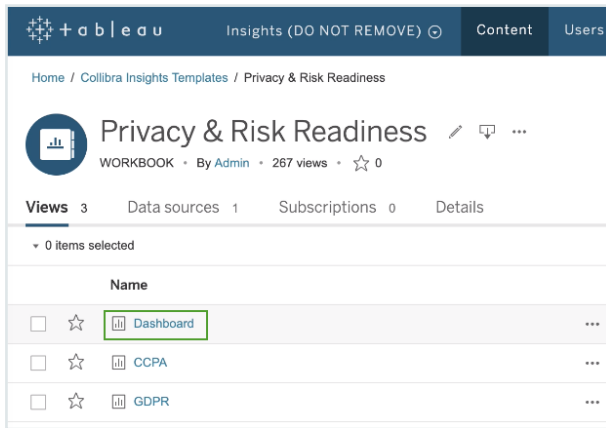

3. Click Share.

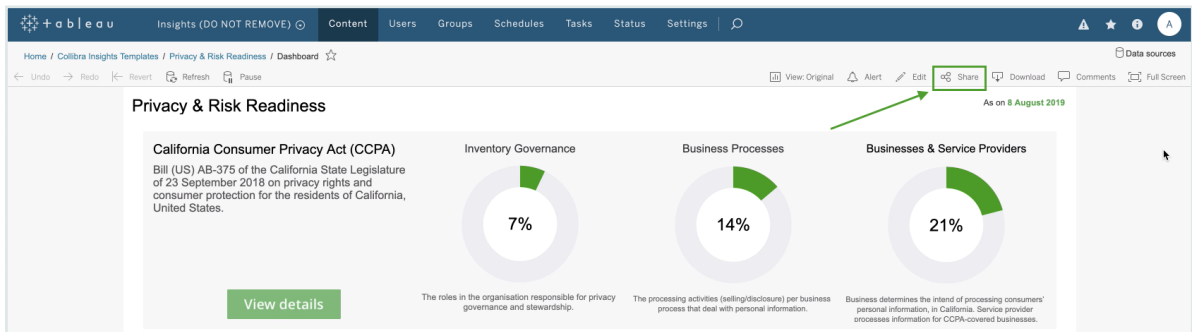

4. In the **Share** dialog box, copy the URL in the **Link** field.

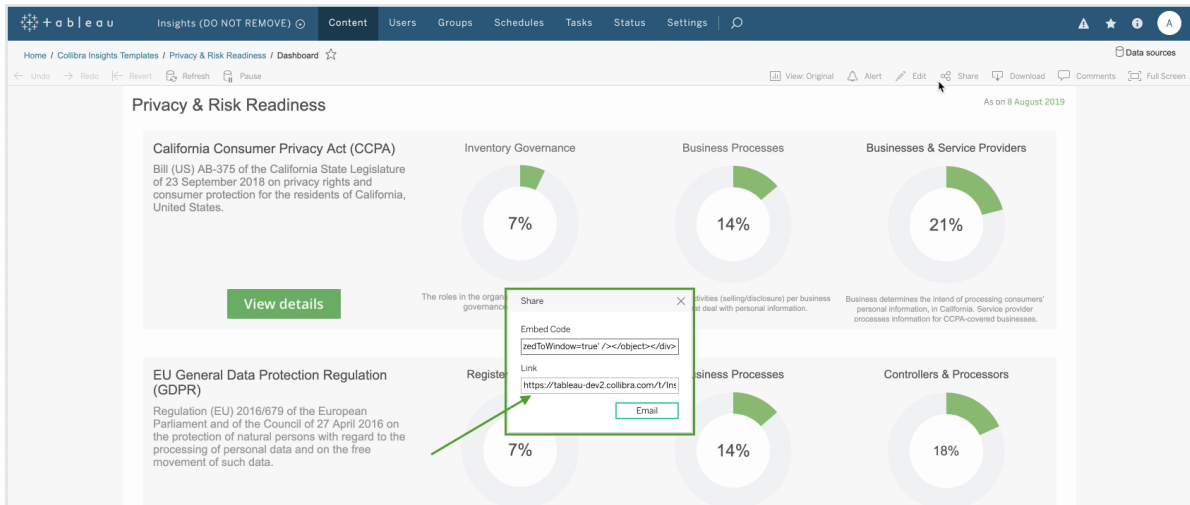

Step 5: Add a dashboard in Collibra DGC and then add your report via URL

Tip To facilitate the viewing of each report, we recommend that you add and configure a separate dashboard for each report. To do so, you have to complete this step for each report.

1. In the Collibra DGC main menu, click → **Dashboards**.
2. In the view bar, click → **Add Dashboard**.
3. Enter the required information.

Property	Description
Name	The name of your new dashboard.
Description	A description of the dashboard (optional).
Layout	The number of columns in the layout of the dashboard.
	<p>Tip Ensure that 1 column is selected.</p>

Property	Description
Always visible in the toolbar.	Option to always show the dashboard in the toolbar.

4. Click **Save**.
5. In the view bar, click  → **Edit widgets**.
6. Find the Collibra Insights widget and drag it onto the dashboard.

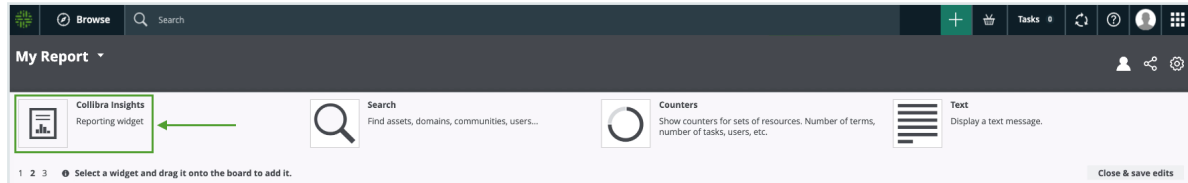

7. Click Enter a URL, and enter the relevant URL.

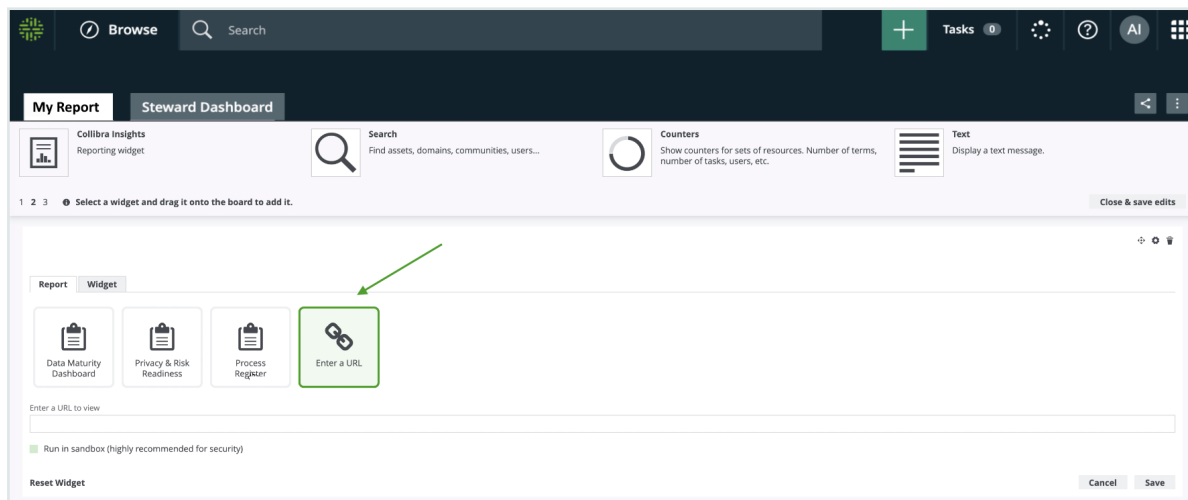

8. Click **Save**.
 - » The report is shown on the dashboard you created.

What's next?

Optionally, you can:

- **Remove** non-applicable regulation placeholder.
- **Improve** the visual output of the Data Maturity report.

Creating the Reporting Data Layer on GCP and generating reports

Before configuring the [dashboard reports](#), you have to create the [Reporting Data Layer](#) on Google Cloud Platform (GCP). You can then create your dashboard reports via Collibra Console or URL.

In this chapter

Create the Reporting Data Layer on GCP

This section provides information on how to create the [Reporting Data Layer](#) on Google Cloud Platform (GCP), with Google Cloud Storage and Google BigQuery. You can, however, use alternative software. We also provide documentation on how to [create the Reporting Data Layer on Amazon Web Services](#).

Prerequisites

You have:

- A license for Collibra Insights.
- Collibra Data Intelligence Cloud 5.7 or newer.
- Software for working with Parquet files.

Steps

1. [Download a data snapshot from your Collibra DGC environment](#)
2. [Upload the data to a Google Cloud Storage bucket](#)
3. [Create the Reporting Data Layer model in Google BigQuery](#)

Step 1: Download a data snapshot from your Collibra DGC environment

1. Enter the following URL in your browser:
`<your-DGC-environment-URL>/rest/2.0/reporting/insights/download?snapshotDate=<snapshot_date>&format=zip`, where `<snapshot date>` is the date from which you want the data, formatted as YYYY-MM-DD, for example "2019-07-23".
 - » A ZIP file of the data from your Collibra DGC environment, for the specified date, is downloaded to your hard disk.
2. Extract the ZIP files on your local computer.
 - » A folder with the name of the ZIP file is created.

Step 2: Upload the data to a Google Cloud Storage bucket

Note This only needs to be done once for the collection Tableau workbook files. After that, you only need to carry out this step if the data layer model changes.

1. Sign in to your GCP account and choose your working project for Insights deployment.

Tip We recommend that you create a separate project for Insights deployment.

2. In the tab menu, click the **Storage** tab and then click **Cloud Storage**.
3. In the **Browser** tab, click **Create bucket**.

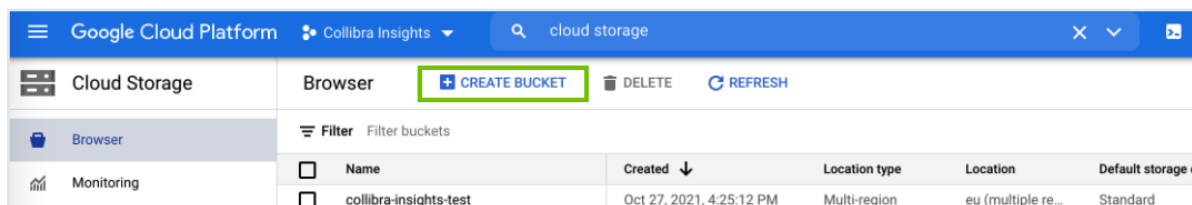

- » The **Create a bucket** dialog box appears.
4. In the **Name your bucket** field, enter a name for the bucket you are creating, for example "collibra-insights".
 5. Click **Continue**.

6. In the **Choose where to store your data** section, enter the relevant values, for example:

- Location type: *Multi-region*
- Location: *Your geographic location*

Tip Consult your IT department for help with the correct values for your Collibra DGC environment configuration and to ensure compliance with your company policies.

7. Click **Continue**.
8. In the **Choose a default storage class for your data** section, click **Standard**.
9. Click **Continue**.
10. in the **Choose how to control access to objects** section, enter the relevant values, for example:

- Access control: *Uniform*

Tip Consult your IT department for help with the correct values for your Collibra DGC environment configuration and to ensure compliance with your company policies.

11. Click **Continue**.
12. in the **Choose how to protect object data** section, enter the relevant values, for example:

- Protection tool: *None*

Tip Consult your IT department for help with the correct values for your Collibra DGC environment configuration and to ensure compliance with your company policies.

13. Click **Create**.
 - » The bucket is created.
14. In the **Browse** tab, search for your newly created bucket, and then click it.

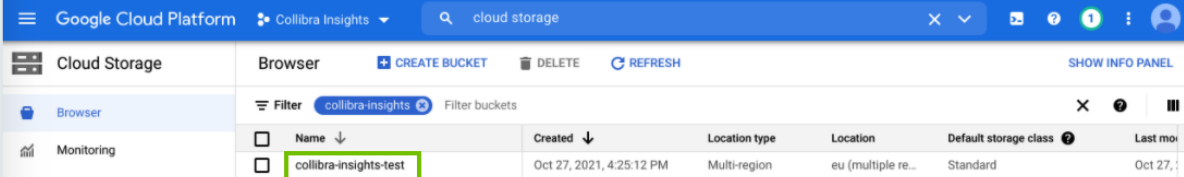

Name	Created	Location type	Location	Default storage class	Last modified
collibra-insights-test	Oct 27, 2021, 4:25:12 PM	Multi-region	eu (multiple re...	Standard	Oct 27, ...

- » The bucket details page opens.

15. Click **Upload Folder**, to upload the data you downloaded from your Collibra DGC environment.

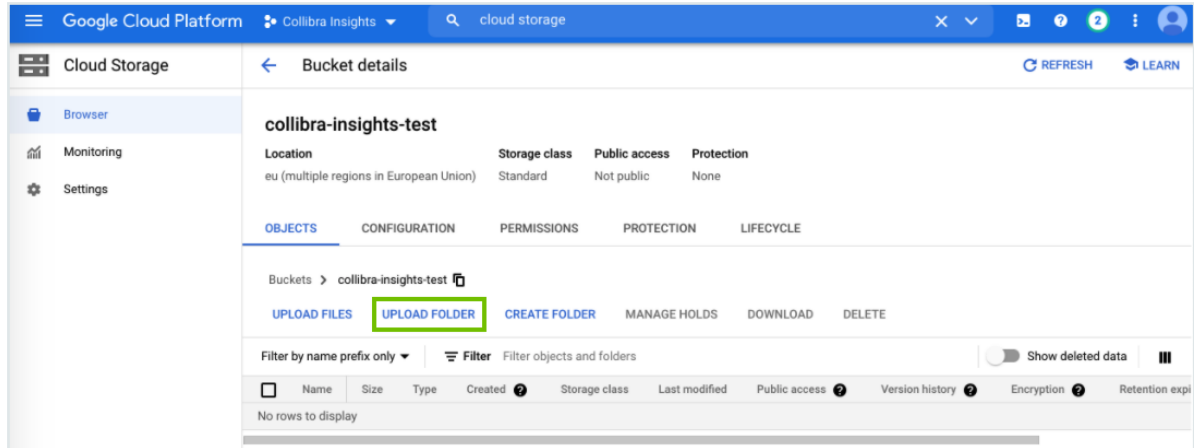

» The **Upload** dialog box appears.

16. In the **Upload** dialog box, find the unpacked folders of the ZIP file you downloaded from your Collibra DGC environment. As shown in the following image, there are eight folders to be uploaded.



17. Select a folder, for example "complex_relation", and then click **Upload**.

Note You can only select one folder at a time.

18. Repeat steps 15-17, until you have uploaded all eight folders.
 » The folders are added to the newly created bucket.

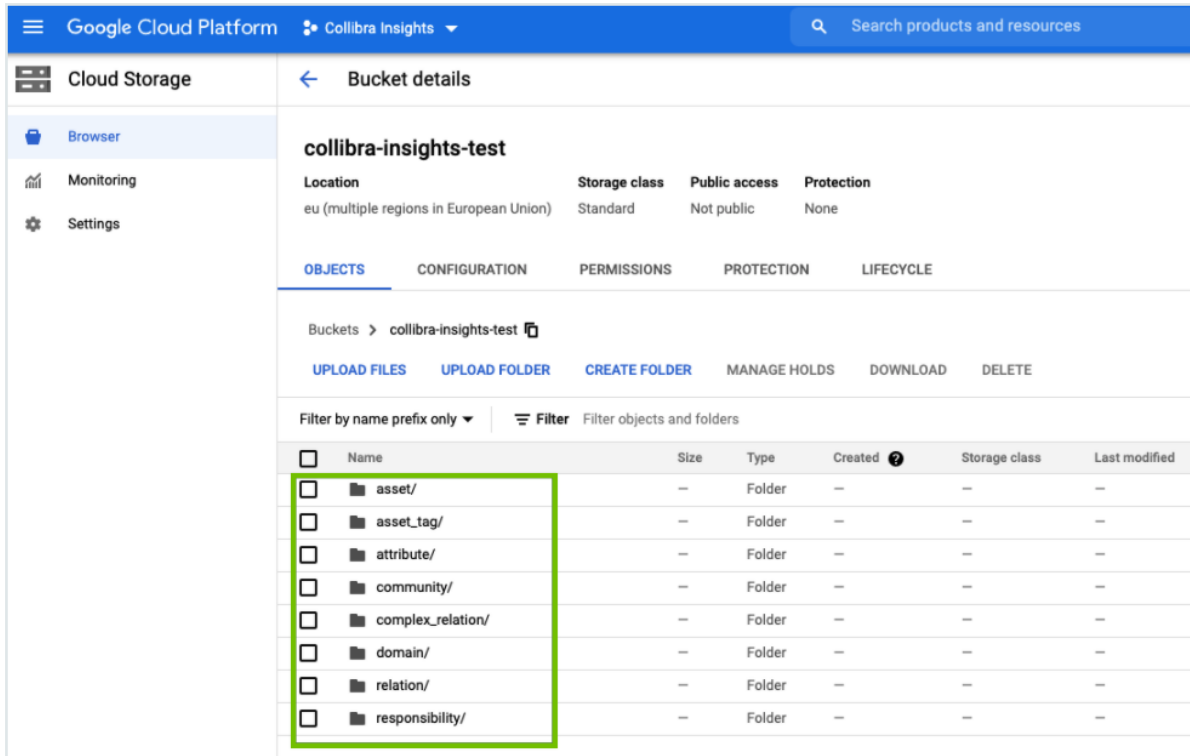

Step 3: Create the Reporting Data Layer model in Google BigQuery

Tip The objective of steps 6-8 in the following procedure can also be achieved by using a [Cloud shell command](#).

1. In the left tab menu, in the **BIG DATA** section, click **BigQuery**.
2. On the **Explorer** page, find your Insights project, and then click **> Create dataset**.

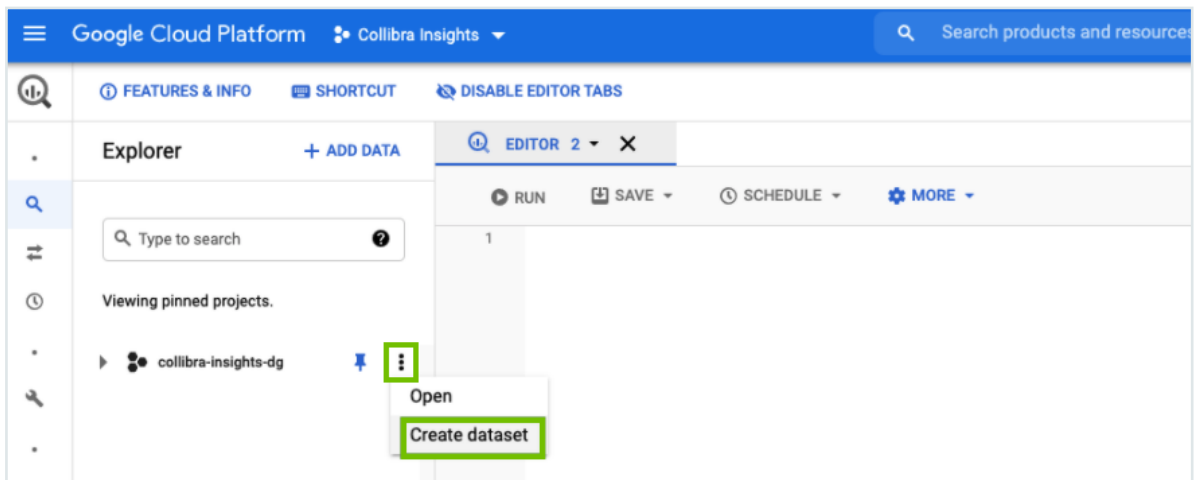

3. In the **Create dataset** side panel, enter the relevant information:

Create dataset

Dataset ID *

Letters, numbers, and underscores allowed

Data location
 ▼ ?

Default table expiration

Enable table expiration ?

Default maximum table age Days

Encryption

Google-managed encryption key
No configuration required

Customer-managed encryption key (CMEK)
Manage via Google Cloud Key Management Service

Field	Description
Dataset ID	A unique name for your dataset.
Data location	<p>The geographical region of your data.</p> <div style="border-left: 2px solid #008000; padding-left: 10px; margin-top: 10px;"> <p>Tip Consult your IT department for help with the correct value for your Collibra DGC environment configuration and to ensure compliance with your company policies.</p> </div>

4. Click **Create dataset**.

- In the **Explorer** page, find your newly created dataset, and then click **Open**.
 - The dataset view page opens.

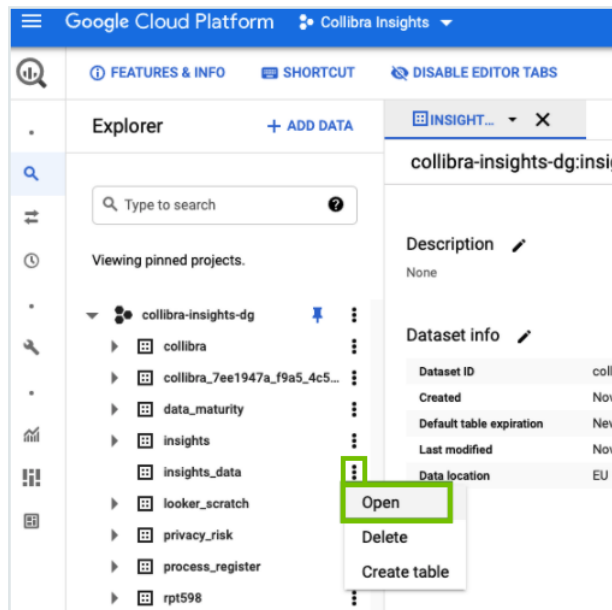

- In the dataset view page, click **Create table**.

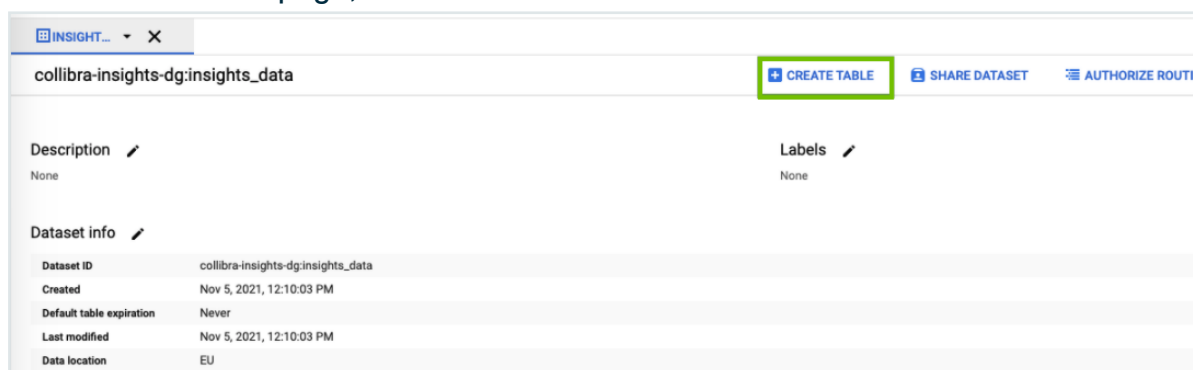

- The **Create table** side panel opens.

- In the **Create table** section, enter the relevant information:

Create table

Source

Create table from: Select file from GCS bucket:

Google Cloud Storage collibra-insights-test/asset/*.parquet Browse File format: Parquet

Source Data Partitioning

Destination

Search for a project Enter a project name

Project name: Collibra Insights Dataset name: insights_data Table type: Native table

Table name:

Field	Description
Create table from	Select Google Cloud Storage .
Select file from GCS bucket	<p>Enter <code><your-data-bucket-name>/<data type>/*.parquet</code></p> <p>The bucket name is the one you created in Step 2.4 and the data type, for example "asset", is the sub-directory location.</p> <div style="border-left: 2px solid green; padding-left: 10px; margin-top: 10px;"> <p>Tip Step 9 of this procedure prompts you to repeat steps 6-8, for each data type, for example, asset, attributes, relation, responsibility and so forth.</p> </div>
File format	Select Parquet .
Source Data Partitioning	This checkbox should be cleared.
Search for a project / Enter a project name	Select the Search for a project option.
Project name	Select the project you are using for Insights deployment.
Dataset name	Select the database name you entered in step 3.3.
Table type	Select Native table .

Field	Description
Table name	<p>Enter the data type. This must match the data type enter for the sub-directory location in the Select file from GCS bucket field.</p> <div style="border: 1px solid #ccc; padding: 10px; margin-top: 10px;"> <p>Tip Step 9 of this procedure prompts you to repeat steps 6-8, for each data type, for example, asset, attribute, relation, responsibility and so forth.</p> </div>

8. Click **Create table**.
9. Repeat steps 6-8 for each data type in the file you downloaded in step 1.1, for example, asset, relation, responsibility and so forth.

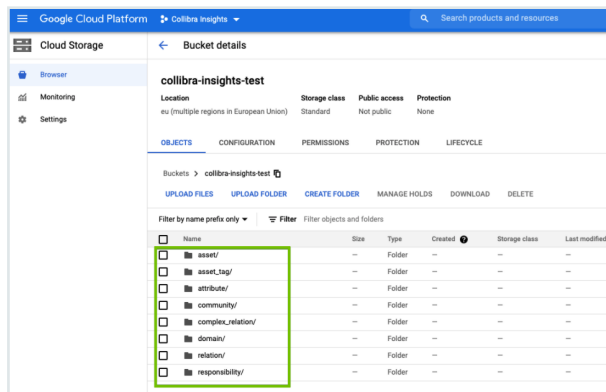

When you're done, all table definitions are shown and the Reporting Data Layer is fully configured.

The screenshot displays the Google Cloud Platform console for the 'Collibra Insights' project. The Explorer pane on the left shows a tree view of the project structure, with 'insights_data' expanded to show a list of tables: asset, asset_tag, attribute, community, complex_relation, domain, relation, and responsibility. The main pane on the right shows the details for the 'collibra-insights-dg:insights_data' dataset. The 'Dataset info' section includes the following details:

Dataset ID	collibra-insights-dg:insights_data
Created	Nov 5, 2021, 12:10:03 PM
Default table expiration	Never
Last modified	Nov 5, 2021, 12:10:03 PM
Data location	EU

Below the dataset info, there is a 'Job history' section with a 'REFRESH' button. The job history table shows the following entries:

Time	Status	Job Name
2:19 PM	✓	Load gs://collibra-insights-test/responsibility/*.parquet to collibra-insights-dg:insights_data.responsibility
2:18 PM	✓	Load gs://collibra-insights-test/relation/*.parquet to collibra-insights-dg:insights_data.relation
2:18 PM	✓	Load gs://collibra-insights-test/complex_relation/*.parquet to collibra-insights-dg:insights_data.complex_relation

Use a Cloud shell command

The objective of steps 6-8 in the previous procedure can also be achieved by using a Cloud shell command.

Run the following command, where <customer-dataset-name> and <customer-data-bucket> are replaced with the relevant values.

```
bq load \
  --noreplace \
  --source_format=PARQUET \
  <customer-dataset-name>.asset \
  gs://<customer-data-bucket>/asset/*.parquet
```

```
bq load \  
  --noreplace \  
  --source_format=PARQUET \  
  <customer-dataset-name>.asset_tag \  
  gs://<customer-data-bucket>/asset_tag/*.parquet  
  
bq load \  
  --noreplace \  
  --source_format=PARQUET \  
  customer-dataset-name>.attribute \  
  gs://<customer-data-bucket>/attribute/*.parquet  
  
bq load \  
  --noreplace \  
  --source_format=PARQUET \  
  <customer-dataset-name>.community \  
  gs://<customer-data-bucket>/community/*.parquet  
  
bq load \  
  --noreplace \  
  --source_format=PARQUET \  
  <customer-dataset-name>.complex_relation \  
  gs://<customer-data-bucket>/complex_relation/*.parquet  
  
bq load \  
  --noreplace \  
  --source_format=PARQUET \  
  <customer-dataset-name>.domain \  
  gs://<customer-data-bucket>/domain/*.parquet  
  
bq load \  
  --noreplace \  
  --source_format=PARQUET \  
  <customer-dataset-name>.relation \  
  gs://<customer-data-bucket>/relation/*.parquet  
  
bq load \  
  --noreplace \  
  --source_format=PARQUET \  
  <customer-dataset-name>.responsibility \  
  gs://<customer-data-bucket>/responsibility/*.parquet
```

Generate dashboard reports via GCP

After creating the [Reporting Data Layer](#) on Google Cloud Platform (GCP), you can generate dashboard reports that configure in Collibra Console.

Tip You can also generate dashboard reports via URL.

Prerequisites

You have:

- The Insights global role, to be able to view a report in Collibra Data Governance Center.
- [Created](#) the Reporting Data Layer on GCP.
- A license for Tableau Desktop 2018.3.
- A Tableau Server or Tableau Online account.

Steps

1. [Download the report templates from Collibra Marketplace](#)
2. [Install the SQL views associated with the Tableau workbook files](#)
3. [Publish the workbook files to your Tableau Server or Tableau Online account and configure a database extract refresh schedule event](#)
4. [Configure the reporting options in Collibra DGC Settings](#)
5. [Add a dashboard in Collibra DGC and configure the Collibra Insights widget](#)

Step 1: Download the report templates from Collibra Marketplace

1. Go to [Collibra Marketplace](#).
2. Download the following three report template packages:
 - Process Register Report Template
 - Privacy and Risk Readiness Report Template
 - Data Maturity Report Template» The three ZIP files are downloaded to your hard disk.
3. Extract the ZIP files on your local computer.
 - » Folders with the names of the ZIP files are created. Each folder contains a SQL file and a TWBX file.

Step 2: Install the SQL views associated with the Tableau workbook files

Note

- If this is the first time you are installing the SQL views, you have to carry out this step for each of the Tableau workbook files.
- If you have previously installed the SQL views, but are now installing a new version of a report, you have to install the new SQL view, if one was provided with the new report.

1. In the **BIG DATA** section of the GCP left-hand menu, click **BigQuery**.
2. In the **Explorer** page, click **COMPOSE NEW QUERY**.

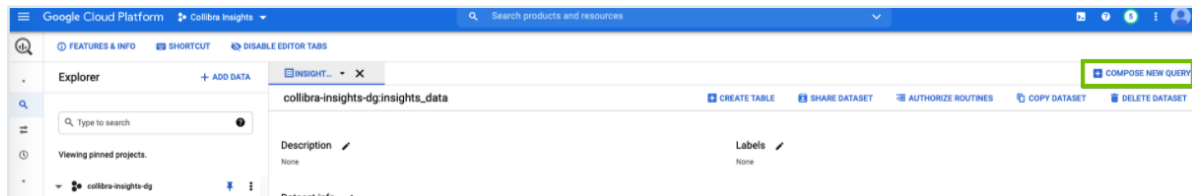

3. From one of the report template packages you downloaded from Collibra Marketplace, drag and drop one of the SQL files into a new query tab.
 - » The code appears in the query tab.
4. In the code, change any occurrences of "<customer_dataset>" to "<the-name-of-your-Insights-dataset>".

Tip The dataset name is the value you entered in the Dataset ID field in step 3 of the [Create the Reporting Data Layer on Google Cloud Platform](#) procedure.

5. Click **Save > Save View**.

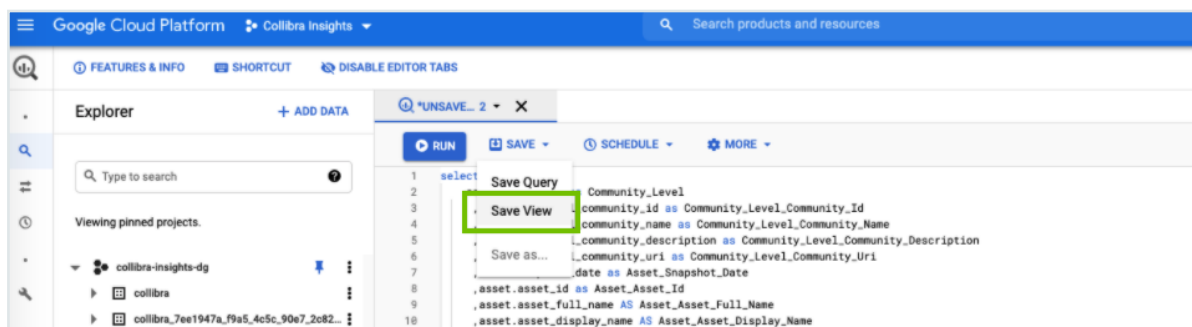

- » The **Save view** dialog box appears.

6. In the **Save view** dialog, enter the relevant information:

Save view

❗ The destination dataset for a saved view must be in the same region as the source, otherwise a "Dataset not found" error will be returned.

Project *
collibra-insights-dg BROWSE

Dataset ID *
insights_data

Table name *
data_maturity

Unicode letters, marks, numbers, connectors, dashes or spaces allowed. The job will create the specified destination table if needed, or the table must be empty if it already exists.

SAVE CANCEL

Field	Description
Project	The project you are using for Insights deployment.
Dataset ID	The value you entered in the Dataset ID field in step 3 of the Create the Reporting Data Layer on Google Cloud Platform procedure .
Table name	The name of the report SQL file, for example "data_maturity".

7. Repeat steps 3-5 for the SQL files in the other two report template packages.

Step 3: Publish the workbook files to your Tableau Server or Online account and configure a refresh schedule event

1. On your hard drive, go to the folder of one of the report templates you downloaded from Collibra Marketplace, for example DataMaturity.
2. Open the Tableau Workbook file, in this example DataMaturityDashboard.twbx.
 - » The Google sign in page appears.

3. Select the relevant Google account.

» You are prompted to allow Tableau to access your Google account.

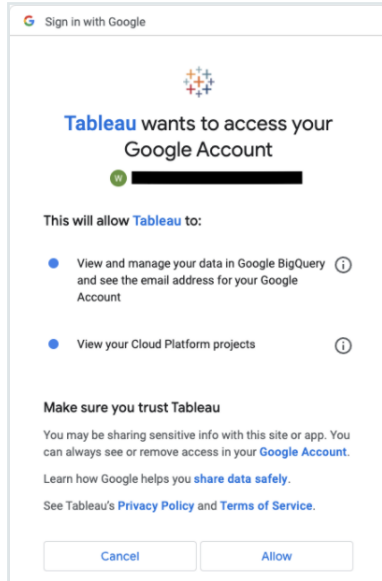

4. Ensure that both access options are selected, and then click **Allow**.

5. In the Tableau DataMaturityDashboard, click **Edit Connection** in the **Dashboard Unavailable** notification.

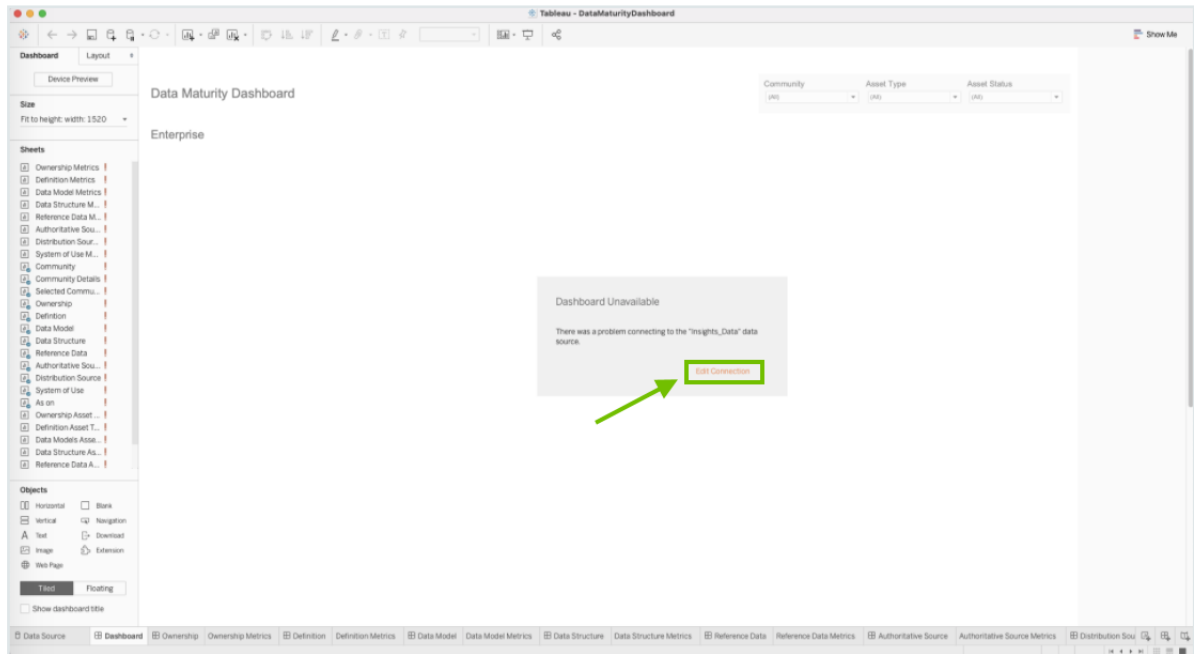

» The **Data Source** tab opens.

6. Specify the following information:

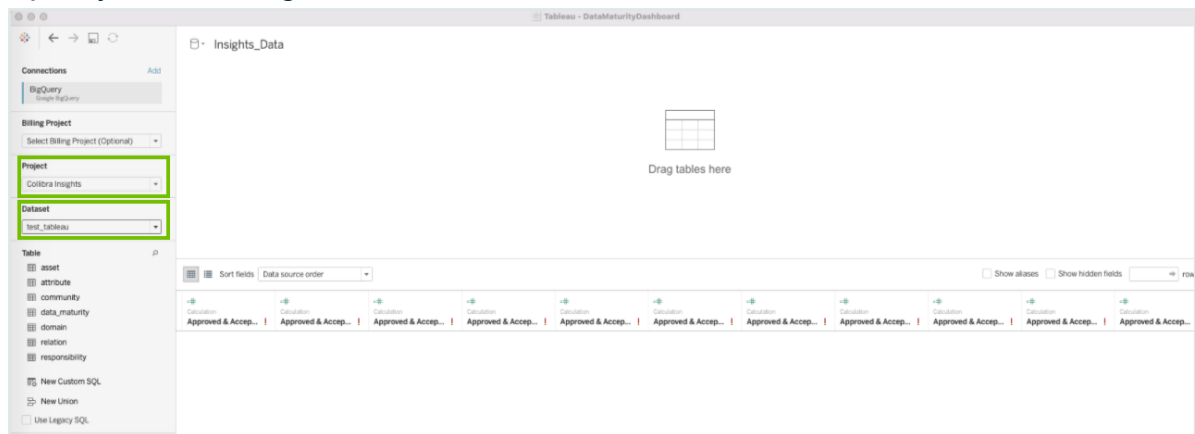

Field	Description
Project	The project you are using for Insights deployment.
Dataset	What should the user choose?

7. In the **Table** section, double-click on the **data_maturity** view.

» The view appears in the main frame, indicating that a link to the data is made.

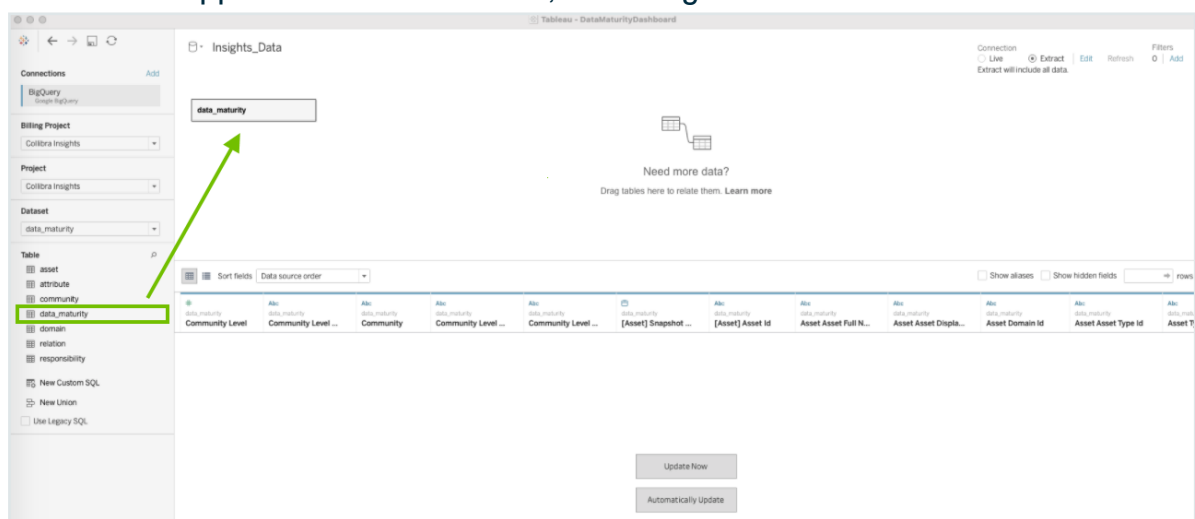

8. In the upper-right corner of the page, select an **Extract** connection.



9. In the lower-left corner of the page, click the **Dashboard** tab.

10. In the **Save As** dialog box, enter a name for the database extract file.

11. Click **Save**.
 - » The extract file is saved and a database extract is cached. This can take several minutes to complete.
12. When the dashboard is loaded, click  or **File > Save**, to save the database extract.
13. In the main menu, click **Server** and then click **Sign In**.

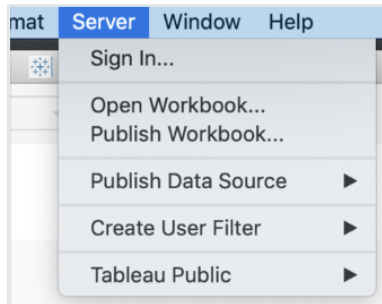

14. In the **Tableau Server Sign in** dialog box, click **Connect**.



15. Enter your Tableau sign in credentials.
16. Select the site to which you want to publish the Tableau workbook.



17. Click **Server** and then select **Publish Workbook**.

» The following dialog box appears.

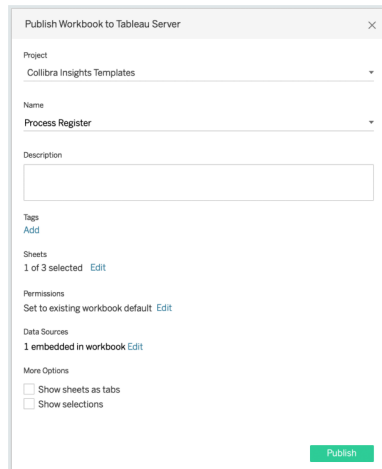

18. Enter the required information.

The following fields are of interest for this task:

Property	Description
Project	The project to which you want to publish.
Name	The name of the workbook.
Refresh Schedule (Full Extract)	<p>The frequency with which the currently cached database extract is purged, and a new extract is cached.</p> <p>Tip We recommend that you schedule a daily refresh.</p>
Sheets	<p>Allows you to specify which sheets to include in the publication. You can hide sheets if you want to publish a dashboard without showing all the worksheets that were used to create it.</p> <p>Tip To avoid clutter, we recommend that you click Edit and then click Only Dashboards.</p>

Property	Description
Data Sources	<p>Determines:</p> <ul style="list-style-type: none"> ◦ Whether the data is embedded in the workbook or published separately. ◦ How users authenticate with data sources. <p>Tip We strongly recommend the following settings. Click Edit and then:</p> <ul style="list-style-type: none"> ◦ In the Publish Type drop-down menu, select Embedded in workbook. This enables users to view the report without having to authenticate themselves every time. ◦ In the Authentication drop-down menu, select Allow refresh access. This automatically refreshes the extract of the database. The frequency with which the cache is refreshed is determined by the value you enter in the Refresh Schedule field.
More options	<p>Additional publication options. The "Include external files" determines whether or not external files are included in the publication.</p> <p>Note Only the DataMaturityDashboard.twbx file refers to external files. The Include external files option will not be available for the other Tableau workbook files.</p> <p>Tip Ensure that the Include external files is selected, so that the images we've included with the Tableau workbook files are included in the publication.</p>

19. Click **Publish**.

- » The report is published to your Tableau Server or Online account.

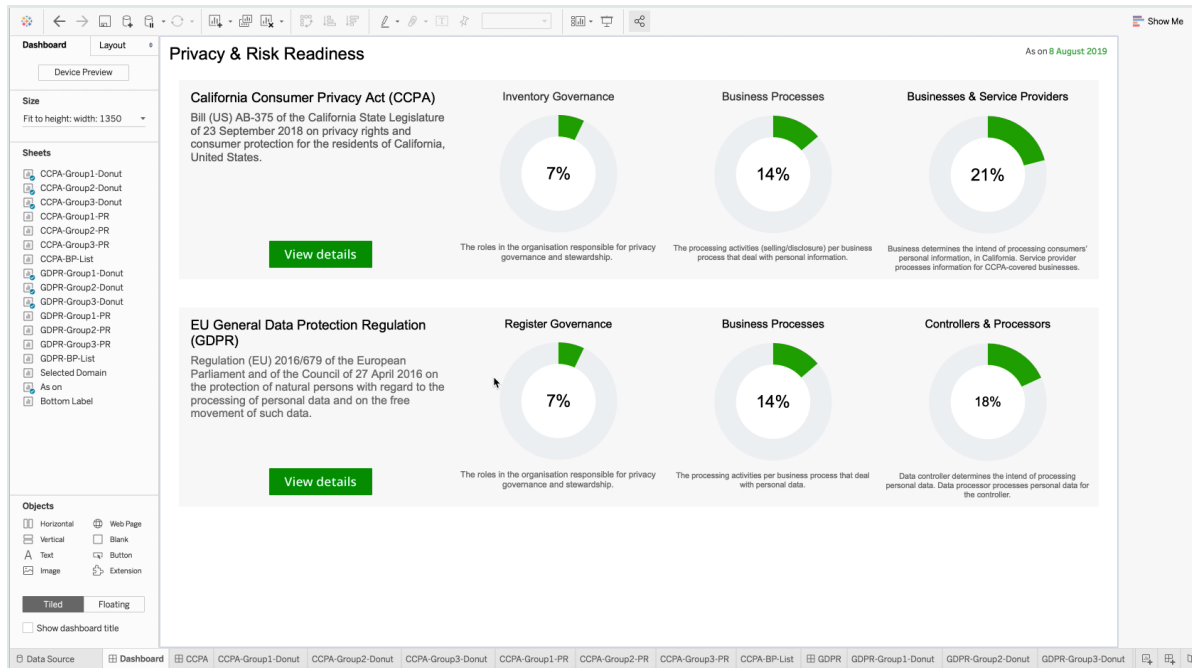

Tip In the Refresh Schedules tab, you can see the refresh schedule event you configured.

Home / Collibra Insights Templates / Data Maturity Dashboard

Data Maturity Dashboard
 WORKBOOK • By Admin • 305 views • ☆ 0 • Extract: 30 Jul 2019, 16:55

Views 9 | Data sources 1 | **Refresh Schedules 1** | Subscriptions 0 | Details

+ New Extract Refresh | 0 items selected

Refresh type	Schedule	Priority	Last update	Next update
<input type="checkbox"/> Full refresh	Weekday early mornings – Weekly at 06:00 on Monday, Tuesday, Wednesday, Thursday, and Friday	50	Never	27 Aug 2019, 06:00

Step 4: Configure the reporting options in Collibra DGC Settings

1. On the **Workbooks** tab in Tableau, click one of the workbook files, for example **Privacy & Risk Readiness**.

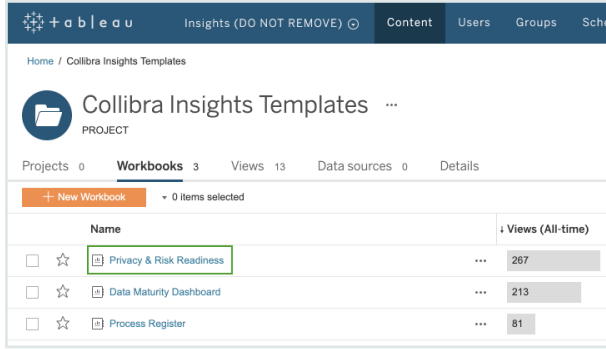

2. Click Dashboard.

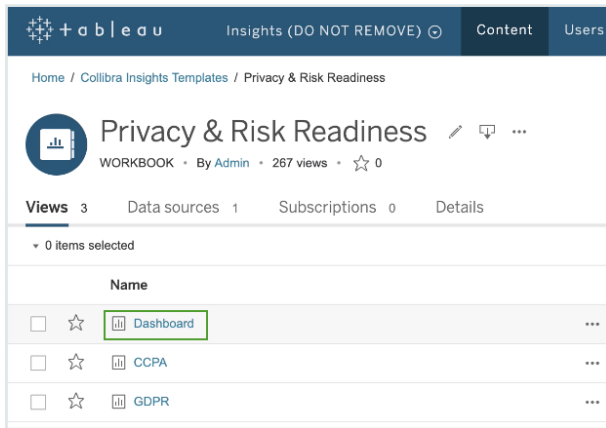

3. Click Share.

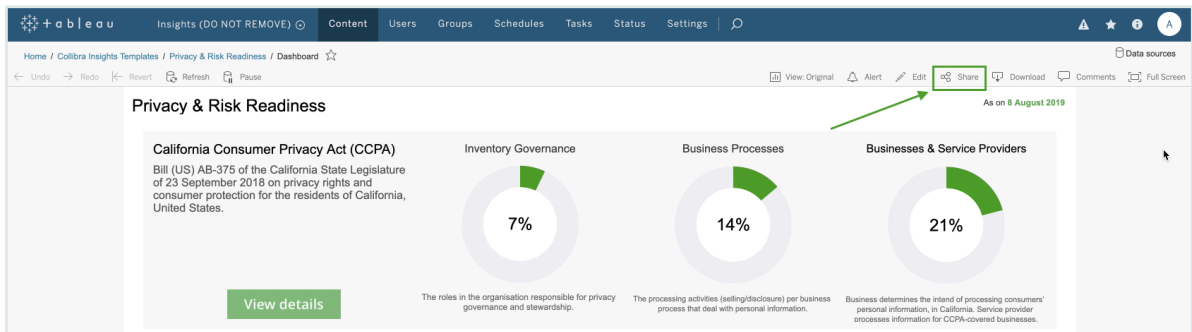

4. In the **Share** dialog box, copy the URL in the **Link** field.

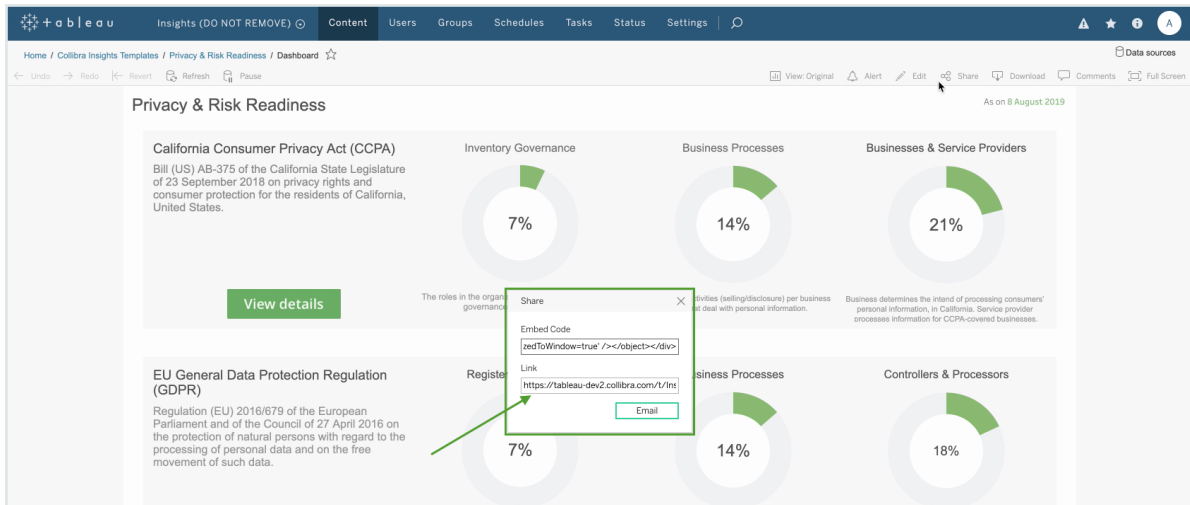

5. Open Collibra Console with a user profile that has at least the **ADMIN** role.
 - » Collibra Console opens with the **Infrastructure** page.
6. In the tab pane, click the Data Governance Center service of a Collibra DGC environment.
 - » The details of the DGC service are shown.
7. Click **Configuration**.
8. Click **Edit configuration**.
9. Scroll down the list of configuration options and click **Reporting**.

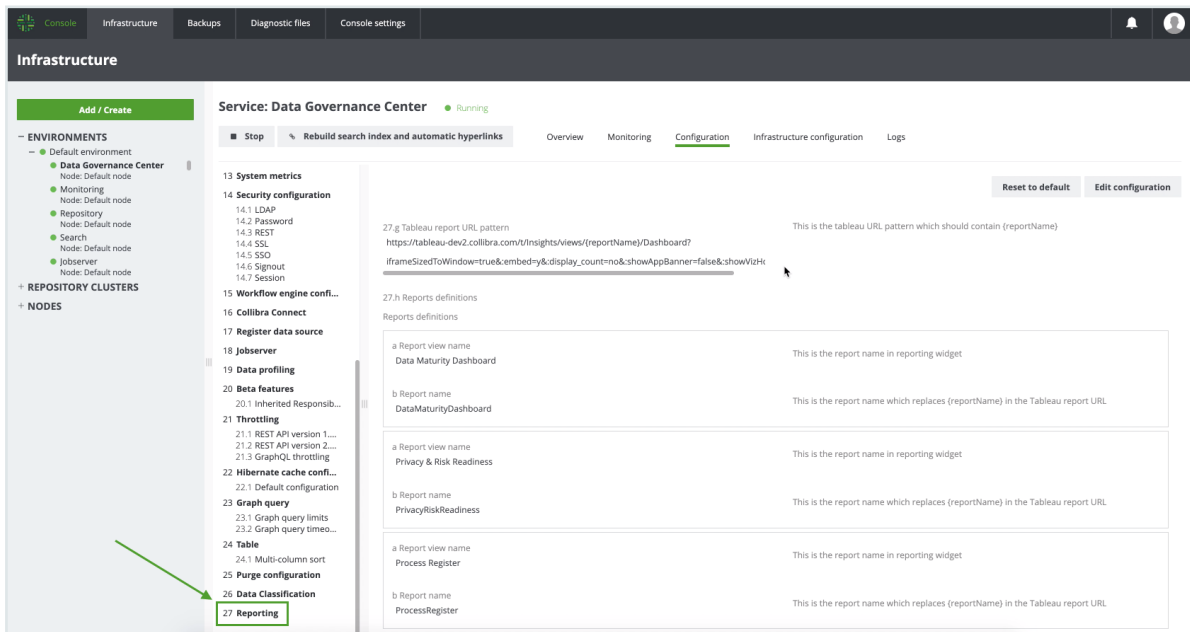

10. In field **Tableau report URL pattern**, paste the URL that you copied from the **Link** field in Tableau.

27.g Tableau report URL pattern	This is the tableau URL pattern which should contain {reportName}
<pre>https://tableau-dev2.collibra.com/t/Insights/views/{reportName}/Dashboard? iframeSizedToWindow=true&embed=y&:display_count=no&showAppBanner=false&showVizH</pre>	

11. In the URL, replace the actual report name (such as *DataMaturityDashboard*) by *{reportName}*, for example:
https://tableau-dev2.<your-Collibra-Data-Intelligence-Cloud-environment-URL>/t/Insights/views/{reportName}/iframeSizedToWindow=true&...
12. Under **Reports definitions**, click **Add**.

Note You have to carry out this step for all three reports.

- In field **a Report view name**, enter the name of a report, as you want it to appear on the report button in the Collibra Insights widget, for example:

- Data Maturity Dashboard
- Privacy & Risk Readiness
- Process Register

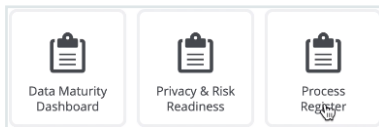

- In field **b Report name**, enter the report name, for example:

- DataMaturityDashboard
- PrivacyRiskReadiness
- ProcessRegister

Tip Use the name as it appears in the URL of the Tableau report, for example "DataMaturityDashboard".

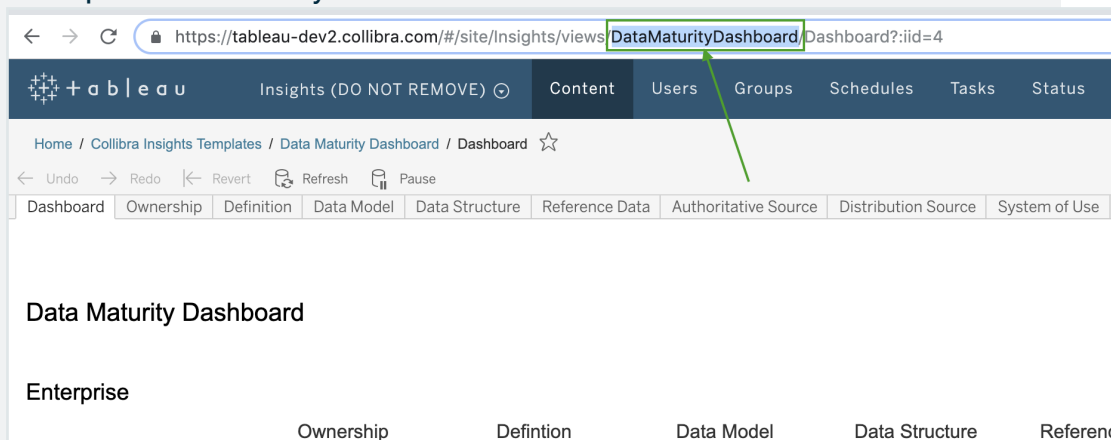

The settings in Console should look similar to the following example image:

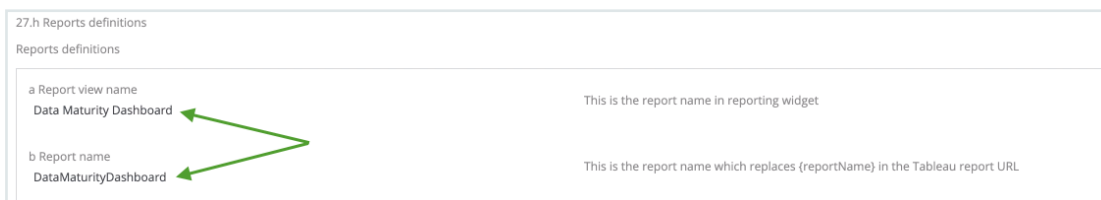

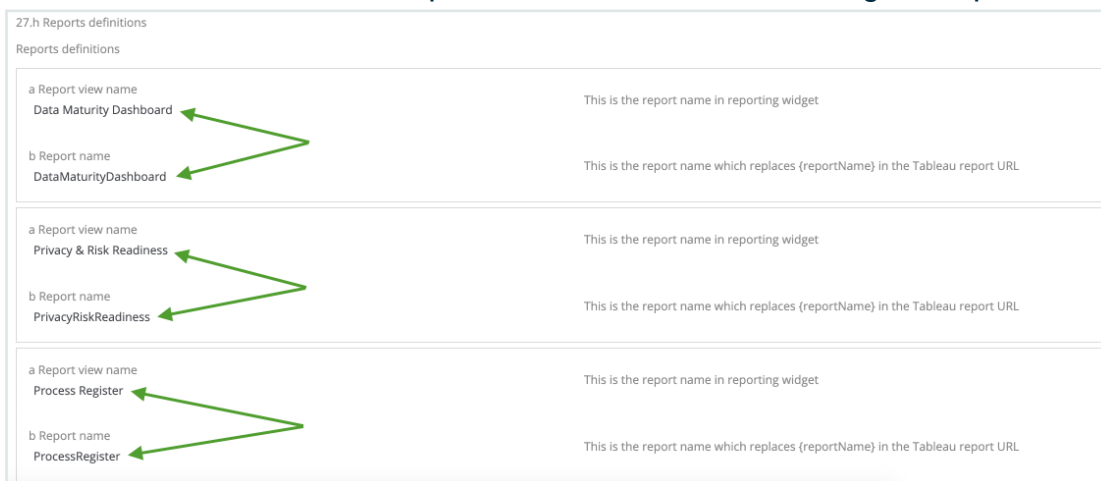

- Click **Add**, and then add the report definitions for the remaining two reports.



13. Click **Save all**.

Step 5: Add a dashboard in Collibra DGC and configure the Collibra Insights widget

Tip To facilitate the viewing of each report, we recommend that you add and configure a separate dashboard for each report. To do so, you have to complete this step for each report.

1. In the Collibra DGC main menu, click  → **Dashboards**.
2. In the view bar, click  → **Add Dashboard**.
3. Enter the required information.

Property	Description
Name	The name of your new dashboard.
Description	A description of the dashboard (optional).
Layout	The number of columns in the layout of the dashboard. Tip Ensure that 1 column is selected.
Always visible in the toolbar.	Option to always show the dashboard in the toolbar.

4. Click **Save**.
5. In the view bar, click  → **Edit widgets**.
6. Find the Collibra Insights widget and drag it onto the dashboard.

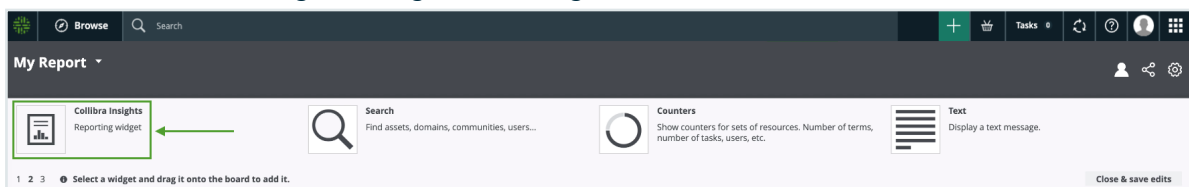

» The three reports that you configured in Collibra DGC Settings are shown:

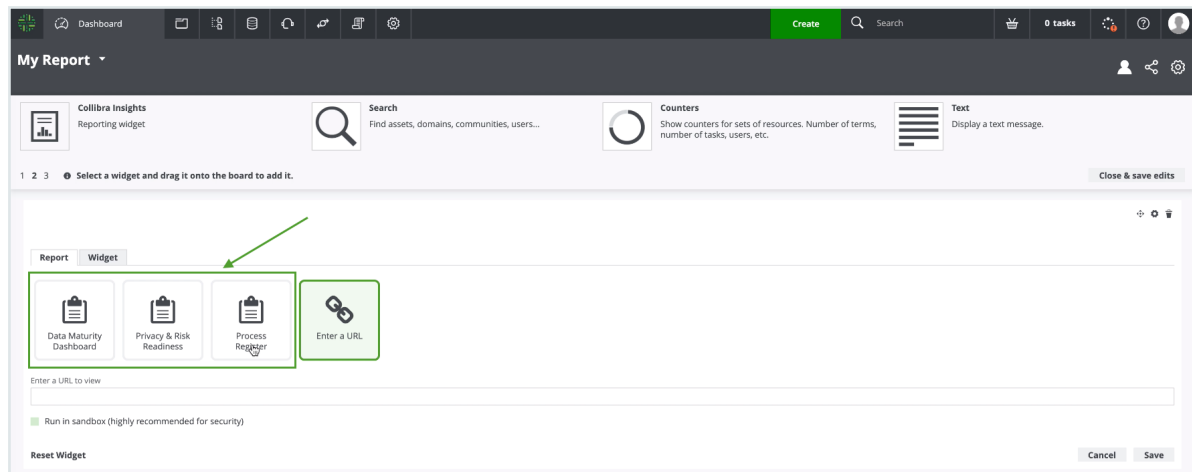

7. Select the report you want to show on the dashboard.
8. Click **Save**.
 - » The report is shown on the dashboard you created.

What's next?

Optionally, you can:

- **Remove** non-applicable regulation placeholder.
- **Improve** the visual output of the Data Maturity report.

Generate a dashboard report via URL on GCP

After creating the [Reporting Data Layer](#) on Google Cloud Platform, you can generate a dashboard report via a URL, from tools such as Tableau Online, Power BI, Qlik, or ThoughtSpot.

Prerequisites

You have:

- The Insights global role, to be able to view a report in Collibra Data Governance Center.
- **Created** the Reporting Data Layer on GCP.
- A license for Tableau Desktop 2018.3.
- A Tableau Server or Tableau Online account.

Steps

1. Download the report templates from [Collibra Marketplace](#)
2. Install the SQL views associated with the Tableau workbook files
3. Publish the workbook files to your Tableau Server or Tableau Online account and configure a database extract refresh schedule event
4. Obtain the shareable link
5. Add a dashboard in Collibra DGC and add your report via URL

Step 1: Download the report templates from Collibra Marketplace

1. Go to [Collibra Marketplace](#).
2. Download the following three report template packages:
 - Process Register Report Template
 - Privacy and Risk Readiness Report Template
 - Data Maturity Report Template
 - » The three ZIP files are downloaded to your hard disk.
3. Extract the ZIP files on your local computer.
 - » Folders with the names of the ZIP files are created. Each folder contains a SQL file and a TWBX file.

Step 2: Install the SQL views associated with the Tableau workbook files

Note

- If this is the first time you are installing the SQL views, you have to carry out this step for each of the Tableau workbook files.
- If you have previously installed the SQL views, but are now installing a new version of a report, you have to install the new SQL view, if one was provided with the new report.

1. In the **BIG DATA** section of the GCP left-hand menu, click **BigQuery**.
2. In the **Explorer** page, click **COMPOSE NEW QUERY**.

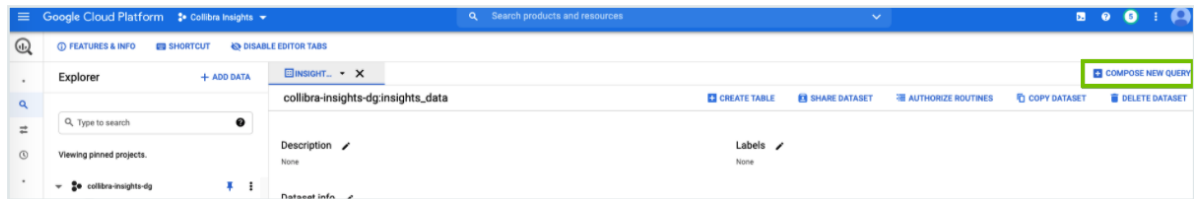

3. From one of the report template packages you downloaded from Collibra Marketplace, drag and drop one of the SQL files into a new query tab.
 - » The code appears in the query tab.
4. In the code, change any occurrences of "<customer_dataset>" to "<the-name-of-your-Insights-dataset>".

Tip The dataset name is the value you entered in the Dataset ID field in step 3 of the [Create the Reporting Data Layer on Google Cloud Platform](#) procedure.

5. Click **Save > Save View**.

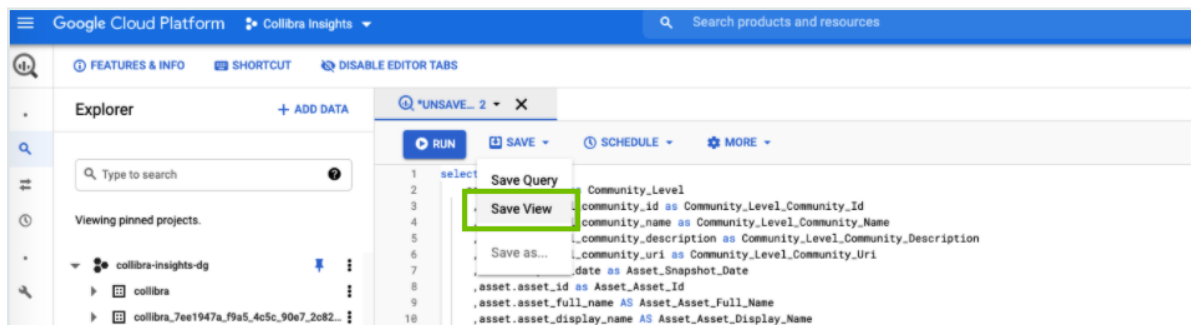

» The **Save view** dialog box appears.

6. In the **Save view** dialog, enter the relevant information:

Save view

The destination dataset for a saved view must be in the same region as the source, otherwise a "Dataset not found" error will be returned.

Project *
collibra-insights-dg BROWSE

Dataset ID *
insights_data

Table name *
data_maturity

Unicode letters, marks, numbers, connectors, dashes or spaces allowed. The job will create the specified destination table if needed, or the table must be empty if it already exists.

SAVE **CANCEL**

Field	Description
Project	The project you are using for Insights deployment.
Dataset ID	The value you entered in the Dataset ID field in step 3 of the Create the Reporting Data Layer on Google Cloud Platform procedure.
Table name	The name of the report SQL file, for example "data_maturity".

- Repeat steps 3-5 for the SQL files in the other two report template packages.

Step 3: Publish the workbook files to your Tableau Server or Online account and configure a refresh schedule event

- On your hard drive, go to the folder of one of the report templates you downloaded from Collibra Marketplace, for example DataMaturity.
- Open the Tableau Workbook file, in this example DataMaturityDashboard.twbx.
 - » The Google sign in page appears.
- Select the relevant Google account.
 - » You are prompted to allow Tableau to access your Google account.

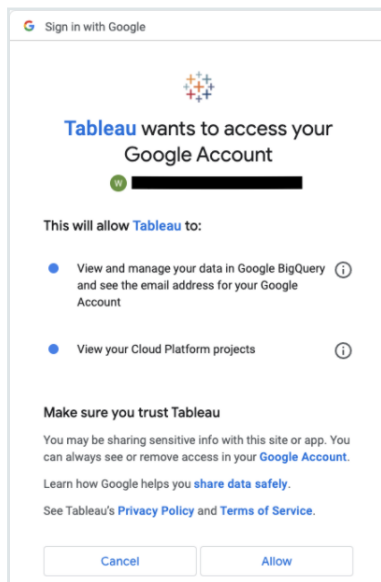

- Ensure that both access options are selected, and then click **Allow**.

- In the Tableau DataMaturityDashboard, click **Edit Connection** in the **Dashboard Unavailable** notification.

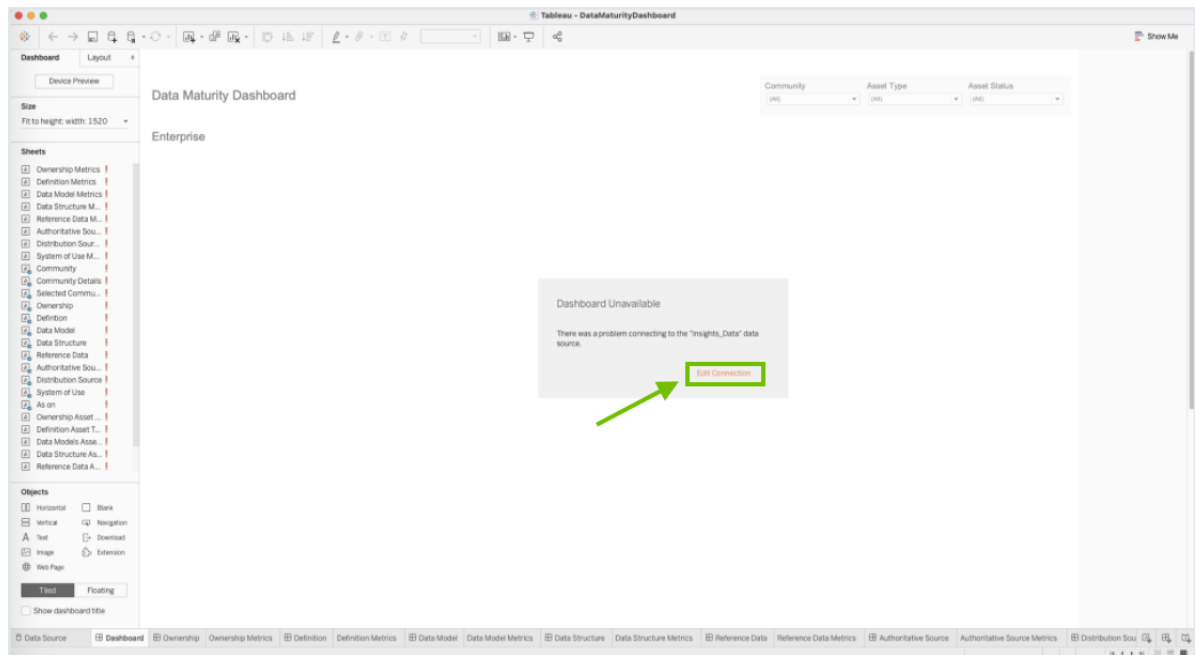

» The **Data Source** tab opens.

- Specify the following information:

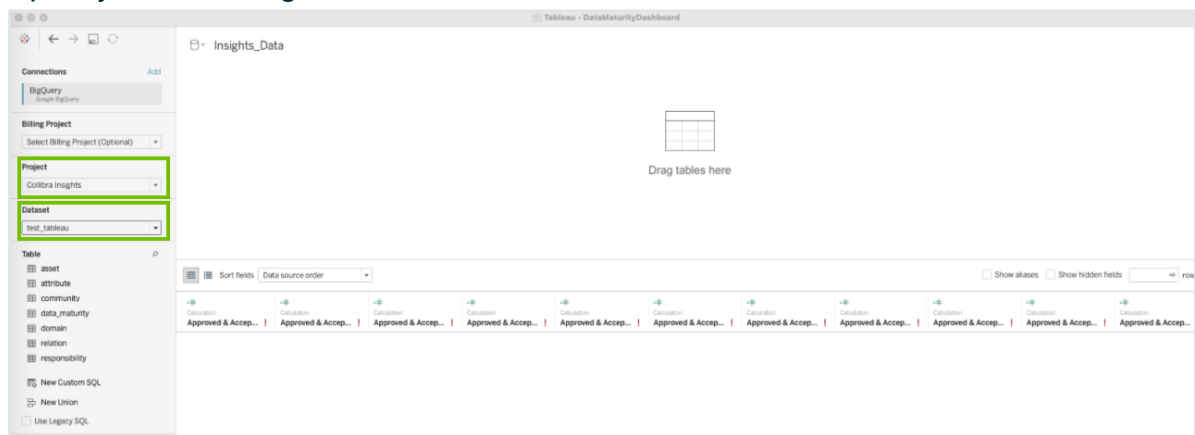

Field	Description
Project	The project you are using for Insights deployment.
Dataset	What should the user choose?

7. In the **Table** section, double-click on the **data_maturity** view.
 - » The view appears in the main frame, indicating that a link to the data is made.

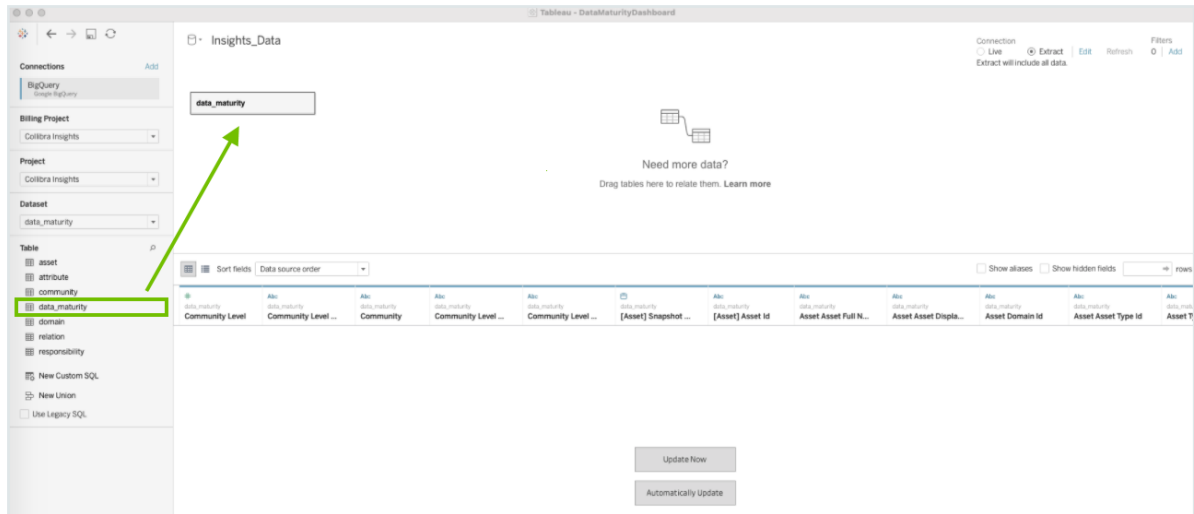

8. In the upper-right corner of the page, select an **Extract** connection.



9. In the lower-left corner of the page, click the **Dashboard** tab.
10. In the **Save As** dialog box, enter a name for the database extract file.
11. Click **Save**.
 - » The extract file is saved and a database extract is cached. This can take several minutes to complete.
12. When the dashboard is loaded, click  or **File > Save**, to save the database extract.
13. In the main menu, click **Server** and then click **Sign In**.

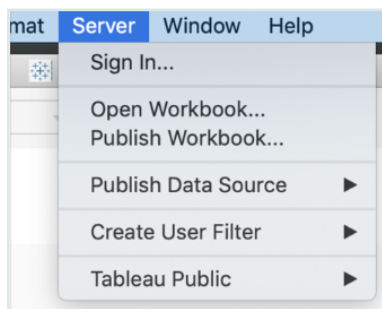

14. In the **Tableau Server Sign in** dialog box, click **Connect**.

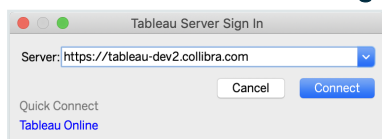

15. Enter your Tableau sign in credentials.

16. Select the site to which you want to publish the Tableau workbook.



17. Click **Server** and then select **Publish Workbook**.
 » The following dialog box appears.

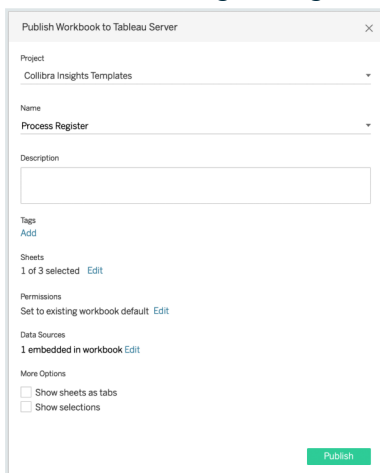

18. Enter the required information.
 The following fields are of interest for this task:

Property	Description
Project	The project to which you want to publish.
Name	The name of the workbook.
Refresh Schedule (Full Extract)	The frequency with which the currently cached database extract is purged, and a new extract is cached. <div style="border: 1px solid #ccc; padding: 5px; margin-top: 10px;"> <p>Tip We recommend that you schedule a daily refresh.</p> </div>

Property	Description
Sheets	<p>Allows you to specify which sheets to include in the publication. You can hide sheets if you want to publish a dashboard without showing all the worksheets that were used to create it.</p> <p>Tip To avoid clutter, we recommend that you click Edit and then click Only Dashboards.</p>
Data Sources	<p>Determines:</p> <ul style="list-style-type: none"> ◦ Whether the data is embedded in the workbook or published separately. ◦ How users authenticate with data sources. <p>Tip We strongly recommend the following settings. Click Edit and then:</p> <ul style="list-style-type: none"> ◦ In the Publish Type drop-down menu, select Embedded in workbook. This enables users to view the report without having to authenticate themselves every time. ◦ In the Authentication drop-down menu, select Allow refresh access. This automatically refreshes the extract of the database. The frequency with which the cache is refreshed is determined by the value you enter in the Refresh Schedule field.

Property	Description
More options	<p>Additional publication options. The "Include external files" determines whether or not external files are included in the publication.</p> <p>Note Only the DataMaturityDashboard.twbx file refers to external files. The Include external files option will not be available for the other Tableau workbook files.</p> <p>Tip Ensure that the Include external files is selected, so that the images we've included with the Tableau workbook files are included in the publication.</p>

19. Click **Publish**.

» The report is published to your Tableau Server or Online account.

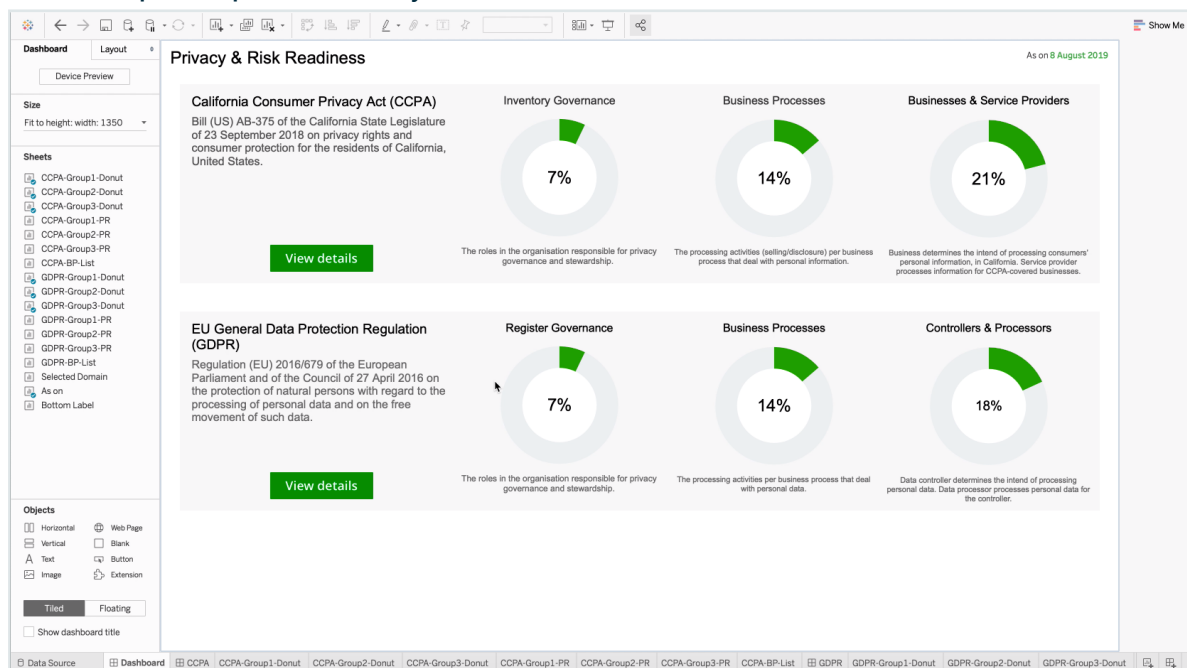

Tip In the Refresh Schedules tab, you can see the refresh schedule event you configured.

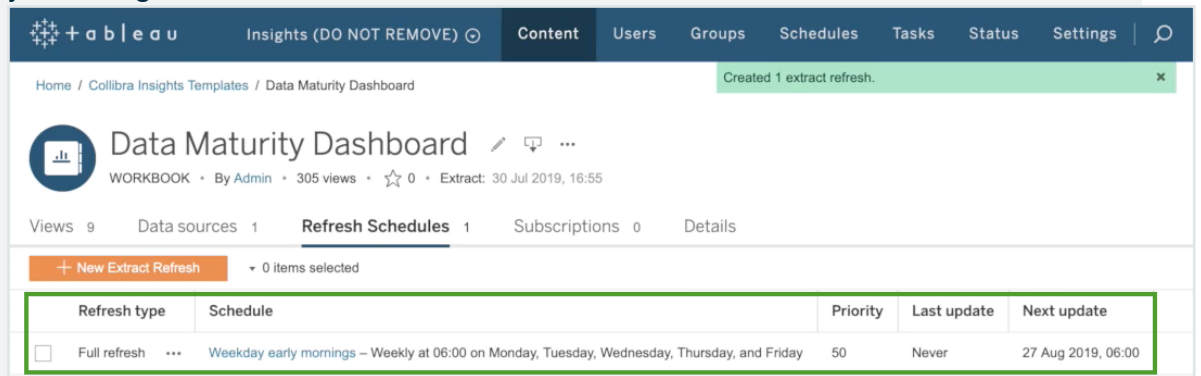

Step 4: Obtain the shareable link

1. On the **Workbooks** tab in Tableau, click one of the workbook files, for example **Privacy & Risk Readiness**.

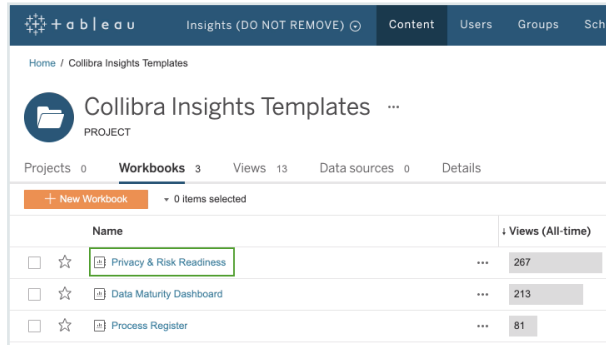

2. Click **Dashboard**.

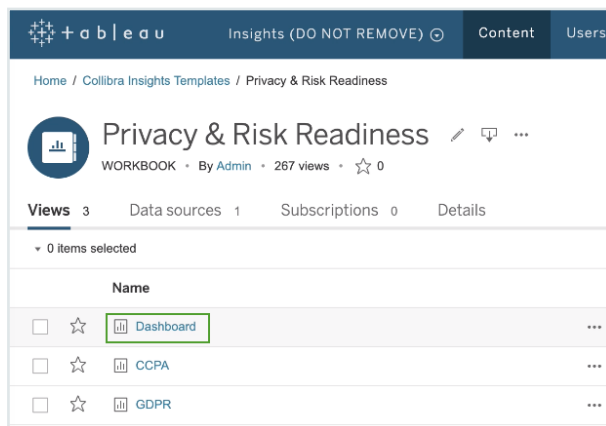

3. Click Share.

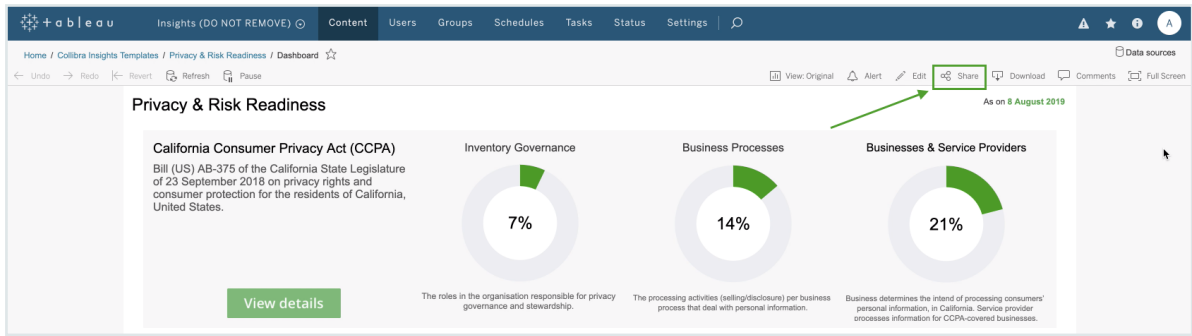

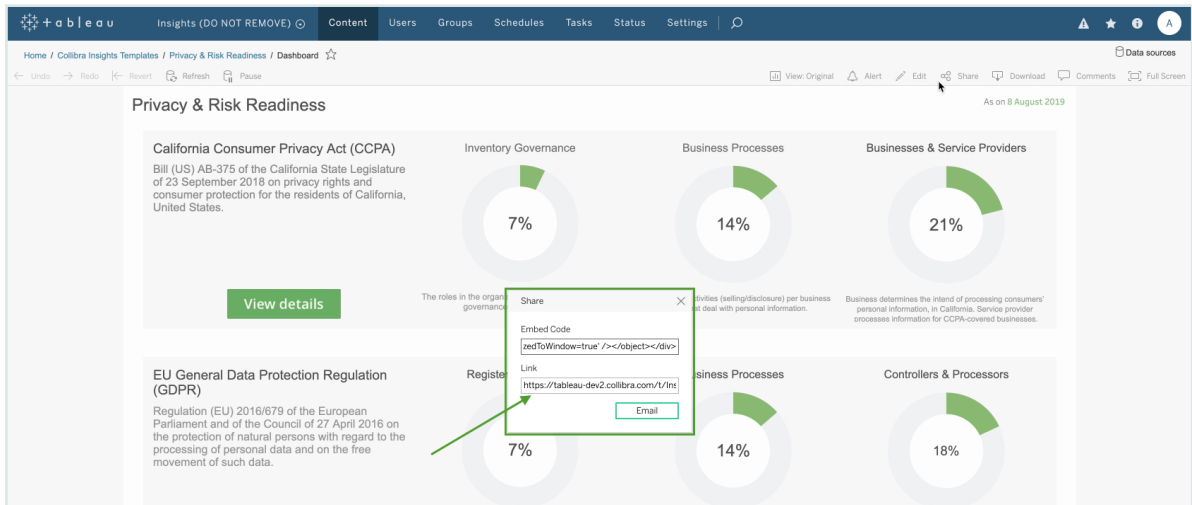

4. In the Share dialog box, copy the URL in the Link field.



Step 5: Add a dashboard in Collibra DGC and then add your report via URL

Tip To facilitate the viewing of each report, we recommend that you add and configure a separate dashboard for each report. To do so, you have to complete this step for each report.

1. In the Collibra DGC main menu, click  → **Dashboards**.
2. In the view bar, click  → **Add Dashboard**.

3. Enter the required information.

Property	Description
Name	The name of your new dashboard.
Description	A description of the dashboard (optional).
Layout	The number of columns in the layout of the dashboard. <div style="border: 1px solid #ccc; background-color: #f9f9f9; padding: 10px; margin: 10px 0;"> <p>Tip Ensure that 1 column is selected.</p> </div>
Always visible in the toolbar.	Option to always show the dashboard in the toolbar.

4. Click **Save**.
5. In the view bar, click  → **Edit widgets**.
6. Find the Collibra Insights widget and drag it onto the dashboard.

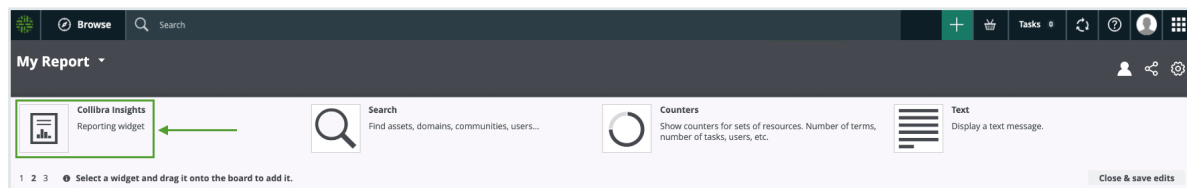

7. Click Enter a URL, and enter the relevant URL.

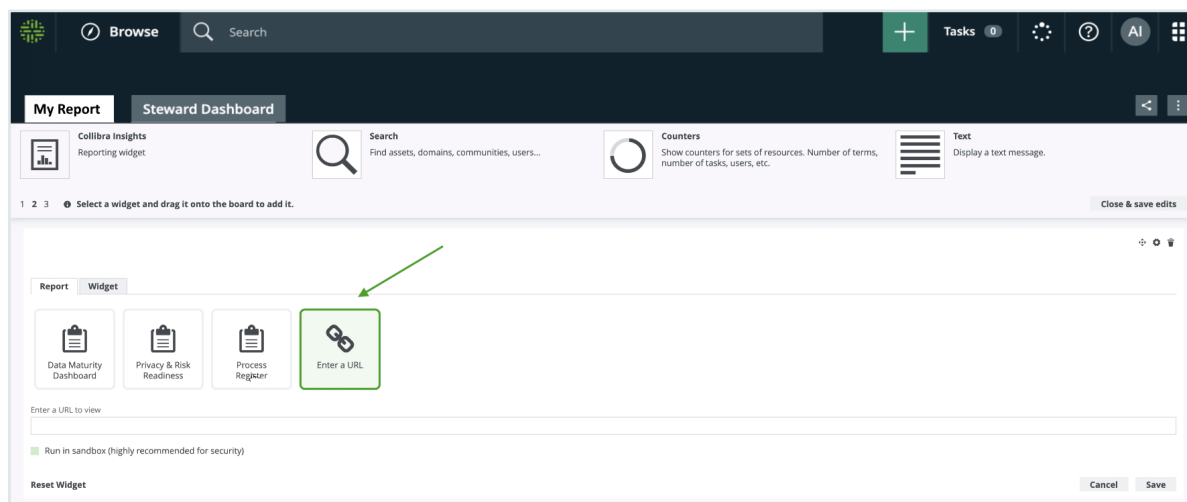

8. Click **Save**.
 - » The report is shown on the dashboard you created.

What's next?

Optionally, you can:

- **Remove** non-applicable regulation placeholder.
- **Improve** the visual output of the Data Maturity report.

Improving the visual output of the Data Maturity report

A well configured Data Maturity report will look something like the following image.

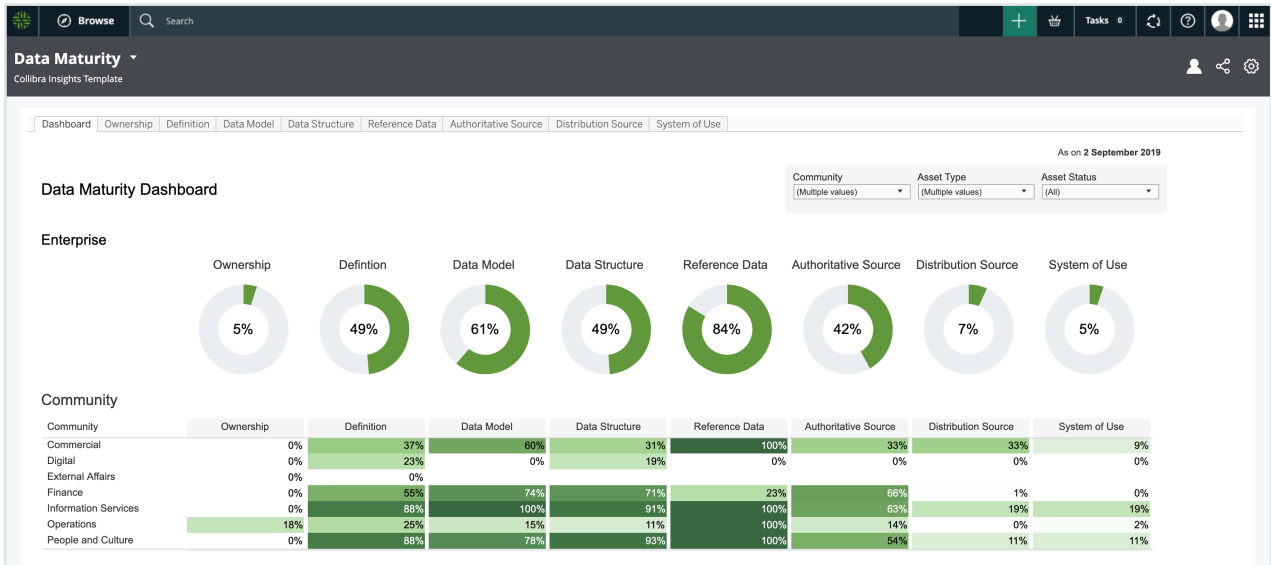

However, it's possible that you correctly configured the Data Maturity report, but it looks more like the following image.

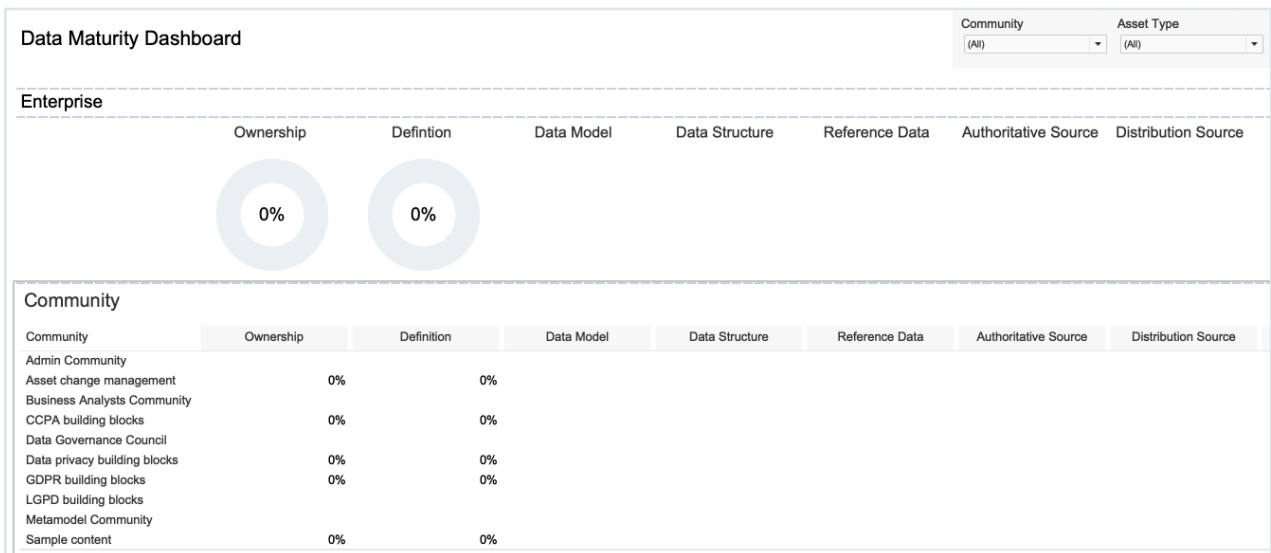

Common scenarios and tips

Here are some common scenarios, explanations and tips for improving the visual output of the report.

The progress circle charts show 0%

In the following example image, the Ownership progress circle chart shows 0%.

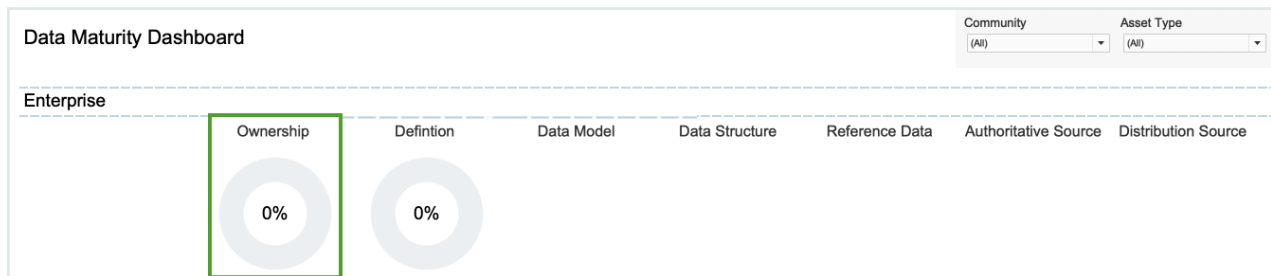

If you go to the **Ownership Metrics** tab, you see that there are many Business Term assets for inclusion in the report. One might expect that the presence of these assets would be reflected in the circle chart. However, the formula for calculating the percentage entails a division operation involving the number of assets with the status Approved. In this example, there are no assets that have the status Approved, and this "0" value results in an Ownership percentage of 0%.

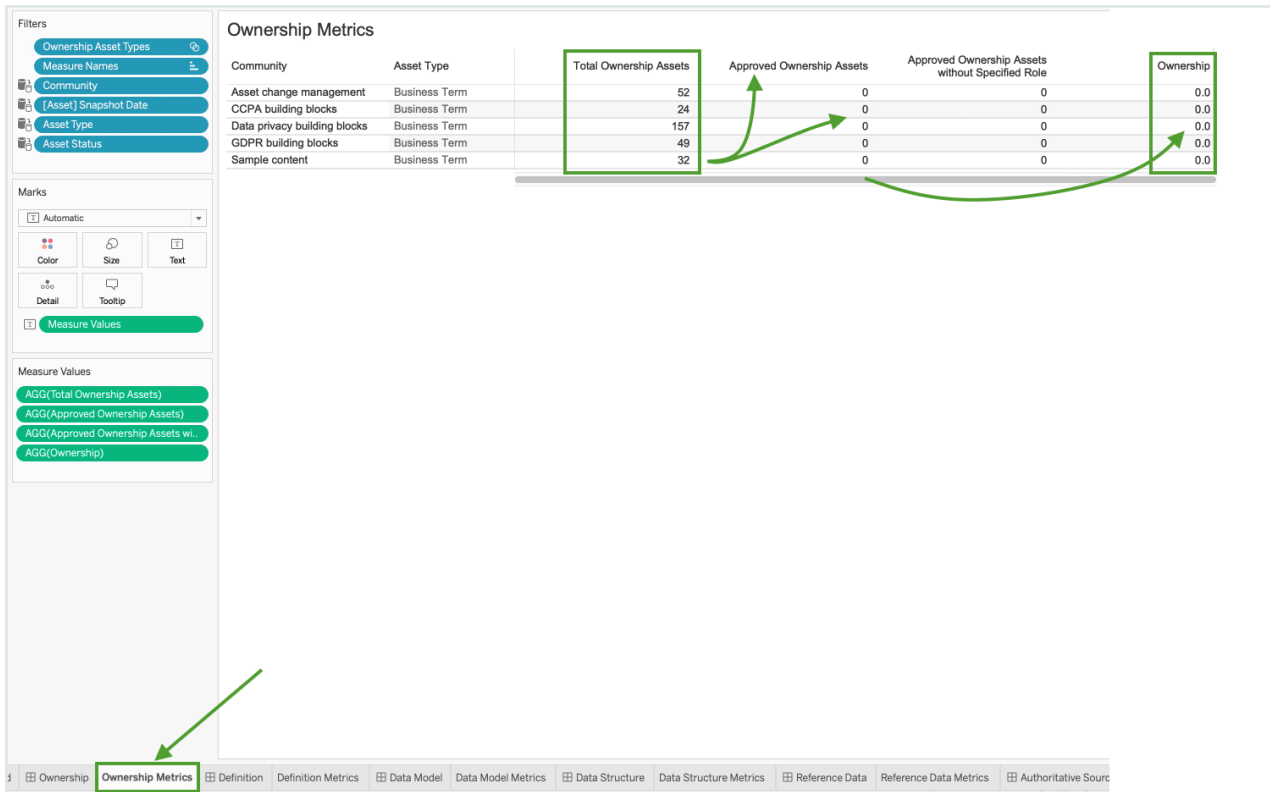

Tip Keep in mind that progress circle charts are reliant on approved assets. In other words, the more mature the data set, the more meaningful the progress circle chart will be.

No progress circle chart is shown

In the following example image, no progress circle chart is shown for the Data Model metric.

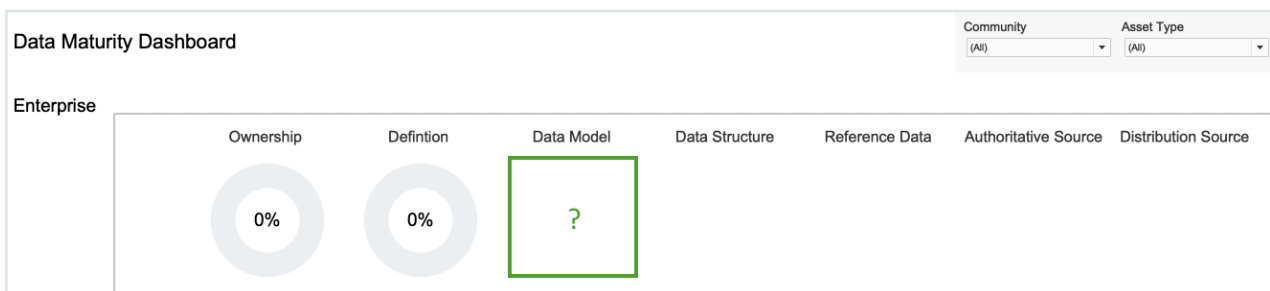

Tip Ensure that the relevant asset types are selected for the Data Model metric.

1. At the bottom of the page, click the **Data Model Metrics** tab.

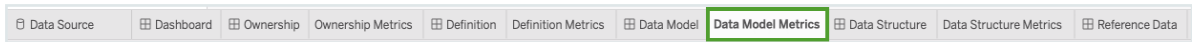

2. In the **Data** tab, select **Data Models Asset Types**, and then select **Edit Set**.

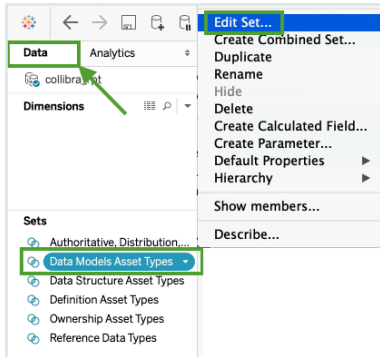

» The Edit Set dialog box appears; however, no asset types are selected.

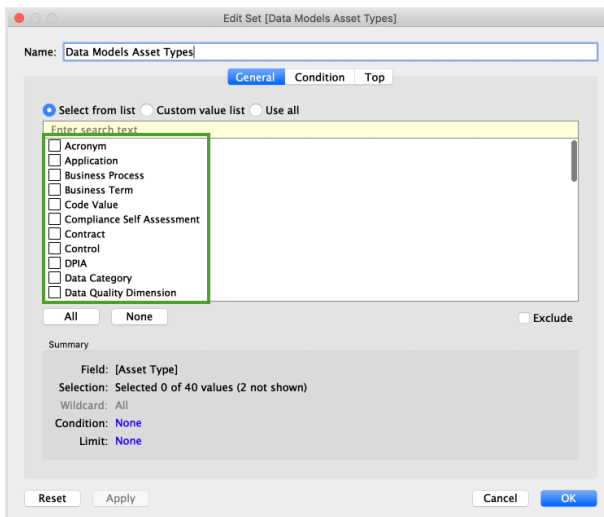

3. Select the asset types that you want to monitor, for example Data Model, Data Entity and Data Attribute.
4. Click **OK**.

» The data is now shown, in accordance with the selected asset types.

Data Model Metrics					
Community	Asset Type	Total Data Model Assets	Approved Data Model Assets	Data Model	
Asset change management	Business Term	52	0	0.0	
	Code Value	52	0	0.0	
CCPA building blocks	Business Term	24	0	0.0	
Data Governance Council	Business Process	2	0	0.0	
Data privacy building blocks	Business Process	82	28	0.3	
	Business Term	157	0	0.0	
	Code Value	52	0	0.0	
GDPR building blocks	Business Term	49	0	0.0	
Sample content	Business Process	82	28	0.3	
	Business Term	32	0	0.0	

Note Keep in mind that the formula for calculating the percentage entails a division operation involving the number of assets with the status Approved.

- On the **Dashboard** tab, the progress circle chart is now shown for the Data Model metric.

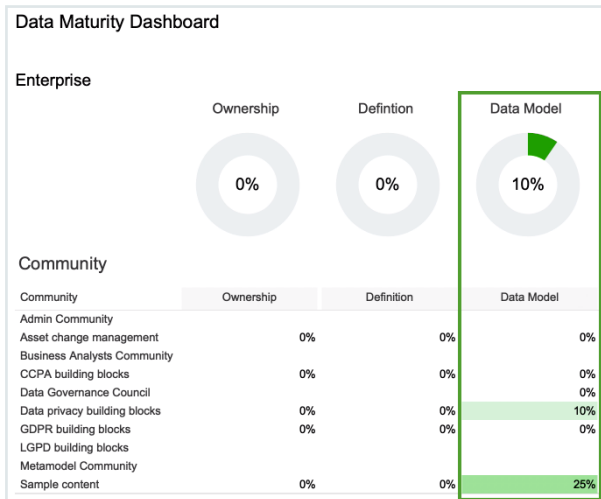

The report includes non-applicable metrics

In this example image, we are not interested in the Data Structure, Reference Data, Authoritative Source and Distribution Source metrics, and want to remove them from the report.

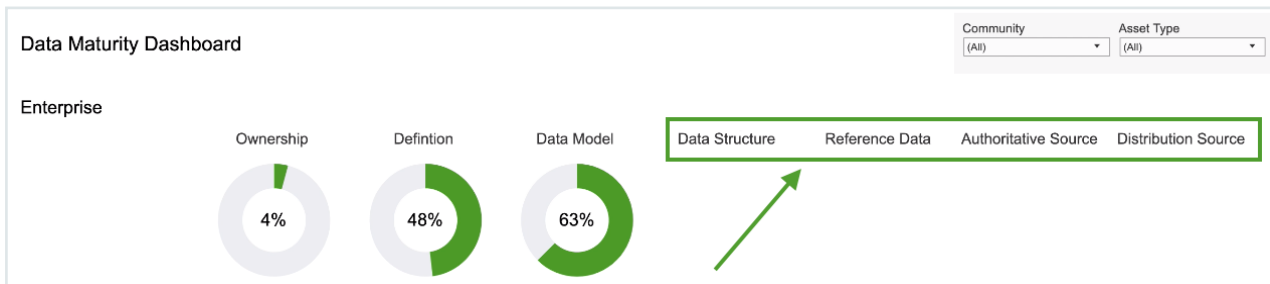

Remove a single metric

- Select a single metric.
You might have to first select the section, for example **Enterprise**, and drag the frame so that you can click an individual metric.

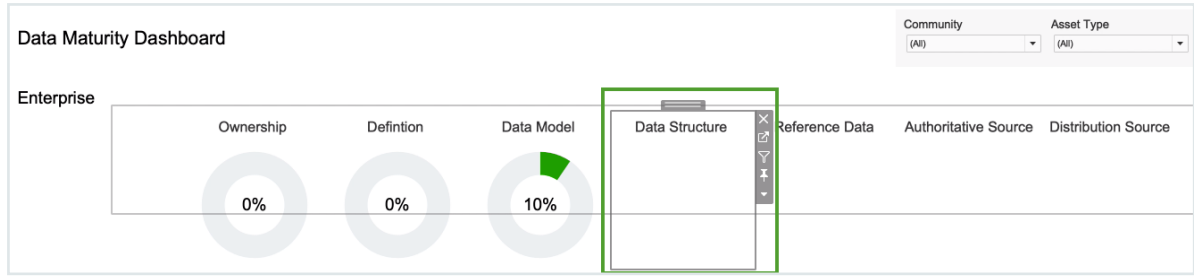

2. Click the Remove from dashboard icon .

Remove several metrics at once

1. Click in the **Community** section, so that the entire section is highlighted.

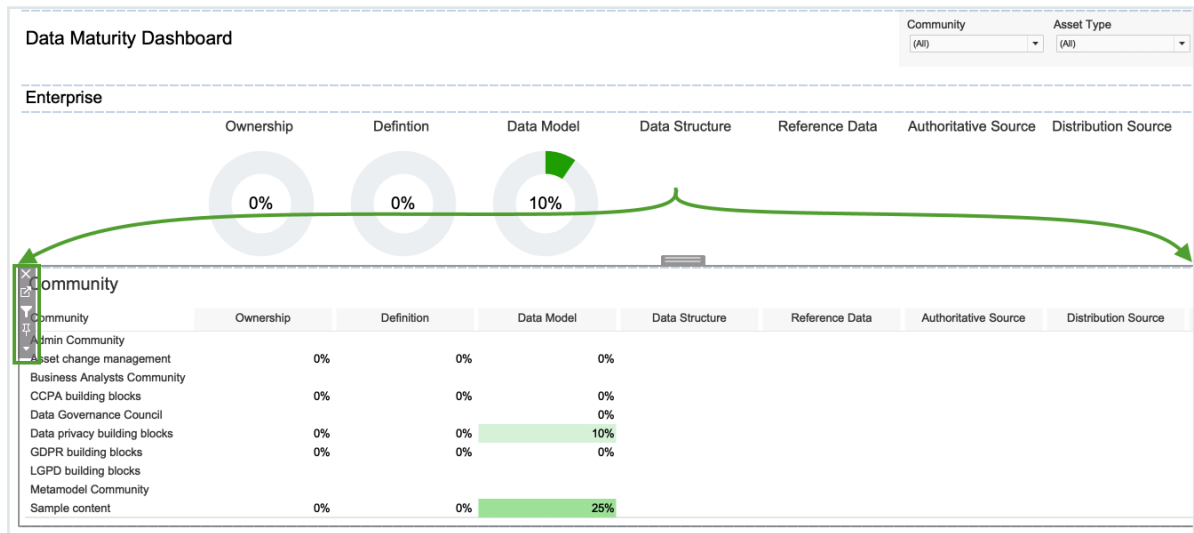

2. Click the "go to sheet" icon .
- » The Community data sheet opens.

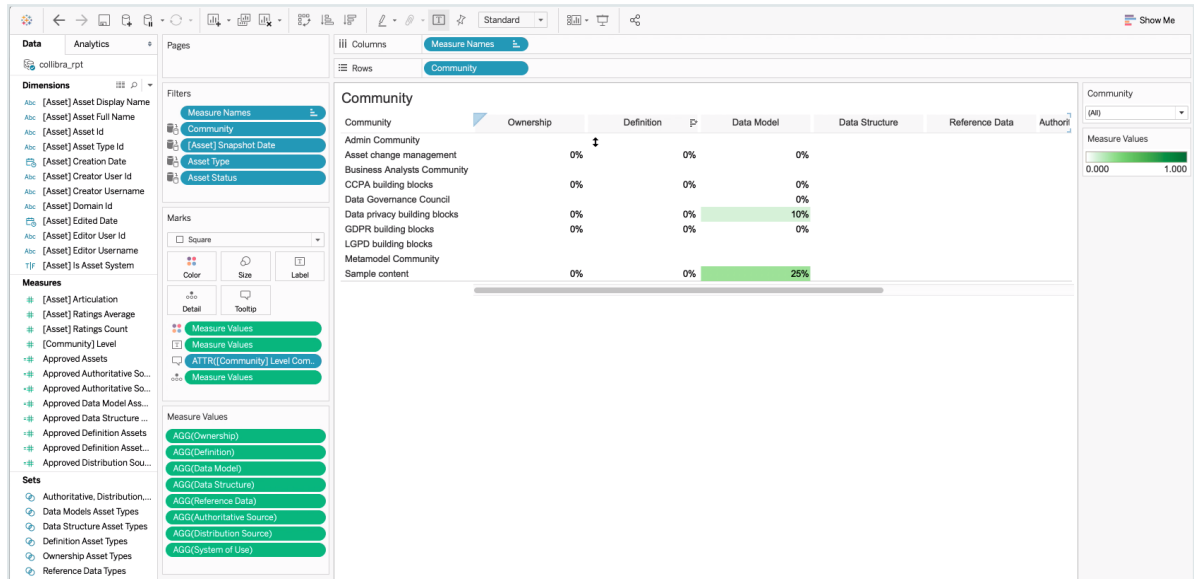

3. In the **Measure Values** section, select the metrics that you want to remove. In this example, we selected Data Structure, Reference Data, Authoritative Source and Distribution Source.

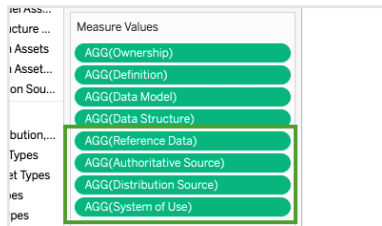

4. Right-click on the selected metrics and select **Remove**.
 - » The metrics at the Community level are deleted.

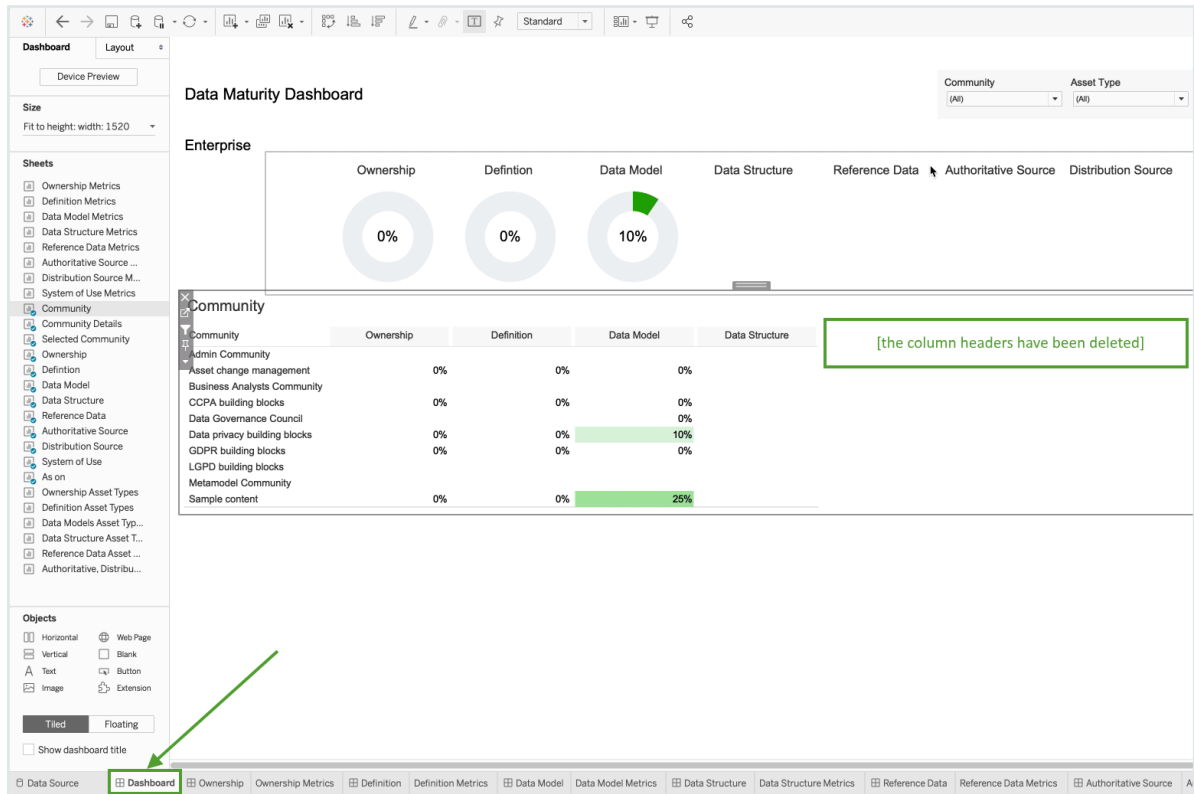



Assets you expected to see in the report are not shown

If assets that you expected to see in the report are not shown, it could be that the status of the assets are not correctly reflected in the relevant measures. By default, the reports are configured to show only assets with the status Approved. Assets with other statuses will not be shown in the reports.

The report templates, however, are fully configurable. You can edit the relevant measures, to include other statuses, such as Accepted.

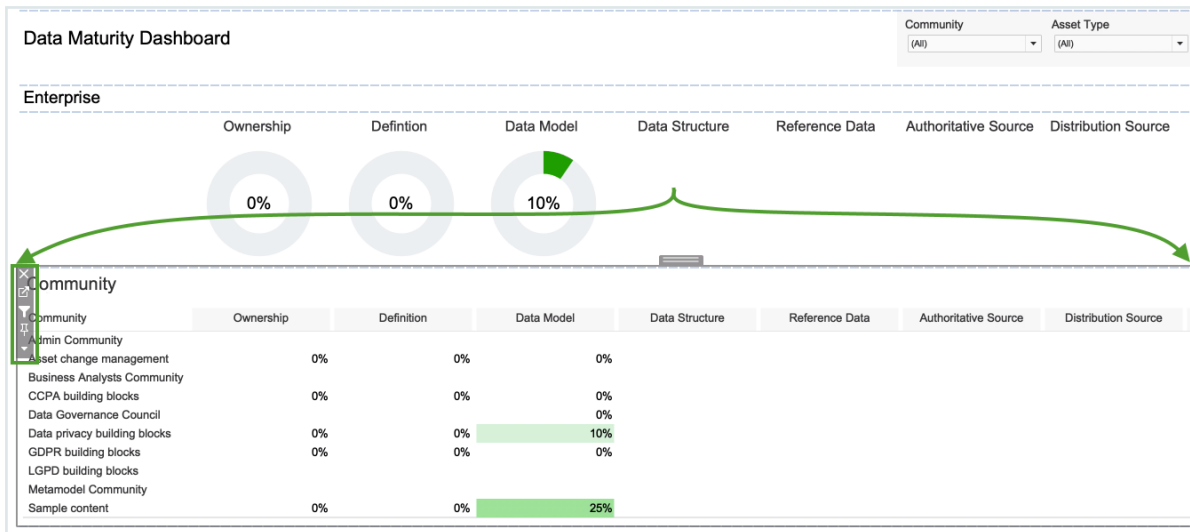
1. Click in the **Community** section, so that the entire section is highlighted.



2. Click the "go to sheet" icon .
 - » The Community data sheet opens.

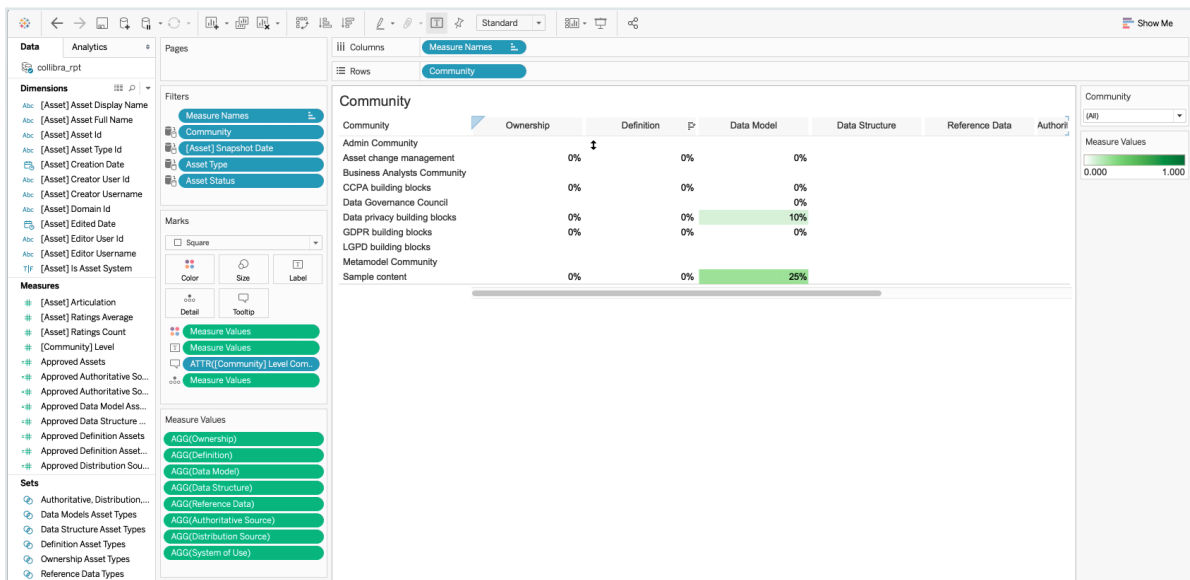

3. In the **Measure Values** section, select the measure that you want to edit. In this example, we selected Approved Definition Assets.

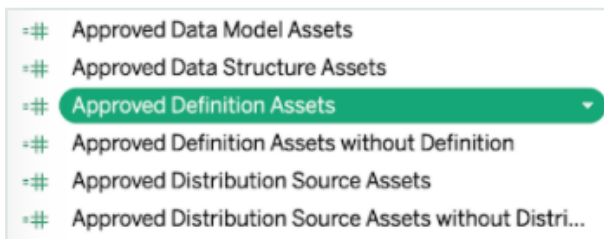

4. Right-click on the selected measure and select **Edit**.

5. In the calculation logic, change the asset status from "Approved" to the status you want, for example "Accepted".



6. Click OK.

Reporting Data Layer entity relationship diagram

The following Entity Relationship Diagram image shows how the different Reporting Data Layer tables can be linked. All tables contain both packaged and custom variants of the concept.

Note Nested communities can be identified via the parent-child relation. Subcommunities also have the ID of the community stored next to them.

To combine data for a given date, each table link clause must include the "snapshot_date".

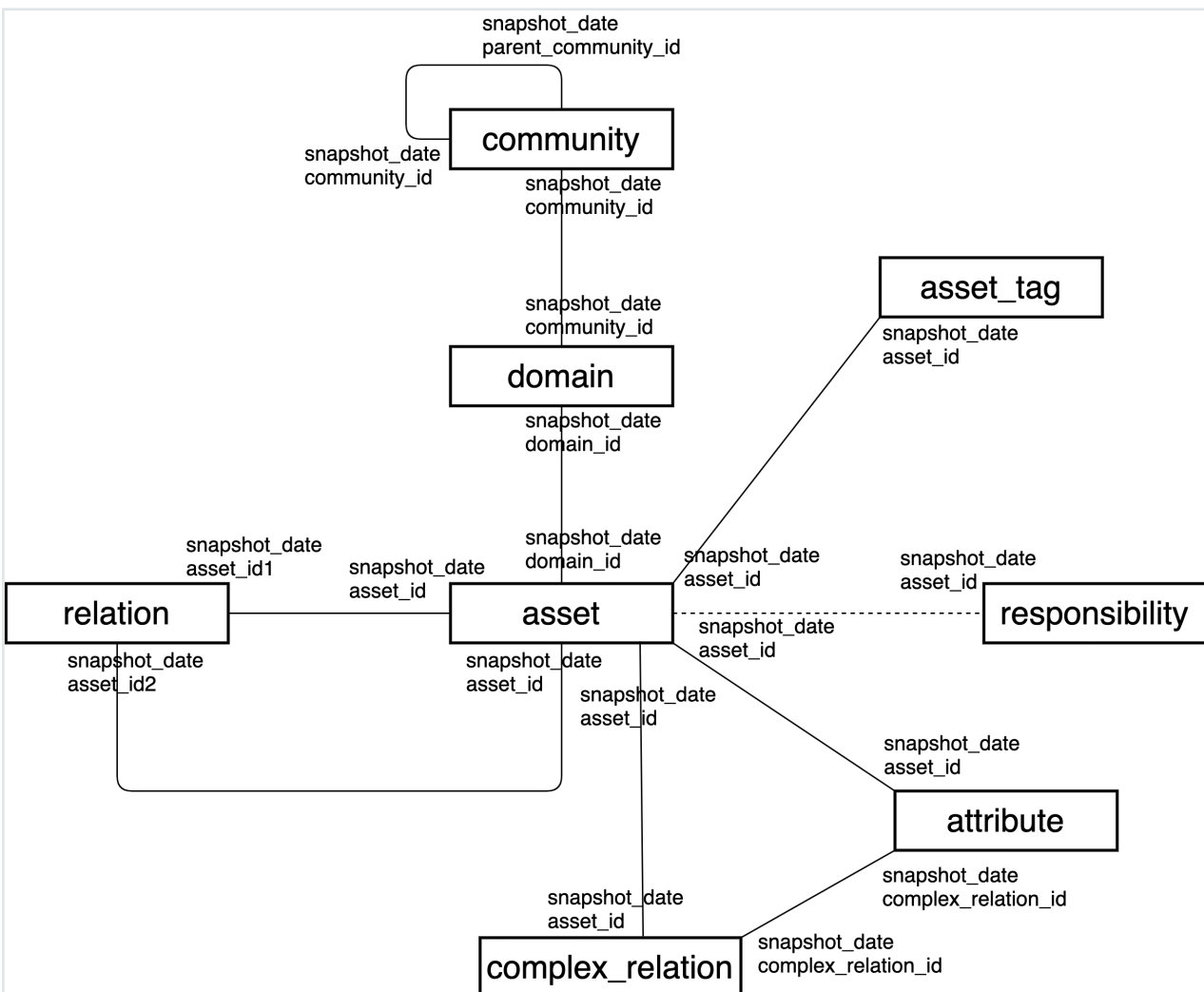

Tables

table_name	Description
Asset	Contains all of the assets in your Collibra Data Intelligence Cloud environment, including each asset's type and current status.
Asset_tag	Contains all of the tags attached to the assets in your Collibra environment.
Attribute	Contains all of the asset attributes in your Collibra environment.
Community	Contains all of the communities in your Collibra environment, including subcommunities and domains.
Complex_relation	Contains all of the relation legs for all of the complex relations in your Collibra environment.
Domain	Contains all of the domains in your Collibra environment that contain assets.
Relation	Contains all of the relations in your Collibra environment, from head to tail and vice versa.
Responsibility	<p>Contains all of the responsibilities in your Collibra environment that are directly assigned at the asset level or domain level.</p> <div style="background-color: #f0f0f0; padding: 10px; margin-top: 10px;"> <p>Note Inherited responsibilities from the community level are not included in the Reporting Data Layer.</p> </div>

Asset

column_name	ordinal_position	data_type	Description
snapshot_date	1	date	The date on which the snapshot was created. This is synchronized with the snapshot table.
asset_id	2	character varying	The resource UUID of the asset. This is a unique identifier.
asset_full_name	3	character varying	The full name of the asset.
asset_display_name	4	character varying	The display name of the asset.
domain_id	5	character varying	The resource UUID of the domain. This is a unique identifier.
asset_type_id	6	character varying	The resource UUID of the asset type. This is a unique identifier.
asset_type_name	7	character varying	The name of the asset type.
status_id	8	character varying	The resource UUID of the status.
status_name	9	character varying	The name of the status.
articulation	10	double precision	The articulation score of the asset.

column_name	ordinal_position	data_type	Description
ratings_average	11	double precision	The aggregated average of the ratings of the asset.
ratings_count	12	integer	The number of ratings of the asset.
is_asset_system	13	boolean	Indication whether the asset is a system asset.
creator_user_id	14	character varying	The UUID of the user who created the asset.
creator_username	15	character varying	The username of the user who created the asset.
creation_date	16	timestamp with time zone	The date on which the asset was created.
editor_user_id	17	character varying	The UUID of the user who last edited the asset.
editor_username	18	character varying	The username of the user who last edited the asset.
edited_date	19	timestamp with time zone	The date on which the asset was last edited.

Asset_tag

column_name	ordinal_position	data_type	Description
snapshot_date	1	date	The date on which the snapshot was created.

column_name	ordinal_position	data_type	Description
tag_id	2	character varying	The resource UUID of the tag attached to the asset.
asset_id	3	character varying	The resource UUID of the asset to which the tag is attached.
tag_name	4	character varying	The display name of the tag attached to the asset.
creator_user_id	5	character varying	The UUID of the user who created the tag.
creator_username	6	character varying	The username of the user who created the tag.
creation_date	7	timestamp with time zone	The date on which the tag was created.
editor_user_id	8	character varying	The UUID of the user who last edited the tag.
editor_username	9	character varying	The username of the user who last edited the tag.
edited_date	10	timestamp with time zone	The date on which the tag was last edited.
is_tag_system	11	boolean	Indication whether or not the tag is a system tag.

Attribute

column_name	ordinal_position	data_type	Description
snapshot_date	1	datetime	The date on which the snapshot was created. This is synchronized with the snapshot table.
attribute_id	2	character varying	The UUID of the attribute.
asset_id	3	character varying	The UUID of the related asset
asset_type_name	4	character varying	The name of the asset type of the relation asset.
attribute_type_id	5	character varying	The UUID of the attribute type.
attribute_type_name	6	character varying	The name of the attribute type.
attribute_type_description	7	character varying	The description of the attribute type.
kind	8	character varying	The kind of attribute.
is_attribute_integer	9	boolean	Indication whether the attribute is an integer.
expression_long	10	character varying	The value of the attribute.

column_name	ordinal_position	data_type	Description
boolean_value	11	boolean	The value of the attribute converted to a boolean.
datetime_value	12	datetime	The value of the attribute converted to date_time.
numeric_value	13	numeric	The value of the attribute converted to numeric.
creator_user_id	14	character varying	The UUID of the user who created the attribute.
creator_username	15	character varying	The username of the user who created the attribute.
creation_date	16	timestamp with time zone	The date on which the attribute was created.
editor_user_id	17	character varying	The UUID of the user who last edited the attribute.
editor_username	18	character varying	The username of the user who last edited the attribute.
edited_date	19	timestamp with time zone	The date on which the attribute was last edited.
complex_relation_id	20	character varying	The UUID of the complex relation for which the attribute is defined.

Community

column_name	ordinal_position	data_type	Description
snapshot_date	1	date	The date on which the snapshot was created. This is synchronized with the snapshot table.
community_id	2	character varying	The UUID of the community.
community_name	3	character varying	The name of the community.
community_description	4	text	The description of the community.
is_community_system	5	boolean	Indicator of whether the community is a system community.
uri	6	character varying	The URI of the community.
parent_community_id	7	character varying	The UUID of the community containing this community.
level	8	integer	The level of the community containing this community. The top level starts at 1.
level_community_id	9	character varying	The UUID of the community containing this community at a certain level.

column_name	ordinal_position	data_type	Description
level_community_name	10	character varying	The name of the community containing this community at a certain level.
level_community_description	11	text	The description of the community containing this community at a certain level.
level_community_uri	12	character varying	The URI of the community containing this community at a certain level.
creator_user_id	13	character varying	The UUID of the user who created the community.
creator_username	14	character varying	The username of the user who created the community.
creation_date	15	timestamp with time zone	The date on which the relation was edited.
editor_user_id	16	character varying	The UUID of the user who last edited the community.
editor_username	17	character varying	The username of the user who last edited the community.
edited_date	18	timestamp with time zone	The date on which the community was last edited.

Complex_relation

column_name	ordinal_position	data_type	Description
snapshot_date	1	date	The date on which the snapshot was created. This is synchronized with the snapshot table.
complex_relation_type_id	2	character varying	The UUID of the complex relation type.
complex_relation_type_name	3	character varying	The name of the complex relation type.
complex_relation_type_description	4	character varying	The description of the complex relation type.
complex_relation_id	5	character varying	The UUID of the complex relation.
relation_type_id	6	character varying	The UUID of the relation leg type.
relation_role	7	character varying	The role of the relation leg.
asset_id	8	character varying	The UUID of the related asset.
creator_user_id	9	character varying	The UUID of the user who created the complex relation.
creator_username	10	character varying	The username of the user who created the complex relation.

column_name	ordinal_position	data_type	Description
creation_date	11	timestamp with time zone	The date on which the complex relation was created.
editor_user_id	12	character varying	The UUID of the user who last edited the complex relation.
editor_username	13	character varying	The username of the user who last edited the complex relation.
edited_date	14	timestamp with time zone	The date on which the complex relation was last edited.

Domain

column_name	ordinal_position	data_type	Description
snapshot_date	1	date	The date on which the snapshot was created. This is synchronized with the snapshot table.
domain_id	2	character varying	The UUID of the domain.
domain_name	3	character varying	The name of the domain.
domain_description	4	text	The description of the domain.
domain_uri	5	character varying	The URI of the domain.

column_name	ordinal_position	data_type	Description
is_domain_system	6	boolean	Indicator of whether the domain is a system domain.
domain_type_id	7	character varying	The UUID of the domain type.
domain_type_name	8	character varying	The name of the domain type.
domain_type_description	9	character varying	The description of the domain type.
community_id	10	character varying	The UUID of the community.
creator_user_id	11	character varying	The UUID of the user who created the domain.
creator_username	12	character varying	The username of the user who created the domain.
creation_date	13	timestamp with time zone	The date on which the domain was created.
editor_user_id	14	character varying	The UUID of the user who last edited the domain.
editor_username	15	character varying	The username of the user who last edited the domain.
editor_date	16	timestamp with time zone	The date on which the domain was last edited.

Relation

column_name	ordinal_position	data_type	Description
snapshot_date	1	date	The date on which the snapshot was created. This is synchronized with the snapshot table.
relation_type_id	2	character varying	The UUID of the relation.
role_or_corole	3	character varying	The role of the relation in the direction from head to tail, co-role of the relation in the direction from head to tail.
direction	4	character varying	The direction of the relation. Can be either: <ul style="list-style-type: none"> • Head-to-tail, in which the first asset is the head and the second asset is the tail. • Tail-to-head, in which the first asset is the tail and the second asset is the head.
asset_id1	5	character varying	The UUID of the first asset in the relation.
asset_type_id1	6	character varying	The UUID of the asset type of the first asset in the relation.
asset_type_name1	7	character varying	The name of the asset type of the first asset in the relation.
asset_id2	8	character varying	The UUID of the second asset in the relation.

column_name	ordinal_position	data_type	Description
asset_type_id2	9	character varying	The UUID of the asset type of the second asset in the relation.
asset_type_name2	10	character varying	The name of the asset type of the second asset in the relation.
is_relation_generated	11	boolean	Indication whether the relation is generated.
creator_user_id	12	character varying	The UUID of the user who created the relation.
creator_username	13	character varying	The username of the user who created the relation.
creation_date	14	timestamp with time zone	The date on which the relation was created.
editor_user_id	15	character varying	The UUID of the user who last edited the relation.
editor_username	16	character varying	The username of the user who last edited the relation.
edited_date	17	timestamp with time zone	The date on which the relation was last edited.

Responsibility

column_name	ordinal_position	data_type	Description
snapshot_date	1	date	The date on which the snapshot was created. This is synchronized with the snapshot table.
role_id	2	character varying	The UUID of the role of the responsible user or user group.
role_name	3	character varying	The name of the resource role of the responsible user or user group.
asset_id	4	character varying	The UUID of the asset.
user_id	5	character varying	The UUID of the responsible user. This field is only used if the responsibility is assigned to a user.
username	6	character varying	The username of the responsible user. This field is only used if the responsibility is assigned to a user.
user_firstname	7	character varying	The first name of the responsible user. This field is only used if the responsibility is assigned to a user.
user_lastname	8	character varying	The last name of the responsible user. This field is only used if the responsibility is assigned to a user.

column_name	ordinal_position	data_type	Description
user_email	9	character varying	The username of the responsible user. This field is only used if the responsibility is assigned to a user.
user_language	10	character varying	The language of the responsible user. This field is only used if the responsibility is assigned to a user.
is_user_guest	12	boolean	Indication whether the responsible user is a guest user.
is_user_api	13	boolean	Indication whether the responsible user is an API user.
is_user_activated	14	boolean	Indication whether the responsible user's account is activated.
is_user_enabled	15	boolean	Indication whether the responsible user's account is enabled.
is_responsibility_system	16	boolean	Indication whether the responsibility is a system responsibility.
creator_user_id	17	character varying	The UUID of the user who created the responsibility.
creator_username	18	character varying	The username of the user who created the responsibility.
creation_date	19	timestamp with time zone	The date on which the responsibility was created.
editor_user_id	20	character varying	The UUID of the user who last edited the responsibility.

column_name	ordinal_position	data_type	Description
editor_username	21	character varying	The username of the user who last edited the responsibility.
edited_date	22	timestamp with time zone	The date on which the responsibility was last edited.
group_id	23	character varying	The UUID of the user group to which the responsibility is assigned.
group_name	24	character varying	The name of the user group to which the responsibility is assigned.

Remove non-applicable regulation placeholder from Privacy & Risk Readiness report

If you have purchased only one of the Collibra Data Privacy modules, CCPA or GDPR, you can remove the non-applicable placeholder from the report, as there will be no data to visualize.

Example In this example, the GDPR module was not purchased. Therefore, no GDPR-specific data is available.

EU General Data Protection Regulation (GDPR)
Regulation (EU) 2016/679 of the European Parliament and of the Council of 27 April 2016 on the protection of natural persons with regard to the processing of personal data and on the free movement of such data.

[View details](#)

Register Governance
The roles in the organisation responsible for privacy governance and stewardship.

Business Processes
The processing activities per business process that deal with personal data.

Controllers & Processors
Data controller determines the intend of processing personal data. Data processor processes personal data for the controller.

Steps

1. Click on the non-applicable regulation, so that the entire section is highlighted.

Privacy & Risk Readiness As on 26 August 2019

California Consumer Privacy Act (CCPA)
Bill (US) AB-375 of the California State Legislature of 23 September 2018 on privacy rights and consumer protection for the residents of California, United States.

[View details](#)

Inventory Governance
20%

Business Processes
10%

Businesses & Service Providers
10%

EU General Data Protection Regulation (GDPR)
Regulation (EU) 2016/679 of the European Parliament and of the Council of 27 April 2016 on the protection of natural persons with regard to the processing of personal data and on the free movement of such data.

[View details](#)

Register Governance
The roles in the organisation responsible for privacy governance and stewardship.

Business Processes
The processing activities per business process that deal with personal data.

Controllers & Processors
Data controller determines the intend of processing personal data. Data processor processes personal data for the controller.

2. Click .
3. Click **Delete Containers**, to confirm the deletion.

Dashboards

A dashboard is a page that provides a high level overview on different areas in the product. It is composed of one or several configurable [dashboard widgets](#), which can show text, a shortcut to the search, the organization browser, buttons to start a workflow and much more.

You can [create](#) as many dashboards as you want, each with a specific purpose. The default dashboard is the first page that you see when you sign in to Collibra Data Governance Center.

Permissions

No particular [license](#) is needed to manage and share your own dashboards; however, certain [global permissions](#) are needed.

Permission	With this global permission, you can...
Manage your own Views, Dashboards, Search filters	Create new dashboards or copy existing ones.
Share your own Views, Dashboards, Search filters	Share any of the dashboards you copied or created.
Manage and share anyone's Views, Dashboards, Search filters	<ul style="list-style-type: none">• Create new dashboards or copy existing ones.• Edit the properties of any dashboard.• Share any dashboard.• Delete any dashboard.



Create a dashboard



You can create a new [dashboard](#), and then [add](#) and [edit](#) widgets to suit your needs.

Tip You can create as many dashboards as you want without causing problems for Collibra DGC's performance.

Prerequisites

You have a [global role](#) with the Manage your own Views, Dashboards, Search filters [global permission](#), for example Sysadmin.

Steps

1. In the main menu, click .
2. In the dashboard toolbar, click  → **Add Dashboard**.
3. Enter the required information.

Property	Description
Name	The name of the dashboard.
Description	A description of the dashboard.
Layout	The layout of the dashboard. Select the number of columns for the dashboard.
Pin	Try to show this dashboard in the dashboard tab bar.

4. Click **Save**.

What's next?

You can now [add widgets](#) to your new dashboard.

Copy a dashboard



If, for example, you like the configuration of a certain [dashboard](#), but would like to reconfigure one of the [widgets](#) to better suit your needs, you can copy the dashboard, instead of [creating](#) a new one.

Tip You can create as many dashboards as you want without causing problems for Collibra DGC's performance.

Prerequisites

You have a [global role](#) with the Manage your own Views, Dashboards, Search filters [global permission](#), for example Sysadmin.

Steps

1. In the main menu, click .
2. In the dashboard toolbar, click  → **Save as**
3. Enter the required information.

Property	Description
Name	The name of the dashboard.
Description	A description of the dashboard.
Sharing options	Options to keep the dashboard private or share it.
Promote	Options that determine the location of the dashboard tab.
Default	Open this dashboard by default.
Pin	Try to show this dashboard in the dashboard tab bar.

4. Click **Save**.

What's next?

You can now edit the dashboard [properties](#) and [widgets](#) to suit your needs.



Edit the properties of a dashboard

You can edit the properties of a [dashboard](#), including the name, description and layout.

Prerequisites

- If you want to manage your own dashboard, you have a [global role](#) with the Manage your own Views, Dashboards, Search filters [global permission](#), for example Sysadmin.
- If you want to manage another user's dashboard, you have a global role with the Manage shared Views, Dashboard and Search Filter global permission, for example Sysadmin.

Steps

1. In the main menu, click .
2. If required, switch to the relevant dashboard.
3. In the dashboard toolbar, click  → **Edit properties**.
4. Enter the required information.

Property	Description
Name	The name of the dashboard.
Description	A description of the dashboard.
Layout	The layout of the dashboard. Select the number of columns for the dashboard.
Pin	Try to show this dashboard in the dashboard tab bar.

5. Click **Save**.

Switch to another dashboard

You can switch from one [dashboard](#) to another.

Steps

1. In the main menu, click .
2. In the dashboard toolbar, click the name of dashboard.



Share a dashboard

You can share a [dashboard](#) with other users if the [widgets](#) provide information that is useful to them.

Prerequisites

- If you want to share your own dashboard, you have a global role with the Share your own Views, Dashboards, Search filters [global permission](#), for example Sysadmin.
- If you want to share another user's dashboards, you have Manage shared Views, Dashboard and Search Filter [global permission](#).

Steps

1. In the main menu, click .
2. If required, switch to the relevant dashboard.
3. In the dashboard toolbar, click  → **Share**.
4. Select with whom you want to share the dashboard.
5. Specify whether or not you want to make the dashboard the default dashboard for the users with whom you are sharing it.
6. Click **Save**.



Delete a dashboard

If a [dashboard](#) is no longer useful, you can delete it.

Prerequisites

- If you want to manage your own dashboard, you have a [global role](#) with the Manage your own Views, Dashboards, Search filters [global permission](#), for example Sysadmin.
- If you want to manage another user's dashboard, you have a global role with the Manage shared Views, Dashboard and Search Filter global permission, for example Sysadmin.

Steps

1. In the main menu, click .
2. If required, switch to the relevant dashboard.
3. In the dashboard toolbar, click  → **Delete**.
4. Click **Yes**.

Dashboard widgets

A dashboard widget is an individual pane in a [dashboard](#). Depending on its type, it has a different purpose. For example, it can contain quick links to important or useful information, statistics in a bar chart or a button to quickly start a workflow.

Widgets

Collibra Data Governance Center comes with the following widgets:

Widget	Description
Bar Chart	Asset or task metrics depicted in a bar chart.
Search	A search field by which users can search for resources.
Text	A block of text, or message.

Widget	Description
Counters	Asset or task metrics depicted by a graphic element with the total count.
Workflow	A collection of workflow buttons by which users can start workflows.
To Do	An overview of open tasks and issues.
Browser	A hierarchical tree-structure of all communities, subcommunities and domains.
Most Viewed	A list of the ten most viewed assets over the last week, month or year.
Recent	A list of your ten most recently viewed assets.

For complete information on adding and editing dashboard widgets, see the Documentation Center.

The Widgets tab

All widgets have:

- A specific tab for configuring and editing the widget.
- The **Widget** tab, which is common to all widgets and contains the common configuration options.

Field	Explanation
Show title above the widget	<ul style="list-style-type: none"> • True: A title is shown above the widget. In this case, specify a title. • False: No title is shown above the widget.
Show description above the widget	<ul style="list-style-type: none"> • True: A description is shown above the widget. In this case, the packaged description is shown. • False: No description is shown above the widget.

Field	Explanation
Refresh every	<ul style="list-style-type: none"> • True: The counter is refreshed according to the refresh rate you specify. In this case, specify the refresh rate. Possible values are: 5, 10, 25, 50 or 100 minutes. • False: The counter is not automatically refreshed.

Example

Bar chart widget

The Bar Chart widget enables you to display advanced metrics in the form of a bar chart.

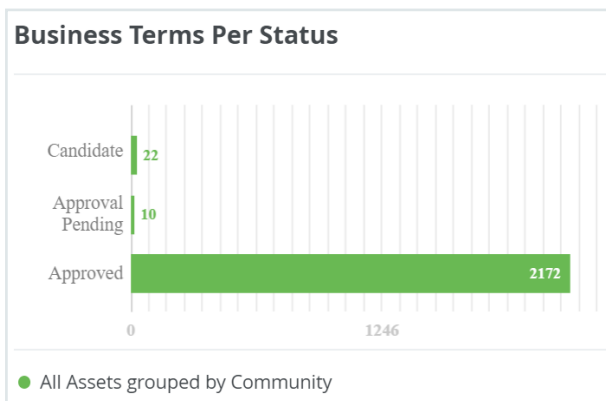



Configure a bar chart

You can add many different bar charts to the dashboard and configure them to suit your needs.

Prerequisites

- If you want to manage your own dashboard, you have a [global role](#) with the Manage your own Views, Dashboards, Search filters [global permission](#), for example Sysadmin.
- If you want to manage another user's dashboard, you have a global role with the Manage shared Views, Dashboard and Search Filter global permission, for example Sysadmin.

Steps

1. In the main menu, click .
2. If required, switch to the relevant dashboard.
3. In the dashboard toolbar, click  → **Edit widgets**.
4. If required, [add](#) a **Bar Chart** widget to a dashboard.
5. In the widget, click .
6. On the **Graph** tab, click **Create Template**.
7. In the **Bar Chart Configuration** wizard, click the type of data that you want to use.
 - **Assets**: If you want to display metric information about assets.
 - **Tasks**: If you want to display metric information about tasks.
8. In the **by** field, select how the data is grouped.

Note If you group by Attribute Value, you can only select "Boolean" or "Selection" characteristic types.

This setting defines how the bars in the bar chart, also known as groups, are constructed. Depending on what you select, additional fields are shown.

9. Optionally, add up to 25 sets of filtered data:
 - a. Click **Add Data Set**.
 - b. In the **Filter Label** field, fill in a label name for the bar chart legend.
This field is mandatory.
Example: *Business terms*

- c. In the row under the **Filter Label** field, specify a filter.
Example: *Asset Type equals Business Term*.
 - d. Click **Save**.
 - e. To add more data filters, repeat steps a - d.
10. Click **Next**.
 11. Provide a template name.
 12. Select how the items in the bar chart are ordered:
 - Alphabetical.
 - Numerical, meaning that the groups are sorted by their value (the length of the bar).
 If necessary, select a graph type.
 13. Click **Save & Apply**.

Search widget

The Search widget on the dashboard is similar to the [Search field](#) in the main menu. If you type something and press `Enter`, the same [search page](#) is shown as if you searched via the **Search** field, and the search results are the same. The difference is that the Search widget does not show the most recently viewed resources or, while you are typing, the top results, as does the **Search** field.

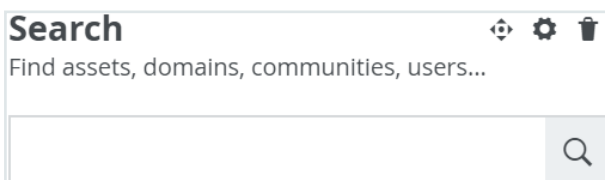

If the **Search** widget is not included on your dashboard, you can [add](#) it.

Text widget

The Text widget is a free-text field that allows you to add text to the dashboard. You can use it, for example, to inform users your latest data governance news, point users to certain pages with hyperlinks to a specific view and so on.

When you add content to a Text widget, you can:

- Use the rich text editor in the **Content** tab, to format your text.
- Click `<>`, to edit the HTML source code.

Warning

The text editor supports most HTML elements, inline CSS styling and table (< t >) structures. However, this means an attacker could potentially execute an XSS attack by injecting malicious HTML. However, you can automatically remove the following HTML elements to improve security:

- script
- svg
- frame
- frameset
- iframe
- any event handlers
- any JavaScript

You can enable this in Collibra Console. For more information, see the [Troubleshooting section](#).



Configure the Text widget

You can configure the Text widget to post a free-text message on the dashboard.

Prerequisites

- If you want to manage your own dashboard, you have a [global role](#) with the Manage your own Views, Dashboards, Search filters [global permission](#), for example Sysadmin.
- If you want to manage another user's dashboard, you have a global role with the Manage shared Views, Dashboard and Search Filter global permission, for example Sysadmin.

Steps

1. In the main menu, click .
2. If required, switch to the relevant dashboard.
3. In the dashboard toolbar, click  → **Edit widgets**.

4. If required, **add** a **Text** widget to a dashboard.
5. In the widget, click .
6. Type or cut and paste your text in the field and, optionally, format it using the rich text editor.

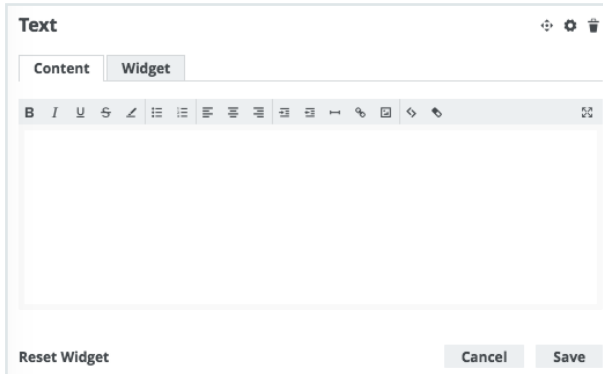

Tip If you want to copy and paste text from other sources into a text field, we recommend that you click , and then paste the text into the **Show source code** field. This will remove any unwanted formatting or tagging of the text. For detailed information, see the knowledge base article on [Collibra Support Portal](#).

7. Click **Save**.

Supported HTML tags

The following table shows the HTML tags you can use to format your text in the Text widget:

Supported HTML tags					
meta	option	small	font	dl	input
head	textarea	big	a	dt	select
title	h1	pre	map	em	strong
script	h2	code	style	table	col
noscript	h3	cite	span	td	br

Supported HTML tags					
svg	h4	samp	div	th	tfoot
iframe	h5	sub	img	tr	thead
frameset	h6	sup	link	colgroup	tbody
frame	p	strike	ul	col	
label	i	center	ol	fieldset	
form	b	blockquote	li	legend	
button	u	hr	dd	no-hyperlink	

Counters widget

The Counters widget shows count statistics on your dashboard and the Metrics pages of the Collibra applications, for example the number of total assets in your environment or the number of open tasks or issues.

When configuring a Counter widget, you choose from a fixed list of templates that determine the count statistics that are computed. The following table describes the computation for each template:

Template name	Description
Applications	Number of Technology Assets.
Approved Assets	Number of assets with the status "Accepted".
Assets	Number of assets.

Template name	Description
Assets Created Past Day	Number of assets created in the past day (24 hours).
Assets Created Past Month	Number of assets created in the past month (28 days).
Assets Created Past Week	Number of assets created in the past week (7 days).
Business Terms	Number of Business Term assets.
Code Values	Number of Code Value assets.
Columns	Number of Column assets.
Communities	Number of communities.
Data Assets	Number of Data Assets.
Domains	Number of domains.
File Groups	Number of File Group assets.
Files	Number of File assets.
Governance Assets	Number of Governance Assets.

Template name	Description
Issues resolved past day	<p>Number of Issue assets for which the status became "Resolved" within the past day (24 hours).</p> <div data-bbox="432 501 1417 842" style="border: 1px solid #ccc; padding: 10px; margin-top: 10px;"> <p>Note This counter does not show how many Issue assets were set to "Resolved" in the past 24 hours. Rather, it shows the total number of Issue assets that had the "Resolved" status at a specific point in time. By default, the Issue assets are counted once every 24 hours. The counting interval can be edited in Collibra Console. Keep in mind that increasing the frequency of the counts may negatively impact performance.</p> </div>
Issues resolved past week	<p>Number of Issue assets for which the status became "Resolved" within the past week (7 days).</p> <div data-bbox="432 1003 1417 1344" style="border: 1px solid #ccc; padding: 10px; margin-top: 10px;"> <p>Note This counter does not show how many Issue assets were set to "Resolved" in the past 7 days. Rather, it shows the total number of Issue assets that had the "Resolved" status at a specific point in time. By default, the Issue assets are counted once every 7 days. The counting interval can be edited in Collibra Console. Keep in mind that increasing the frequency of the counts may negatively impact performance.</p> </div>
KPIs	Number of Key Performance Indicators.
My Open Tasks	<p>Total number of unfinished tasks for the user.</p> <div data-bbox="432 1547 1417 1686" style="border: 1px solid #ccc; padding: 10px; margin-top: 10px;"> <p>Note "Unfinished" is the status of the task, as documented in the workflow.</p> </div>
New Issues	Number of Issue assets with the status "New".

Template name	Description
Open Issues	<p>Number of unresolved Issue assets. Unresolved Issue assets can have the following statuses:</p> <ul style="list-style-type: none"> • New • Under Review • Accepted • Invalid • In Progress • Resolution Pending • Pending
Open Tasks	<p>Number of unfinished tasks for all users.</p> <div style="border: 1px solid #ccc; background-color: #f0f0f0; padding: 10px; margin-top: 10px;"> <p>Note "Unfinished" is the status of the task, as documented in the workflow.</p> </div>
Processes	Number of Business Process assets.
Reference Data Domains	Number of Code-list domains.
Reports	Number of Report assets.
S3 Buckets	Number of S3 Bucket assets.
S3 File Systems	Number of S3 File System assets.
Schemas	Number of Schema assets.
Tableau Dashboards	Number of Tableau Dashboard assets.

Template name	Description
Tableau Projects	Number of Tableau Project assets.
Tableau Servers	Number of Tableau Server assets.
Tableau Sites	Number of Tableau Site assets.
Tableau Stories	Number Tableau Story assets.
Tableau Views	Number of Tableau View assets.
Tableau Workbooks	Number Tableau Workbook assets.
Tables	Number of Table assets.
Task Duration	Sum of all task durations.
Users	Number of users currently signed in to the environment.

Configure the Counters widget



You can add many different counters to the dashboard and configure them to suit your needs.

Prerequisites

- If you want to manage your own dashboard, you have a [global role](#) with the Manage your own Views, Dashboards, Search filters [global permission](#), for example Sysadmin.

- If you want to manage another user's dashboard, you have a global role with the Manage shared Views, Dashboard and Search Filter global permission, for example Sysadmin.

Steps

1. In the main menu, click .
2. If required, switch to the relevant dashboard.
3. In the dashboard toolbar, click  → **Edit widgets**.
4. If required, [add](#) a **Counters** widget to a dashboard.
5. In the widget, click .
6. Enter the required information.

Counters Widget

ui.core.businessterms

Template
Business Terms

Warning Level ■

Danger Level ■

URL
glossary

Add Counter

[Reset Widget](#)

7. Click **Save**.

Warning and danger thresholds

The warning and danger thresholds are optional settings that allow you to visually communicate certain risk or tolerance levels for Issue assets.

The two threshold settings, "Warning level" and "Danger level", can be configured:

- Per counter.
- Alone or in combination with one another.

Note The threshold settings are designed for use with the following issue-related templates:

- New Issues
- Open Issues
- Issues resolved past day
- Issues resolved pas week

Example

Let's say that your organization has established that 20 open issues (meaning Issue assets with a status other than "Resolved") exceeds its risk appetite. To give this visibility within the appropriate community of Collibra DGC users, you **add** the Counters widget to the dashboard, and **configure** a counter to show the number of open issues, of which there are currently 13.

In accordance with your organization's risk appetite, and to give more meaning to the number of open issues, you set **Warning Level** to 10 and **Danger Level** to 20.

Configuration interface for a Counter widget:

- Widget ID: ui.core.openissues
- Template: Open Issues
- Warning Level: 10 (Yellow icon)
- Danger Level: 20 (Red icon)
- URL: data-helpdesk

The following example image shows the resulting Counters widget and, specifically, the Open Issues counter:

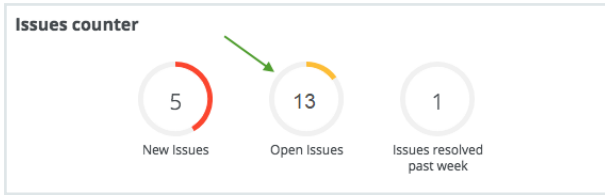

Understanding the color bands

When values are given to one or both of the threshold settings, the band around the counter will be green, orange or red. The colors have the following meanings:

Circle color	Meaning
Entirely gray	No value has been set for either the warning or danger thresholds.
Green	The issue count is lower than both threshold values, or if only one threshold has been set, lower than that value.
Orange	The issue count is higher than the warning threshold value, but lower than the danger threshold value (if the danger threshold has been set).
Red	The issue count is higher than the warning threshold value (if no danger threshold has been set) or higher than the danger threshold value, if it has been set.

Workflow widget

The Workflow widget adds one or more buttons to the dashboard, allowing users to start global workflows from the dashboard.

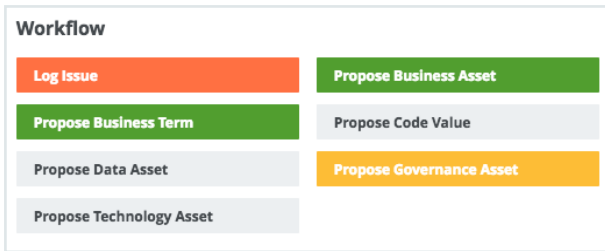

When you customize this widget, there is a **Buttons** tab instead of a **Content** tab. You can specify which workflows have to be available and how they are displayed.

You can specify the following parameters for each button:

1. The label to display on the button
2. The global workflow that is started by clicking the button
3. The styling of the button



Configure the Workflow widget

You can add and configure buttons for any enabled workflow.

Prerequisites

- If you want to manage your own dashboard, you have a [global role](#) with the Manage your own Views, Dashboards, Search filters [global permission](#), for example Sysadmin.
- If you want to manage another user's dashboard, you have a global role with the Manage shared Views, Dashboard and Search Filter global permission, for example Sysadmin.

Steps

1. In the main menu, click .
2. If required, switch to the relevant dashboard.
3. In the dashboard toolbar, click  → **Edit widgets**.
4. If required, [add](#) a **Workflow** widget to a dashboard.
5. In the widget, click .

6. Enter the required information.

Tab	Field	Description
Buttons	1	The button text.
	2	The workflow that will be started when a user clicks the button.
	3	<p>The color of the button, based on the type of workflow. Possible values and their associated colors are as follows:</p> <ul style="list-style-type: none"> ○ Default: gray ○ Danger: red ○ Info: gray ○ Success: green ○ Warning: yellow <p>Note This field only determines the color of the button. It has no bearing on the workflow.</p>

7. Click **Save**.

To Do widget

The To Do widget provides a quick overview of open tasks and issues. You can:

- Click the **Tasks** and **Issues** buttons, to switch between tasks and issues.
- Click ▼ in the drop-down list, to sort the tasks by due date, asset and title.
- Click **Show All**, to go to the [My Tasks page](#), where all tasks are shown.

To Do
Get a list of all tasks/issues or just the ones assigned to you

5 Tasks
Issues 1
Due Date ▾

Rejected Definition 7 months ago
For **Chat Log Data Standard**
Correct the definition after it was rejected by System.

Assign Technical steward in 14 days
For **All Data-2**
Please assign a Technical Steward to the domain.

Assign Technical steward in 21 days
For **Worldwide-co2-emissions3**
Please assign a Technical Steward to the domain.

Assign Technical steward in 21 days
For **Worldwide-co2-emissions 2**
Please assign a Technical Steward to the domain.

Assign Technical steward in 21 days
For **Global-migration 2**
Please assign a Technical Steward to the domain.

◀ Show All

Tip If there are several tasks or issues shown in the widget, you can vertically resize the widget, to see more items without having to scroll as much in the widget. To resize the widget, click the gray, bi-directional arrow at the bottom of the widget and drag it to size.

To Do ⊞ ⊞ ⊞ ⊞
Get a list of all tasks/issues or just the ones assigned to you

4 Tasks
Issues 1
Due Date ▾

Review in a month

For **Accuracy**
Please review the Data Quality Dimension.

◀ Show All

⬆

Note Issues with the following statuses are not included in the list of open issues:

- Resolved
- Invalid
- Obsolete
- Disabled

You cannot add to, or remove, these excluded statuses. This means that if you create your own statuses, you cannot add them to the excluded statuses.

Configure the To Do widget



You can configure the widget to show either:

- Only tasks that are assigned to you and open issues that you have created.
- All open tasks and issues across your Collibra DGC environment.

Prerequisites

- If you want to manage your own dashboard, you have a [global role](#) with the Manage your own Views, Dashboards, Search filters [global permission](#), for example Sysadmin.
- If you want to manage another user's dashboard, you have a global role with the Manage shared Views, Dashboard and Search Filter global permission, for example Sysadmin.

Steps

1. In the main menu, click .
2. If required, switch to the relevant dashboard.
3. In the dashboard toolbar, click  → **Edit widgets**.
4. If required, [add](#) a **To Do** widget to a dashboard.
5. In the widget, click .
6. Enter the required information.

Tab	Field	Explanation
Tasks	Show tasks	<ul style="list-style-type: none"> ◦ True: Show tasks in the widget. In this case, specify whether to show all tasks or only tasks assigned to you. ◦ False: Tasks are not shown in the widget.
	Show maximum	<ul style="list-style-type: none"> ◦ True: Limit the number of tasks shown in the widget. In this case, specify the maximum number of tasks that can be shown. Possible values are: 5, 10, 15, 20, 25, 50 or 100. ◦ False: There is no limit to the number of tasks that can be shown.
Issues	Show issues	<ul style="list-style-type: none"> ◦ True: Show issues in the widget. In this case, specify whether to show all open issues or only open issues that you created. ◦ False: Issues are not shown in the widget.
	Show maximum	<ul style="list-style-type: none"> ◦ True: Limit the number of issues shown in the widget. In this case, specify the maximum number of issues that can be shown. Possible values are: 5, 10, 15, 20, 25, 50 or 100. ◦ False: There is no limit to the number of issues that can be shown.

7. Click **Save**.

Browser widget

The Browser widget enables you to browse through the available communities and domains, via the dashboard.

You can use the search field at the top of the widget, to quickly find communities and domains.

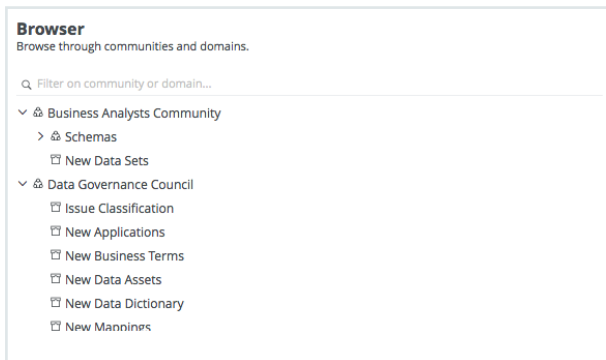

This widget has no specific configuration settings. Like all other widgets, common configuration settings are available via the [Widgets tab](#).

Tip You can also click the company logo at the top left-hand corner, to [Navigating through domains and communities](#) via the Organization Browser.

Most Viewed widget

The Most Viewed widget shows the ten most viewed assets over a specified time range.

The domain for each asset is shown under the asset name. You can:

- Click an asset name to go to that asset page.
- Click a domain name to go to that domain page.

Most Viewed	
1	Accuracy Data Quality Dimensions
2	postg postg
3	Duplication Data Quality Dimensions
4	amazon domi amazon domi
5	col8 amazon domi
6	a New Business Terms
7	country amazon domi
8	price amazon domi
9	Completeness Data Quality Dimensions
10	aaa > ee Movie Metadata-kopia



Configure the Most Viewed widget

You can configure the widget to show the ten most viewed assets over the last week, month or year.

Prerequisites

- If you want to manage your own dashboard, you have a [global role](#) with the Manage your own Views, Dashboards, Search filters [global permission](#), for example Sysadmin.
- If you want to manage another user's dashboard, you have a global role with the Manage shared Views, Dashboard and Search Filter global permission, for example Sysadmin.

Steps

1. In the main menu, click .
2. If required, switch to the relevant dashboard.
3. In the dashboard toolbar, click  → **Edit widgets**.
4. If required, [add](#) a **Most Viewed** widget to a dashboard.

- In the widget, click .
- Select the time range over which to show the most viewed assets: last week, last month or last year.

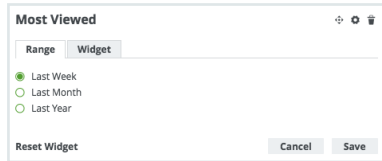

- Click **Save**.

Recent widget

The Recent widget shows your ten most recently viewed assets.

The domain for each asset is shown under the asset name. You can:

- Click an asset name to go to that asset page.
- Click a domain name to go to that domain page.

Recent		
price	amazon domi	17 m ago
Duplication	Data Quality Dimensions	17 m ago
country	amazon domi	19 m ago
price	amazon domi	20 m ago
Consistency	Data Quality Dimensions	21 m ago
Completeness	Data Quality Dimensions	21 m ago
col8	amazon domi	21 m ago
whole_number_string_80	amazon domi	22 m ago
aaa > ee	Movie Metadata-kopia	22 m ago
a	New Business Terms	28 m ago

This widget has no specific configuration settings. Like all other widgets, common configuration settings are available via the [Widgets tab](#).



Add a widget to a dashboard

You can add widgets to curate information-rich dashboards.

Prerequisites

- If you want to manage your own dashboard, you have a [global role](#) with the Manage your own Views, Dashboards, Search filters [global permission](#), for example Sysadmin.
- If you want to manage another user's dashboard, you have a global role with the Manage shared Views, Dashboard and Search Filter global permission, for example Sysadmin.

Steps

1. In the main menu, click .
2. If required, switch to the relevant dashboard.
3. In the dashboard toolbar, click  → **Edit widgets**.
4. Click a widget and drag it onto the dashboard.

You can browse through the widgets by using the page numbers below them.

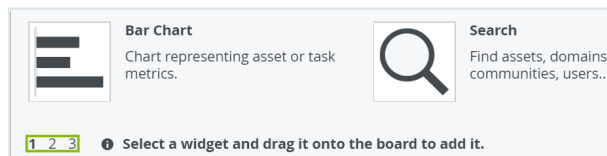

5. [Edit a widget](#) as required.
6. Click **Close & save edits**.



Move a widget

You can move a widget if you feel like a widget belongs in a different location on the dashboard.

Prerequisites

- If you want to manage your own dashboard, you have a [global role](#) with the Manage your own Views, Dashboards, Search filters [global permission](#), for example Sysadmin.
- If you want to manage another user's dashboard, you have a global role with the Manage shared Views, Dashboard and Search Filter global permission, for example Sysadmin.

Steps

1. In the main menu, click .
2. In the view bar, select the dashboard that you want to change. See [Switch to another dashboard](#).
3. In the dashboard toolbar, click  → **Edit widgets**.
4. Click  and hold the button (move) on the widget that you want to move.
5. Drag the widget to where you want it on the dashboard and release the mouse button.
6. Click **Close & save edits**.



Edit a widget

You can edit the dashboard widgets to curate the information shown on the dashboard.

Prerequisites

- If you want to manage your own dashboard, you have a [global role](#) with the Manage your own Views, Dashboards, Search filters [global permission](#), for example Sysadmin.
- If you want to manage another user's dashboard, you have a global role with the Manage shared Views, Dashboard and Search Filter global permission, for example Sysadmin.

Steps

1. In the main menu, click .
2. If required, switch to the relevant dashboard.
3. In the dashboard toolbar, click  → **Edit widgets**.
4. Edit the content of the widget, to meet your needs.

Note

- Not every widget has the same tabs.
- The **Widget** tab is the same for each widget. Your configuration of the **Widget** tab defines how the widget is displayed on the dashboard.

Tip You can vertically resize any dashboard widget, by clicking and dragging the gray, bi-directional arrow at the bottom of the widget.

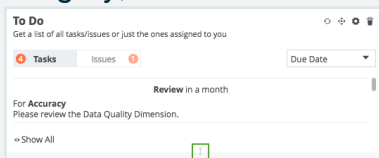

5. Click **Save**.

For complete information on working with dashboards and widgets, see the [Collibra Data Governance Center User Guide](#).

Delete a widget from a dashboard



If a specific widget is no longer useful on a certain dashboard, you can delete it from that dashboard.

Prerequisites

- If you want to manage your own dashboard, you have a [global role](#) with the Manage your own Views, Dashboards, Search filters [global permission](#), for example Sysadmin.

- If you want to manage another user's dashboard, you have a global role with the Manage shared Views, Dashboard and Search Filter global permission, for example Sysadmin.

Steps

1. In the main menu, click .
2. If required, switch to the relevant dashboard.
3. In the dashboard toolbar, click  → **Edit widgets**.
4. In the widget, click .
5. Click **Delete** to confirm.
6. Click **Close & save edits**.

Data Helpdesk

With the Data Helpdesk application of Collibra Data Governance Center, you can:

- Manage **data issues**¹ efficiently.
- Quickly view newly created issues.
- Process issues assigned to a given user.
- Track the progress of the issues.
- View the data quality dimensions (accuracy, completeness, conformity, consistency, integrity are available out of the box) and the data quality rules.

The following sections describe the issue roles, how to log issues and how to use the default 'Issue Management' workflow. Note that since administrators can change and customize the workflow, the actual behavior of your Collibra DGC may be different than described.

Data Helpdesk submenu pages

Page	Description
Issues	Contains a table with Issue assets in Collibra DGC.
Data Quality	Contains tables with Data Quality and Data Quality Dimension assets.
Metrics	Contains a variety of statistics related to how the assets of the Data Helpdesk are used.

In this chapter

¹A problem related to issue management; also referred to as issue.

Packaged metamodel for the Data Helpdesk

The Data Helpdesk has specific asset types and domain types.

Asset types

The table below contains the packaged [asset types](#) that are relevant for the Data Helpdesk.

Domain types

The table below contains the packaged [domain types](#) that are relevant for the Data Helpdesk.

Workflows

The table below contains the packaged workflows that are relevant for the Data Helpdesk.

Name	Description
Assessments	This process notifies the Business Steward (by default) that an Assessment Review asset is ready for review and prompts the Business Steward to approve or reject the asset.
Cancel Process	This process notifies the concerned users of a workflow cancellation.
Escalation Process	This process is the default mechanism for the escalation of user tasks in workflows.
Issue Creation	This process facilitates issue creation.

Name	Description
Issue Management	This process is used to route and resolve issues.
Issue Move	The Issue Move workflow is a process that changes the responsible community of an issue.
Propose New Governance Asset	This process facilitates the creation of new Governance Assets in the Data Governance Council community.
Simple Approval	The Simple Approval workflow is a single-step process that allows you to approve an asset in Collibra Data Governance Center.
Voting Sub-Process	<p>The Voting Sub-Process is a workflow that can be called by other workflows when users need to vote. It is used within other packaged workflows such as the Approval Process, the Simple Approval or the Issue Management workflow.</p> <p>You can use this sub-process in new custom workflows. The result is a true or false boolean that is provided to the parent workflow.</p>

Issue roles

There are several roles involved in the issue management workflow. Some of the roles are assigned automatically by the workflow and others have to be configured or assigned while tasks of the workflow are being executed. Predefined variables can determine which users to select for a given situation. To learn more about configuring variables for workflows, see the [Workflow Documentation](#) in the [Collibra Developer Portal](#).

The following table contains the different roles in an issue.

Role	Description
Requester	The requester is the user who has logged an issue, which means that there can only be one requester per issue. The requester is kept up to date on the issue resolution progress and can be asked to provide more information.
Reviewer	<p>The reviewer analyzes the created issue and proposes a solution for it but does not implement the solution. The reviewer is responsible to ensure that all the information is available for solving the issue. This user can also mark an issue as invalid.</p> <p>Which user is assigned as reviewer, depends on the issue management workflow configuration. The reviewerUserExpression variable of the workflow determines which users are able to assign themselves as reviewer for the issue. By default this is the steward. After the workflow has started, the issue manager or the current reviewer can assign a different user as reviewer.</p>
Stakeholder	The stakeholders of an issue are responsible for accepting or rejecting the analysis and solution that was proposed by the reviewer. The stakeholders of an issue can be configured through a variable called the stakeholderUserExpression in the workflow. By default, this is the steward. It is not possible to change the stakeholders after the workflow has started.

Role	Description
Assignee	<p>The assignee is responsible for the actual implementation of the solution. It is the requester's responsibility to appoint assignees. The assignee receives a task for the implementation of the solution.</p> <p>Assignees are suggested by the workflow. The suggested assignees can be configured through the assigneeUserExpression variable of the workflow. Assignees can also assign another assignee after the workflow has started.</p>

Create a data issue

By creating a new data issue, you start a workflow to resolve data issues. The workflow behavior varies per company.

Steps

To create a data issue, follow these steps:

1. In the main menu, click the **Create (+)** button.
 - » The **Create** dialog box appears.
2. In the **Create** dialog box, click the **Actions** tab.
3. Click **Issue Creation**.

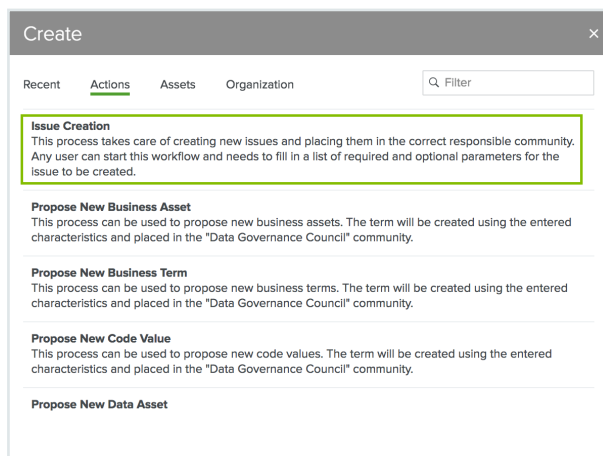

If you don't see **Issue Creation**, you have to add the **Issue Creation** workflow to the global create, see [I don't see a workflow in the global create](#).

4. Complete the **Log Issue** dialog box.

- **Title** (mandatory): The name and a short descriptive title for the issue.
- **Description** (mandatory): A full description to explain the details of the issue.
- **Priority**: The priority of the issue. Possible values are (in order of importance from high to low):
 - Blocking
 - Critical
 - Urgent
 - Normal
 - Minor
- **Responsible Community**: The community that is, according to you, responsible for solving the issue. By default, this is the Data Governance Council community, which is responsible for taking in all new types of assets and assigning them to the right community.
- **Relevant Assets**: A list of assets that are impacted by the issue. When you start typing in this field, suggestions appear. Click a suggestion to add the asset to the issue. You can add multiple relevant assets.

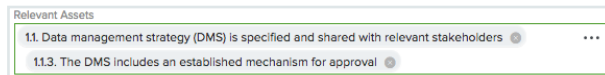

Click **x** next to a related asset to remove it from the list.

5. Click **Create Issue**.



Example:

What's next?

The data issue is created and the proper workflow is automatically started. On the **Diagram** page of the created Data Issue asset page, you can find the assets that are related to the issue.

Create issue: options

Option	Description
Title	<p>Mandatory.</p> <p>The name and a short descriptive title for the issue.</p>
Description	<p>Mandatory.</p> <p>A full description to explain the details of the issue.</p>

Option	Description
Priority	<p>The priority of the issue. Possible values are (in order of importance from high to low):</p> <ul style="list-style-type: none"> • Blocking • Critical • Urgent • Normal • Minor
Responsible Community	<p>The community that is, according to the reporter, responsible for solving the issue. By default, this is the Data Governance Council community, which is responsible for taking in all new types of assets and assigning them to the right community.</p>
Relevant Asset	<p>A list of assets that are impacted by the issue or that are subject of the issue. When you start typing in this field, suggestions appear. Click a suggestion to add the asset to the issue. You can add multiple relevant assets.</p>  <p>Click  next to a related asset to remove it from the list.</p>
Issue Classification	<p>The classification of the issue, indicating what the issue type is.</p>

Tasks in the Issue Management workflow

In this section you can find more information about the various tasks in the Issue Management workflow. For more information about workflows, see [Managing workflows in Collibra DGC](#) section.

Note It is possible that your Collibra Data Governance Center administrator has renamed the Issue Management workflow.

Accepting or rejecting a data issue

When the issue management workflow is started, tasks are assigned to the users that are defined in the workflow. These are by default the issue stewards. This workflow task has to be completed before a predefined deadline, if not, the issue is escalated to the issue manager who will set a reviewer manually.

The stewards can accept or reject an issue. When one steward accepts the issue, its status becomes **Under Review**.

Only when all stewards reject an issue, the issue is marked as invalid and the requester is notified.

You can check if you have issues to accept or reject if you click the **Tasks** button in the main menu. Issues that have passed the due date, appear in red.

Click on the task row to select it. You can accept or reject the task from the sidebar.

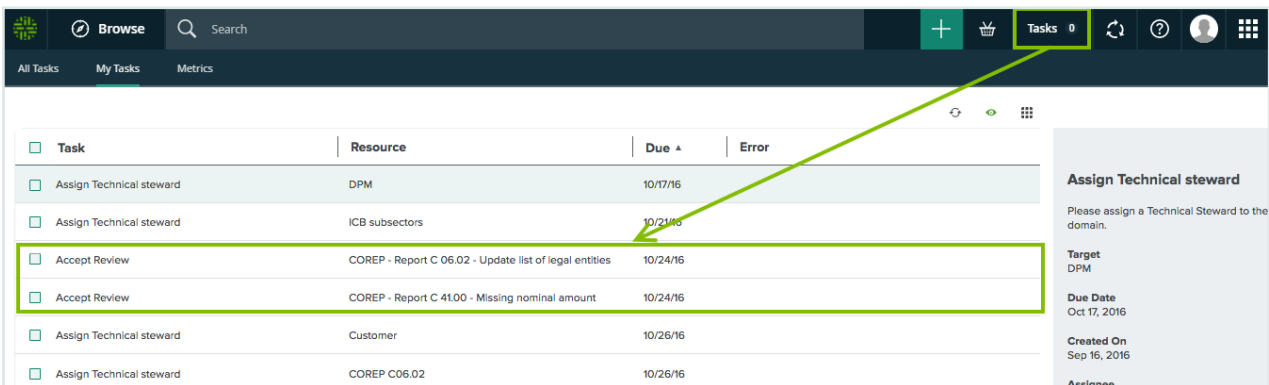

When you click the name of the task or the related resource, the issue page opens.

You can accept or reject the issue from the sidebar.

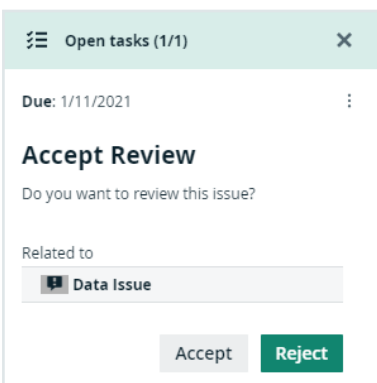

When you accept the issue, the workflow automatically advances to the next step.

Tip You can also access the issues via **Data Helpdesk** → **Issues** and apply a filter to find the issues that require an action from you.

Analyzing and proposing a solution

When the status of a task is **Under Review**, you can perform the following actions:

- **Reassign Reviewer:** Choose this action if you find that an other user is more suited to analyze the issue. The status of the task becomes **Reassign Reviewer**. Click **Submit** to assign a new user, role or group as the new reviewer for the issue.

The screenshot shows a dialog box titled "Open tasks (1/1)" with a close button (X). The dialog is for the "Reassign Reviewer" action. It includes the following fields:

- Due:** 1/11/2021
- Reassign Reviewer:** Assign a new reviewer for this issue.
- Related to:** Data Issue
- User:** Type something here and confirm using enter. ...
- Group:** Type something here and confirm using enter. ...
- Role:** Select role
- in community:** in community
- Select community:** Select community.
- Submit** button

- **More Information:** Choose this action if you need more information from the issue requester. The status of the issue becomes **Pending**. This action creates a task for the requester to provide more information about the issue. When the requester has completed this task, the workflow returns to you with a task with the same four options.
- **Invalid Issue:** Choose this action to mark the issue as invalid. The requester is notified and the issue management workflow is finished. Note that this is an irreversible action.
- **Request Approval:** Choose this action to request an approval for your analysis and solution proposal. You can only click this action when you have provided a detailed

analysis of the issue in the issue's **Analysis** attribute. In the **Resolution** attribute, you can propose a solution to the issue. When you request an approval, the contents of the **Analysis** and **Resolution** attributes can be evaluated and approved. The issue is marked as **Submitted for approval**.

Approve or reject a solution

In the approve/reject step, each stakeholder assigned to the issue is requested to accept or reject the analysis and solution proposed by the reviewer. All the stakeholders have to accept, otherwise the solution is not approved. If one stakeholder rejects the solution, the workflow creates a new task for the reviewer to update the analysis and solution, taking into account the comments given by the stakeholder who rejected the proposed solution. If approved, the issue is marked as **Accepted**.

1. In the sidebar, provide a reason for your action.
2. Click the **Approve** or **Reject** button.

1. In the task bar, click the **Approve/Reject** button.

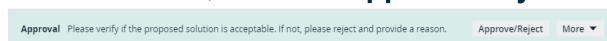

- » The **Approval** dialog box appears.

2. In the dialog box, provide a reason for your action.

3. Click the **Approve** or **Reject** button.

When all the stakeholders have approved the solution, the status of the issue becomes **Approved**.

If the last stakeholder is a reviewer, the user can immediately appoint an assignee to solve the issue or close the issue if no further action is required.

Appoint assignee or resolve the issue

When all the stakeholders have accepted the proposed solution, it does not necessarily mean that the issue is resolved. It is possible that the solution still has to be implemented.

When the solution is approved, the reviewer can decide to appoint an assignee who can implement the actual solution to resolve the issue, or mark the issue as resolved if there is no need for a specific implementation.

After appointing an assignee, the issue is marked as 'In Progress'.

You can appoint an assignee in the following ways:

- Fill in a list of users in the **User** field.
- Add groups in the **Group** field.
- Specify a role, in the **Role** field, that the selected user has to have on the current issue. If you also fill in the **in community** field, all the users with the specified role for the given community become the assignee of the issue.

Depending on the issue management workflow configuration, a user can already be proposed to you in the **User** field.

Provide a solution

In the step to provide a solution, the assignee resolves an issue and provides an implementation.

- The assignee can reassign the task to someone else if that user is more suited to perform the task. When reassigning the task, a similar form is presented as described in the earlier step where the new assignee can be appointed, see [Appoint assignee or resolve the issue](#).
- The assignee can also mark the issue as **Solved**. This ends the task and the workflow afterwards asks the reviewer to check if the solution matches the expectations. In this case, the issue is marked as **Resolution Pending**.

This task has to be completed within a predefined period, if not, the workflow returns to the previous step and presents a new task to the reviewer to appoint a new assignee to perform the task.

Instead of resolving the issue by implementing the proposed solution, it is possible that the issue can be resolved by linking it to a governance asset. For example, by forcing all

assets to comply to a business rule so that the problem described in the issue can not happen again.

To resolve an issue with a related asset, you need the correct rights in the community as assignee.

You can link the issue with a governance asset as follows:

1. On the issue page, click **Characteristic**.
2. Click the **Relations** tab.
3. Choose the **Resolved by** relation.
4. Enter the resolving governance assets in the dialog box, optionally set a **Start Date** and **End Date**.
5. Click **Save**.
6. The relation appears in the **resolved by Governance Asset** table on the issue page.
7. Click **Solved** in the green bar to mark the issue as resolved.

Review a solution

In the last step of the 'Issue Management' workflow, the reviewer can review the provided solution:

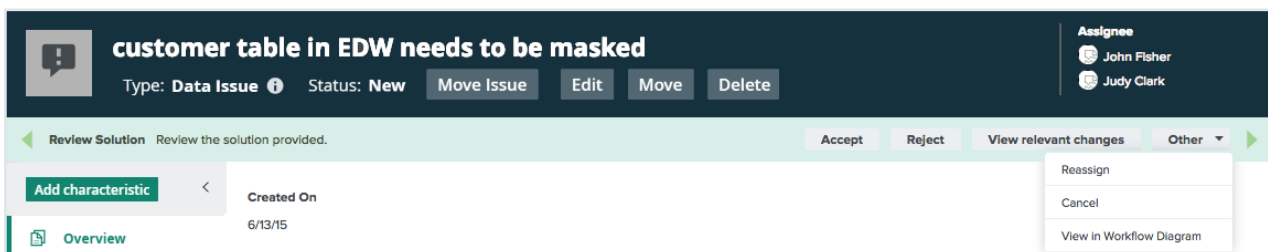

- Click **Accept** to accept the solution and mark the issue as **Resolved** and the requester is notified. This action ends the issue management workflow. If there are multiple reviewers, there is only one reviewer who has to accept the solution.
- Click **Reject** to reject the solution and mark the issue as **Under review**. The workflow returns to the Analyze and Propose Solution step, see [Analyzing and proposing a solution](#).

- Click **View relevant changes** to view the history of the issue.

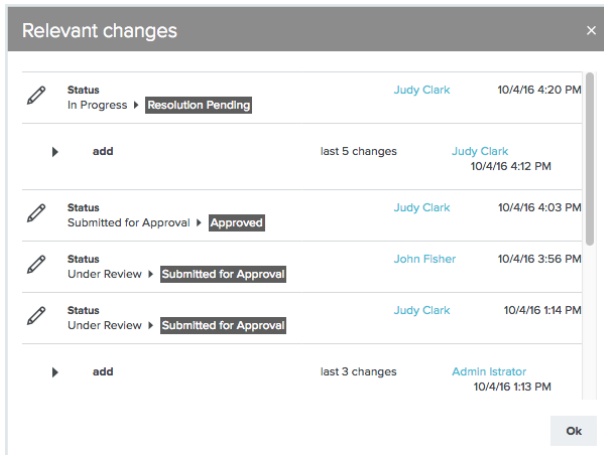

- Click **Other** → **Reassign** to assign the review step to an other user.

Metrics pages

The Metrics pages contain a variety of statistics related to how an application is used. They pages consist of one or more graphs, their legends and some counters.

For each graph, you can edit the data set and the time range shown.

Note On the **Metrics** page, the lines that are shown on a given graph are called data sets. Do not confuse these with **data sets** in the true context of CollibraData Catalog. On this page, when you click **Add data set**, it simply means that you want to add another line to the graph.

Components

The Metrics page consists of one or more graphs, their legend and some counters.

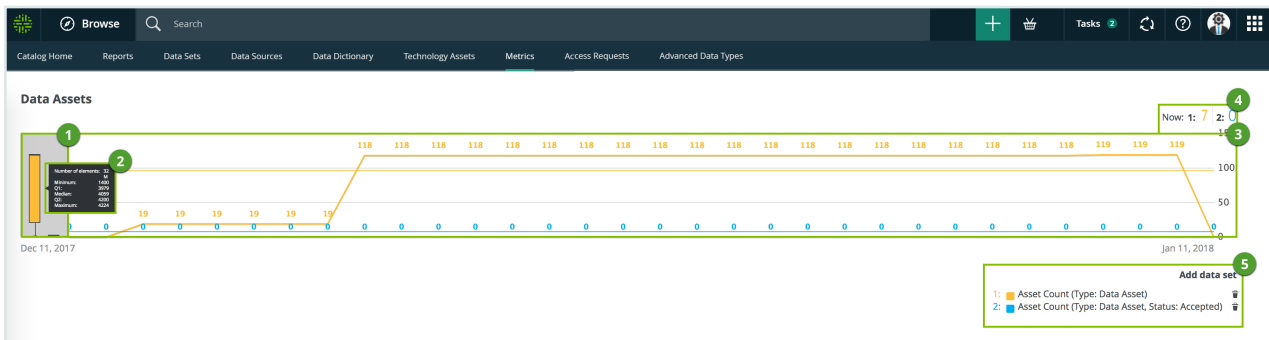

Number	Element	Description
1	Color-coded bars	<p>The color-coded bars give a quick overview of the graph.</p> <p>The vertical line leading from the color-coded bar indicates the difference between the minimum and maximum values.</p>
2	Data set details	<p>More details about the graph.</p> <p>Hover your pointer over the color-coded bars to the left of each line of graph to view them.</p>
	Number of elements	The amount of days in the time range.
	Minimum	The lowest count on any day in the data set.
	Q1	The first quartile, meaning the lowest 25% of the data set.
	Median	The median, meaning the middle value of the data set.
	Q3	The third quartile, meaning the lowest 75% of the data set.
	Maximum	The highest count on any day in the time range.
3	Graph	<p>The actual graph. What it shows exactly, depends on the data set. For example, it can show the number of assets viewed over the last month, or the number of licenses used.</p> <p>Tip You can edit the time range of the graph.</p>

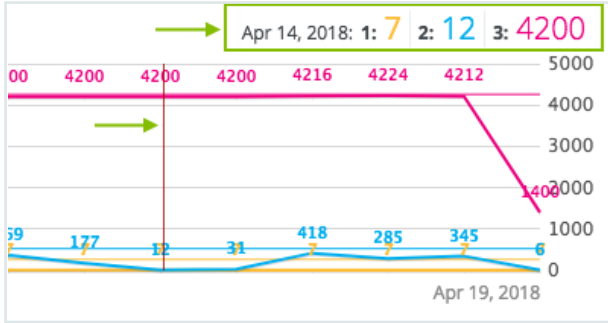
Number	Element	Description
4	Counts by day	<p>The counts for a specific day for each data set, by moving your mouse over the graph. The vertical red line identifies the day. The exact count for that day for each data set, is shown above the graph.</p> 
5	Legend	<p>The legend of the graph, which also allows you to add, edit and delete the data sets.</p>

Add a data set to a metrics graph

You can add a data set to a graph on the [Metrics pages](#), for example if you want to compare the amount of new assets of different types.

Steps

1. Open the product for which you want to see the metrics, for example Business Glossary.
2. In the submenu, click **Metrics**.
 - » The [Metrics page](#) appears.
3. Under the relevant graph, to the right, click **Add data set**.

» The filter settings appear.

4. Enter the required information:

Filter setting	Description
Filter Type	<p>The type of data that will be counted.</p> <p>Depending on the filter type that you select, different fields become available.</p>
Active Users	<p>A daily count of the active users to have viewed the relevant assets.</p> <p>You can restrict the count results via the following additional filters:</p> <ul style="list-style-type: none"> ◦ License: Limit the results to active users with a specific license type. ◦ Community: Limit the results to a specific community. ◦ Count Operation: Select the operation by which the results are shown in the template. For example, the sum of all values, the highest value or the lowest value each day over the last month. ◦ Product: Limit the results to active users within a specific Colibra Data Governance Center application. ◦ Role: Limit the results to active users that have been assigned a specific role.

Filter setting	Description
<p>Asset Count</p>	<p>A daily count of the relevant assets (either data or technology assets) that have been viewed.</p> <p>You can restrict the count results via the following additional filters:</p> <ul style="list-style-type: none"> ◦ Type: Limit the results to a specific type. ◦ Domain: Limit the results to assets from a specific domain. ◦ Count Operation: Select the operation by which the results are shown in the template. For example, the sum of all values, the highest value or the lowest value each day over the last month. ◦ Status: Limit the results to assets with a specific status. ◦ Community: Limit the results to a specific community.
<p>Changed Task Count</p>	<p>A daily count of workflow tasks that have been changed.</p> <p>You can restrict the count results via the following additional filters:</p> <ul style="list-style-type: none"> ◦ Workflow: Limit the results to a task in a specific workflow. ◦ Task Type: Limit the results to tasks of a specific type. ◦ Task: Limit the results to a specific task. ◦ Count Operation: Select the operation by which the results are shown in the template. For example, the sum of all values, the highest value or the lowest value each day over the last month. ◦ Community: Limit the results to a specific community. ◦ Task Status: Limit the results to tasks that have a specific status (Completed, Deleted or Unfinished). ◦ User: Limit the results to a specific user.

Filter setting	Description
<p>Domain Count</p>	<p>A daily count of the domains with relevant assets (either data or technology assets) that have been viewed.</p> <p>You can restrict the count results via the following additional filters:</p> <ul style="list-style-type: none"> ◦ Type: Limit the results to a specific type. ◦ Count Operation: Select the operation by which the results are shown in the template. For example, the sum of all values, the highest value or the lowest value each day over the last month. ◦ Community: Limit the results to a specific community.
<p>License Available</p>	<p>A daily count of Collibra DGC licenses that have been available to users.</p> <p>This is calculated by subtracting the licenses in use from the total licenses your organization has.</p> <p>You can restrict the count results via the following additional filters:</p> <ul style="list-style-type: none"> ◦ License: Limit the results to a specific type. ◦ Count Operation: Select the operation by which the results are shown in the template. For example, the sum of all values, the highest value or the lowest value each day over the last month.

Filter setting	Description
License Usage	<p>A daily count of Collibra DGC licenses in use by all users in your organization.</p> <p>You can restrict the count results via the following additional filters:</p> <ul style="list-style-type: none"> ◦ License: Limit the results to active users with a specific license type. ◦ Count Operation: Select the operation by which the results are shown in the template. For example, the sum of all values, the highest value or the lowest value each day over the last month.
Page Hits	<p>A daily count of Collibra DGC asset page hits.</p> <p>You can restrict the count results via the following additional filters:</p> <ul style="list-style-type: none"> ◦ Community: Limit the results to a specific community. ◦ Count Operation: Select the operation by which the results are shown in the template. For example, the sum of all values, the highest value or the lowest value each day over the last month. ◦ Domain: Limit the results to assets from a specific domain.

Filter setting	Description
Task Count	<p>A daily count of workflow tasks carried out.</p> <ul style="list-style-type: none"> ◦ Workflow: Limit the results to a task in a specific workflow. ◦ Task Type: Limit the results to tasks of a specific type. ◦ Task: Limit the results to a specific task. ◦ Count Operation: Select the operation by which the results are shown in the template. For example, the sum of all values, the highest value or the lowest value each day over the last month. ◦ Community: Limit the results to a specific community. ◦ Task Status: Limit the results to tasks that have a specific status (Completed, Deleted or Unfinished). ◦ User: Limit the results to a specific user.
Task Duration	<p>A daily count of workflow task duration.</p> <p>You can restrict the count results via the following additional filters:</p> <ul style="list-style-type: none"> ◦ Workflow: Limit the results to a task in a specific workflow. ◦ Task Type: Limit the results to tasks of a specific type. ◦ User: Limit the results to a specific user. ◦ Count Operation: Select the operation by which the results are shown in the template. For example, the sum of all values, the highest value or the lowest value each day over the last month. ◦ Community: Limit the results to a specific community. ◦ Task: Limit the results to a specific task.

5. Click **Save data set**.

Edit a data set of a metrics graph

You can edit the data set that is shown in a graph on the [Metrics](#) pages.

Steps

1. Open the product for which you want to create the asset, for example the Business Glossary.
2. In the submenu, click **Metrics**.
 - » The [Metrics page](#) appears.
3. In the legend under the relevant graph, click the data set you want to edit.

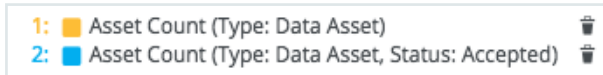

- » The filter configuration for the data set appears.
4. Enter the required information.

Filter setting	Description
Filter Type	<p>The type of data that will be counted.</p> <p>Depending on the filter type that you select, different fields become available.</p>
Active Users	<p>A daily count of the active users to have viewed the relevant assets.</p> <p>You can restrict the count results via the following additional filters:</p> <ul style="list-style-type: none"> ◦ License: Limit the results to active users with a specific license type. ◦ Community: Limit the results to a specific community. ◦ Count Operation: Select the operation by which the results are shown in the template. For example, the sum of all values, the highest value or the lowest value each day over the last month. ◦ Product: Limit the results to active users within a specific Colibra Data Governance Center application. ◦ Role: Limit the results to active users that have been assigned a specific role.

Filter setting	Description
<p>Asset Count</p>	<p>A daily count of the relevant assets (either data or technology assets) that have been viewed.</p> <p>You can restrict the count results via the following additional filters:</p> <ul style="list-style-type: none"> ◦ Type: Limit the results to a specific type. ◦ Domain: Limit the results to assets from a specific domain. ◦ Count Operation: Select the operation by which the results are shown in the template. For example, the sum of all values, the highest value or the lowest value each day over the last month. ◦ Status: Limit the results to assets with a specific status. ◦ Community: Limit the results to a specific community.
<p>Changed Task Count</p>	<p>A daily count of workflow tasks that have been changed.</p> <p>You can restrict the count results via the following additional filters:</p> <ul style="list-style-type: none"> ◦ Workflow: Limit the results to a task in a specific workflow. ◦ Task Type: Limit the results to tasks of a specific type. ◦ Task: Limit the results to a specific task. ◦ Count Operation: Select the operation by which the results are shown in the template. For example, the sum of all values, the highest value or the lowest value each day over the last month. ◦ Community: Limit the results to a specific community. ◦ Task Status: Limit the results to tasks that have a specific status (Completed, Deleted or Unfinished). ◦ User: Limit the results to a specific user.

Filter setting	Description
<p>Domain Count</p>	<p>A daily count of the domains with relevant assets (either data or technology assets) that have been viewed.</p> <p>You can restrict the count results via the following additional filters:</p> <ul style="list-style-type: none"> ◦ Type: Limit the results to a specific type. ◦ Count Operation: Select the operation by which the results are shown in the template. For example, the sum of all values, the highest value or the lowest value each day over the last month. ◦ Community: Limit the results to a specific community.
<p>License Available</p>	<p>A daily count of Collibra DGC licenses that have been available to users.</p> <p>This is calculated by subtracting the licenses in use from the total licenses your organization has.</p> <p>You can restrict the count results via the following additional filters:</p> <ul style="list-style-type: none"> ◦ License: Limit the results to a specific type. ◦ Count Operation: Select the operation by which the results are shown in the template. For example, the sum of all values, the highest value or the lowest value each day over the last month.

Filter setting	Description
License Usage	<p>A daily count of Collibra DGC licenses in use by all users in your organization.</p> <p>You can restrict the count results via the following additional filters:</p> <ul style="list-style-type: none"> ◦ License: Limit the results to active users with a specific license type. ◦ Count Operation: Select the operation by which the results are shown in the template. For example, the sum of all values, the highest value or the lowest value each day over the last month.
Page Hits	<p>A daily count of Collibra DGC asset page hits.</p> <p>You can restrict the count results via the following additional filters:</p> <ul style="list-style-type: none"> ◦ Community: Limit the results to a specific community. ◦ Count Operation: Select the operation by which the results are shown in the template. For example, the sum of all values, the highest value or the lowest value each day over the last month. ◦ Domain: Limit the results to assets from a specific domain.

Filter setting	Description
Task Count	<p>A daily count of workflow tasks carried out.</p> <ul style="list-style-type: none"> ◦ Workflow: Limit the results to a task in a specific workflow. ◦ Task Type: Limit the results to tasks of a specific type. ◦ Task: Limit the results to a specific task. ◦ Count Operation: Select the operation by which the results are shown in the template. For example, the sum of all values, the highest value or the lowest value each day over the last month. ◦ Community: Limit the results to a specific community. ◦ Task Status: Limit the results to tasks that have a specific status (Completed, Deleted or Unfinished). ◦ User: Limit the results to a specific user.
Task Duration	<p>A daily count of workflow task duration.</p> <p>You can restrict the count results via the following additional filters:</p> <ul style="list-style-type: none"> ◦ Workflow: Limit the results to a task in a specific workflow. ◦ Task Type: Limit the results to tasks of a specific type. ◦ User: Limit the results to a specific user. ◦ Count Operation: Select the operation by which the results are shown in the template. For example, the sum of all values, the highest value or the lowest value each day over the last month. ◦ Community: Limit the results to a specific community. ◦ Task: Limit the results to a specific task.

5. Click **Save data set**.

» The updated data set is shown in the graph.

Edit the time range of a metrics graph

By default, the graphs on the [Metrics pages](#) are shown in daily increments, over a time range of one month. However, you can edit the time range to suit your needs.

There are two ways to edit the time range:

- Click and drag in the graph.
- Select the dates for the graph.

Click and drag in the graph

1. Open the product for which you want to create the asset, for example the Business Glossary.
2. In the submenu, click **Metrics**.
 - » The **Metrics** page appears.
3. Optionally, **Add a data set to a metrics graph** a data set to a graph.
4. In the relevant graph, click at (or near) the first date in your desired range, and drag to the right, toward the last date in your desired range.
 - » While you are dragging, the color changes in the graph, indicating the resulting time range.

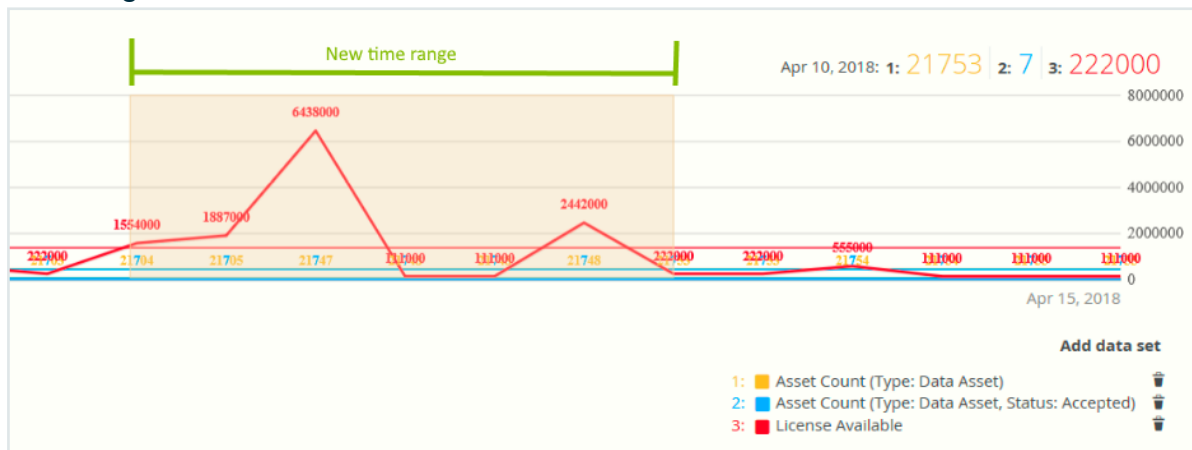

5. Release the mouse button.
 - » The graph is adjusted to the new time range.

Select the dates for the graph

1. Open the product for which you want to create the asset, for example the Business Glossary.
2. In the submenu, click **Metrics**.
 - » The [Metrics page](#) appears.
3. Optionally, [Add a data set to a metrics graph](#) a data set to a graph.
4. On the left-hand side of the graph, click the date.
 - » A date picker appears.

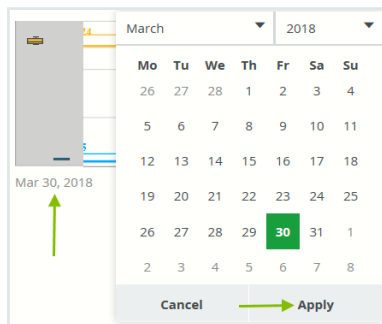

5. Click the first day of your desired time range, and then click **Apply**.
 - » The graph is adjusted to the date you selected.
6. On the right-hand side of the graph, click on the date.
 - » A date picker appears.
7. Click the last day of your desired time range, and then click **Apply**.
 - » The graph is adjusted to the date you selected.

Remove a data set from a metrics graph

You can remove a data set that is shown in a graph on the [Metrics pages](#) if you don't want to see, for example, if you think there is too much information in a graph.

Note Each graph will always show at least one data set. If it only contains one data set and you want to remove it, you first have to [Add a data set to a metrics graph](#) another data set. You can then remove the other one.

Steps

1. Open the product for which you want to create the asset, for example the Business Glossary.
2. In the submenu, click **Metrics**.
 - » The [Metrics page](#) appears.
3. In the legend under the relevant graph, click on  next to the data set you want to delete.

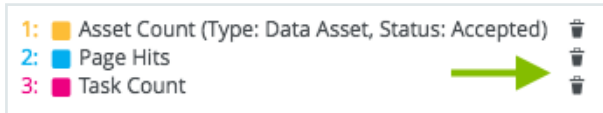

- » The graph is updated.

Data Stewardship

The Collibra Data Stewardship application helps data stewards manage their daily tasks. It also helps the administrators manage their stewards.

Stewards can monitor and maintain their own space in the company's data governance ecosystem. This gives them a clear picture of their responsibilities inside the data governance structure.

The screenshot shows the 'Roles and responsibilities' view in the Collibra Data Stewardship application. The interface includes a top navigation bar with 'Browse', 'Search', and 'Tasks' (0). Below the navigation bar, there are tabs for 'Organization', 'Business Dimensions', 'Tags', 'Physical Data Connector', 'Metrics', and 'Data Classification'. The main content area displays a table with the following columns: Name, Description, Domain Type, Owner, Stakeholder, and Business Steward.

Name	Description	Domain Type	Owner	Stakeholder	Business Steward
Business Analysts Commun...				DataLake Admin	Eliza Arquette
Schemas	Community containing all inge...				
amort_exp		Physical Data Dictionary	DataLake Admin	Cliff Baker	John Fisher
BRIDGE		Physical Data Dictionary	DataLake Admin	Cliff Baker	John Fisher
CRM Cloud Consum...		Physical Data Dictionary	Joanna Zhou	Cliff Baker	William Parker
CRM Cloud Raw Data		Physical Data Dictionary	Joanna Zhou	Cliff Baker	Preston Sterling

Data Stewardship submenu pages

Page	Description
Organization	Contains a view with the hierarchical overview of communities and domains.
Business Dimensions	Contains views for Business Process assets, Data Category assets and Line of Business assets.
Tags	Provides an overview of all tags in Collibra Data Governance Center.

Page	Description
Physical Data Connector	Contains a table with high-level database information.
Metrics	Contains a variety of statistics related to how the assets of the Stewardship application are used.
Data Classification	Shows the available data classes in your Colibra DGC environment.

Using workflows

Workflows in Collibra Data Governance Center allow you to define process steps, in BPMN standards, to get work done from initiation until completion, while at the same time defining ownership of every individual step. They allow users to complete tasks in a strictly guided and controlled way.

Start a global workflow	770
Start an asset workflow from an asset page	770
Start an asset workflow from an asset table or set of tiles	770
My Tasks page	771
Viewing workflow tasks	773
Working with tasks	774

Start a global workflow

If you want to start a workflow that is not linked to an asset, follow these steps:

1. Go to a dashboard.
 - If the dashboard does not have the workflow widget and you have the right permissions, you can add it yourself, see [Add a widget to a dashboard](#).
 - If you are not logged in and the guest user access is enabled for the workflow, you have to provide some identification and click **Continue**.
2. In the workflow widget, click on the button of the workflow that you want to start.
3. Fill in the required information in the dialog box and click the button at the bottom to confirm.

Note The button's label depends on the workflow, for example, "Propose" for the Propose Business Term workflow or "Create" for the New Data Set workflow.

Start an asset workflow from an asset page

If you are on an asset page and you want to start a workflow for that asset, follow these steps:

1. In the title bar, click the workflow that you want to start.

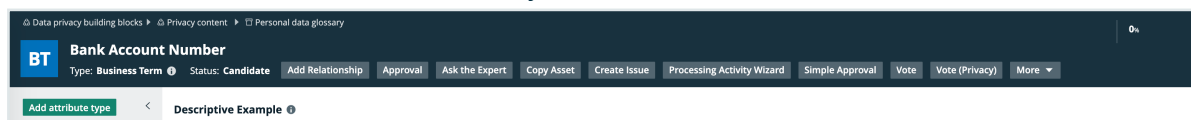

2. If necessary, fill in the form.
3. Click **Submit** at the bottom, to confirm.

If you do not see the **Submit** button, you have to scroll to the bottom in the dialog box.

Start an asset workflow from an asset table or set of tiles

You can start a workflow for one or more specific assets.

Steps

1. Navigate to a table or set of tiles.
2. If you are:
 - in table **display mode**, select the check boxes in front of the assets for which you want to start a workflow.
 - in tile display mode, select the tiles for which you want to start a workflow. More information: [Select multiple tiles](#).
3. In the menu above the selected assets, click the name of the workflow you want to start.
Only workflows that can be started for all selected assets at once are available.
If necessary, fill in the form that is displayed.
4. Click **Submit**.

Tip On the [search page](#), you can also start an asset workflow by clicking  for the relevant asset.

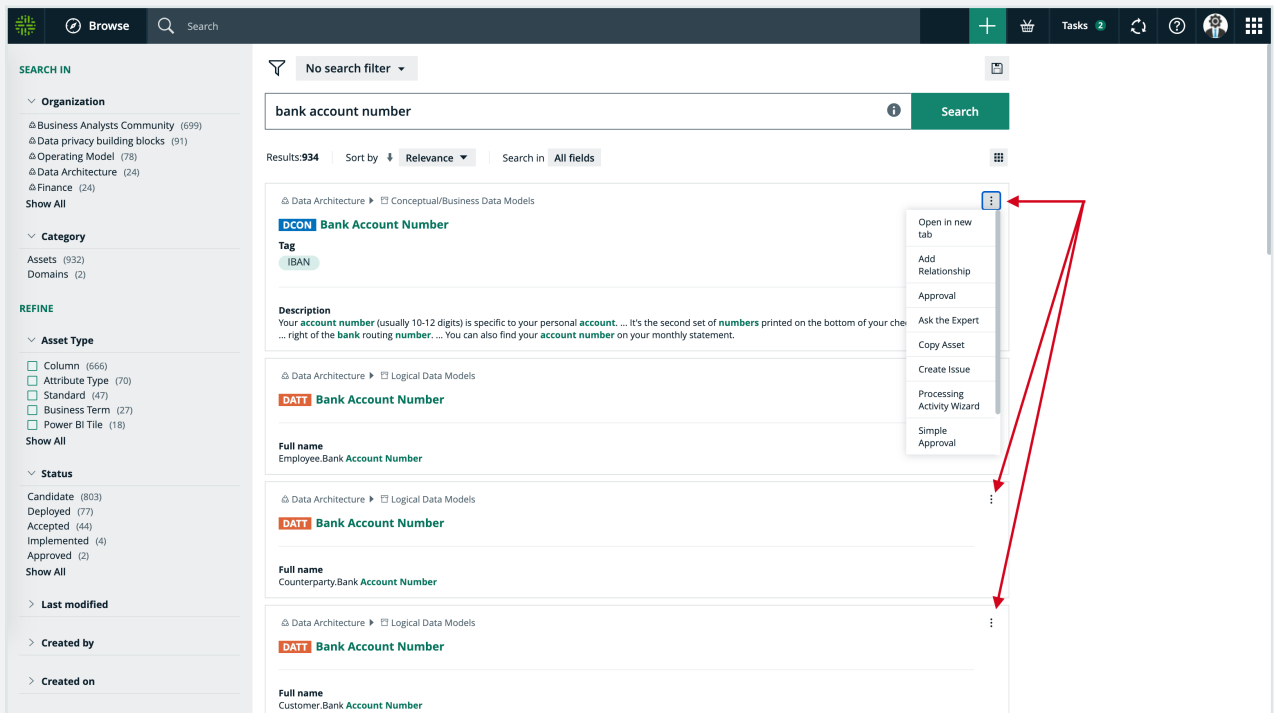

The screenshot shows a search results page for 'Bank Account Number'. The page has a dark header with 'Browse' and 'Search' buttons. Below the header, there's a search filter section with 'No search filter' and a search bar containing 'bank account number'. The results are sorted by 'Relevance' and show 934 results. The first result is 'OCOM Bank Account Number' with a tag 'IBAN'. Below it are three 'DATT Bank Account Number' results. A context menu is open over the first 'DATT Bank Account Number' result, showing options like 'Open in new tab', 'Add Relationship', 'Approval', 'Ask the Expert', 'Copy Asset', 'Create Issue', 'Processing Activity Wizard', 'Simple', and 'Approval'. Red arrows point from the tip text to the three dots menu icon and the context menu options.

My Tasks page

The following image shows the different parts of the **Tasks** page:

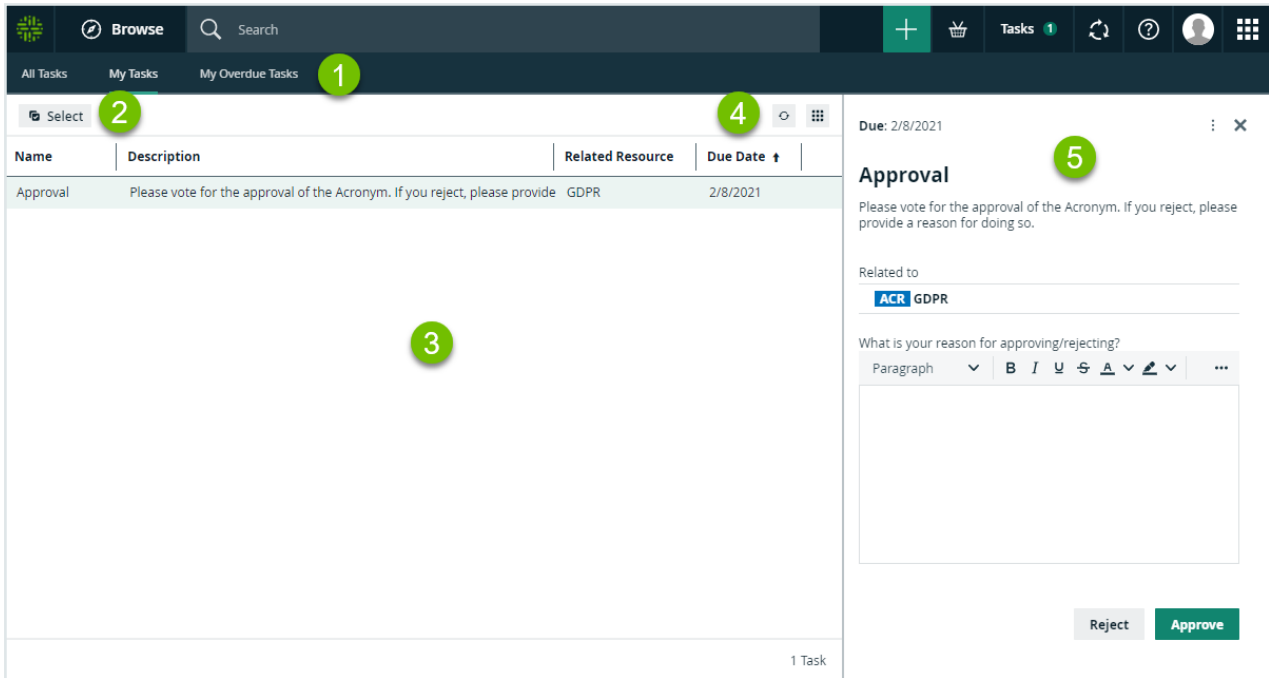

Element	Name	Description
1	Tasks submenu	Contains the following pages: <ul style="list-style-type: none"> • All Tasks: Shows all the tasks for which you have permission to view. • My Tasks: Shows all the tasks that have been assigned to you. • My Overdue Tasks: Shows the tasks that have been assigned to you that are past their due date.
2	Select button	Allows you to select one or multiple tasks for bulk operations.
3	Tasks table	Shows a list of tasks.
4	Table menu	Contains refresh and display options for tasks table.
5	Sidebar	Contains all the elements that allow you to complete the task.

Viewing workflow tasks

Workflows create tasks that ask users to provide input or to perform certain actions. You can view the tasks that are currently assigned to you in different locations, in different contexts.

If a task is part of a workflow that has been started for a specific resource, you can consult the task on the resource page.

It is displayed in the sidebar:

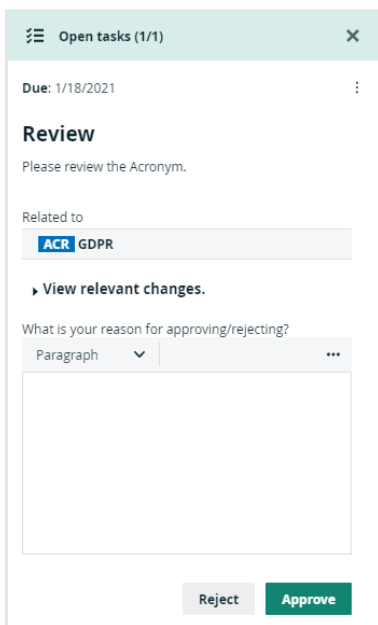

You can also view all the tasks that have been assigned to you per resource. On the main menu bar, click the **Tasks** button.



A page with a list of your tasks is displayed by default. You can order the tasks alphabetically by clicking the column headers.

With the correct permission, you can do the following:

- Consult all other open tasks, on the **All Tasks** page. This view shows all your tasks and tasks for other users, for which you have permission to view.
- Cancel or reassign the tasks on the **All Tasks** page. When you cancel a task, you have to provide a reason in the dialog box that is displayed. After you have

confirmed, the reason is shown as a comment on the corresponding asset page. You must not, in any way, complete tasks of other users.

An **Error** column displays an error message if the workflow task encountered an unexpected error.

Working with tasks

Each task asks you to perform some kind of action. This can be something external to the application, provide input or change something in the application directly. When a task requires input, you are presented with a form to fill in the required information. You can complete tasks on the asset page or on the tasks pages.

If you have more than one consecutive task assigned to you, each subsequent task is displayed immediately after the previous one is completed. This is especially useful in situations where a workflow is designed with multiple forms, one after the other, or a when you have more than one role for a resource.

An example of this behavior is shown in the asset page screenshots in this section, where the user is assigned to Subject Matter Expert, Stakeholder, and Steward.

For an example of a complete workflow, see [Tasks in the Issue Management workflow](#).

Completing a task on the asset page

On asset pages, all task-related data is shown in the sidebar. You can complete all tasks actions from the sidebar.

The screenshot displays the Data Governance Council interface. At the top, the breadcrumb path is 'Data Governance Council > New Business Terms'. The user is identified as 'Business Steward Admin Istrator'. The main content area shows an 'ACR GDPR' asset with a status of 'Candidate'. A sidebar on the left lists various options: Overview, Tags, Comments, Diagram, Pictures, Responsibilities, References, History, and Files. The 'Overview' section is active, showing 'Descriptive Example' with a note: 'No value has been given yet. Double click or use the edit button.' Below this are sections for 'Tags', 'Comments', and 'Related to'. The 'Approval' task is highlighted with a green border. It shows a due date of '2/8/2021' and asks the user to 'Please vote for the approval of the Acronym. If you reject, please provide a reason for doing so.' The task is related to 'ACR GDPR' and includes a rich text editor for providing a reason. At the bottom of the task panel are 'Reject' and 'Approve' buttons.

If the sidebar is not open, a task button indicates the number of active tasks.

This screenshot shows the same interface as above, but with the sidebar closed. In the top right corner of the main content area, there is a task button (represented by a list icon) with a green arrow pointing to it from the right. This button indicates the number of active tasks.

Completing a task from My Tasks page

On the **My Tasks** page, all your tasks are listed in a table.

To complete tasks from here you can use one of the following options:

- In the preview panel on the right of a selected task, you get information about the task and the step in the workflow diagram. Click on one of the buttons to complete the task.

Review

Please review the Business Term.

Target
Account Passwords

Due Date
Dec 18, 2020

Created on
Nov 18, 2020

Assignee
DataLake Admin

More ▾ Reassign Cancel

- When you select a check box in front of a task, the actions that are possible for that task are displayed above the table. Click on one of the buttons to complete the task.

Task	Resource	Due +	Error	Assignee
<input type="checkbox"/> Review	Account Passwords	12/18/2020		DataLake Admin
<input type="checkbox"/> Review	Attrition Rate	12/18/2020		Eliza Arquette
<input type="checkbox"/> Approval	Attrition Rate	12/18/2020		John Fisher
<input checked="" type="checkbox"/> Approval	Background Check Information	12/18/2020		OTG AM
<input checked="" type="checkbox"/> Approval	Background Check Information	12/18/2020		DataLake Admin
<input checked="" type="checkbox"/> Approval	Background Check Information	12/18/2020		Admin151980r

- When you select the check boxes of multiple tasks, the actions that are possible for that task are also displayed above the table. Click on one of the buttons to complete multiple tasks at once.

Task	Resource	Due +	Error	Assignee
<input checked="" type="checkbox"/> Review	Account Passwords	12/18/2020		DataLake Admin
<input type="checkbox"/> Review	Attrition Rate	12/18/2020		Eliza Arquette
<input type="checkbox"/> Approval	Attrition Rate	12/18/2020		John Fisher
<input checked="" type="checkbox"/> Approval	Background Check Information	12/18/2020		OTG AM
<input checked="" type="checkbox"/> Approval	Background Check Information	12/18/2020		DataLake Admin
<input type="checkbox"/> Approval	Background Check Information	12/18/2020		Admin151980r

- If there is a form to fill in, it contains the names of all the assets for which you are completing a task.

Even when you select different types of tasks, all the different options to complete a task are displayed. However, only the tasks for which the action is possible are completed and you cannot complete all of the tasks at once.

Cancel a task

With the correct permissions, you can cancel a task.

1. In the main menu, click **Tasks**.
2. Click in the row of task that you want to cancel. Do not click the task name or resource name as that will open respectively the task details or asset page.
 - » The row is highlighted and the preview pane on the right is updated.
3. At the bottom of the preview pane, click **Cancel**.
4. Fill in an optional reason to cancel the task and click **Cancel Task**.

Note Canceling a task means that the entire workflow is canceled and an event is created. It is possible that other workflows are listening for this event and are started automatically when this event occurs.

Reassign a task

With the correct permissions, you can reassign a task. To do so, follow these steps:

1. In the main menu, click **Tasks**.
2. Click in the row of task that you want to cancel. Do not click the task name or resource name as that will open respectively the task details or asset page.
 - » The row is highlighted and the preview pane on the right is updated.
3. At the bottom of the preview pane, click **Reassign**.
4. Fill in the **Reassign task** dialog box.
 - » The workflow continues with the new set of users as candidates for the task. Keep in mind that if the task expects, for example, an attribute to be changed by one of the newly assigned users, that user needs the permission to do so.
5. Click **Reassign**.

View a workflow diagram

Each task is part of a workflow. With the correct permissions, you can open the full workflow diagram. This allows you to see in which stage of the workflow the task is located.

1. In the main menu, click **Tasks**.
2. Click the row of task that you want to cancel. Do not click the task name or resource name as that will open respectively the task details or asset page.
 - » The row is highlighted and the sidebar displays the task.
3. In the sidebar, click the ellipses **⋮** → **View in workflow diagram**.
 - » A rendering of the current position of the task in the workflow is displayed.

Collibra DGC settings

The settings of Collibra Data Governance Center allow you to customize the operating model of your environment to your needs.

By default, the settings open on a landing page that allows you to navigate to each of the sections. Contact [Collibra support](#) if you want to enable or disable this Settings landing page.

Settings

- General**
 - System | Activities | Language
- Operating model**

The operating model describes the structure of the instance data in your environment. For example, asset types and domain types.

 - Asset types | Domain types | Attributes | Relations | Complex relations | Statuses | Data quality rules | Scopes
- Roles and permissions**

Permissions determine which users can access which products and the actions they can do on resources. Users are granted permissions via roles and responsibilities.

 - Global roles | Resource roles | Global Permissions | Resource Permission
- Workflows**

Workflows define processes and manage their execution. They coordinate tasks that are done automatically, or by users. This allows you to streamline business processes and make collaborative decisions in a guided and controlled way.

 - Definitions | Instances
- Users and groups**

User accounts grant people secure access to Collibra Platform. User groups facilitate sharing permissions and responsibilities across groups of users.

 - Users | Groups
- Migration**

Migration allows an Administrator to export parts of the Operating Model from one Collibra instance, and import it into another Collibra instance, while retaining the resource IDs

 - Export | Import

General settings page

On the **General** settings page of the [Collibra DGC settings](#), you can view and edit general settings. For example, you can see technical information and all [activities](#). You can also add additional [interface languages](#) and manage [banners](#).

Tab pages



The **General** settings page of the Collibra DGC settings is split in several tab pages:

Tab page	Description
System	This tab page contains information about the installation of your Collibra DGC environment. You can also do the following: <ul style="list-style-type: none"> • Rebuild the search index. • Rebuild automatic hyperlinks. • Upgrade the activity history.
Activities	This tab page contains a table with activities . You can also see this information, in a more compact form, if you click on the menu bar.
Language	This tab page allows you to edit or translate the interface text of Collibra DGC.
Banners	This tab page allows you to create, edit or delete banners .

Rebuild hyperlinks

Collibra Data Governance Center can automatically create hyperlinks between assets. However, if those hyperlinks are outdated, you can rebuild them.

Steps

1. In the main menu, click , then  **Settings**.
 - » The [Collibra DGC settings page](#) opens.
2. Click **General**.

- » The [general settings](#) appear on the **Activities** tab page.
- 3. In the **Automatic Hyperlinks** section, click **Rebuild automatic hyperlinks**.



Upgrade the activity history after an upgrade to 2020.11/5.7.7

After an upgrade to 2020.11/5.7.7, the activity history of assets is not automatically visible in Collibra Data Governance Center. To view the activity history, you have to upgrade the history.

Note

- The backup you restore needs to contain history data. This is one of the options when [creating](#) a backup.
- This is a one-time only action, subsequent upgrades don't require this extra step.

Steps

1. In the main menu, click , then  **Settings**.
 - » The [Collibra DGC settings page](#) opens.
2. Click **General**.
 - » The [general settings](#) appear on the **Activities** tab page.
3. At the bottom of the page, click **Upgrade History**.

What's next?

The history in the backup is converted to the new environment. The conversion time depends on the size of the history in the backup.

You can see the status of the history upgrade by [viewing](#) your activities.

Interface text languages

The interface text of Collibra Data Governance Center is available in several languages. The default language is English, but you can download French, German and Spanish

translations from the [Downloads section of the Collibra Product Resource Center](#).

You can [choose](#) the interface language in your profile page. As an administrator, you can also [edit and translate](#) the interface text.

Limitations

Most of the text in the interface of Collibra DGC is translatable, including buttons, messages, tooltips, dialog boxes. However, there are some important limitations:

- The supported languages of Collibra DGC are the following:
 - English
 - French
 - German
 - Spanish

Important Collibra DGC does not support other languages for the interface text and your instance data. For example, there are known issues with sorting and filtering non-Latin characters, and the Search feature might not return the right search results.

- The operating model is not translatable:
 - Asset types
 - Domain types
 - Statuses
 - Characteristic types
 - Roles
 - Scopes
- Instance data is not translatable:
 - Asset names
 - Characteristics
 - Tags and comments
 - Names of views and filters
 - Text in dashboards and widgets

Structure of the interface text

The interface text is divided in translation messages, which consist of the following elements:

Element	Description
Message key	<p>The message key is a unique identifier that Collibra DGC uses to retrieve the correct interface text.</p> <p>Example <code>Activities.ActivitiesTable.status.error</code> = Error</p>
Equal sign	<p>An equal sign between spaces (=).</p> <p>Example <code>TextEditor.edit</code> = Edit</p>
A piece of interface text	<p>The interface text is the actual piece of text in the user interface.</p> <p>Example <code>COMMENT_ADDED</code> = Comment Added</p>
Variables (optional)	<p>Interface text may contains variables, which are placeholders for a piece of information. They are filled in when the text appears on the screen. They are represented by a number between curly brackets (<code>{0}</code>).</p> <p>Example <code>PASSWORD_TOO_SHORT</code> = The password must be at least <code>{0}</code> characters long.</p>
Markup (optional)	<p>Interface text may contain HTML tags to format text or to create hyperlinks in a piece of interface text.</p> <p>Example <code>core.header.expired</code> = Your password has expired!
Please change your password here.</p>

Edit or translate interface text

You can edit or translate the **interface text** of the Collibra Data Governance Center to meet your company's needs.

You can work in the editor of Collibra DGC, or you can copy the translation messages to a text file. You can then send the file to qualified translators, who may not have the required permissions to work in Collibra DGC.



Tip You can download files containing the translation of the Collibra DGC interface into French, German and Spanish from the [Downloads page](#) of the Collibra website.

Note Message keys are not always backwards compatible with other Collibra DGC versions. When you upgrade to a newer version, there might be new keys, renamed keys or keys that have been deleted.

Prerequisites

- You have a [global role](#) that has the System administration [global permission](#).

Steps

1. In the main menu, click , then  **Settings**.
 - » The [Collibra DGC settings page](#) opens.
2. Click **General**.
 - » The [general settings](#) appear on the **Activities** tab page.
3. In the tab pane, click **General** → **Language**.

- At the top of the editor, choose the interface language.

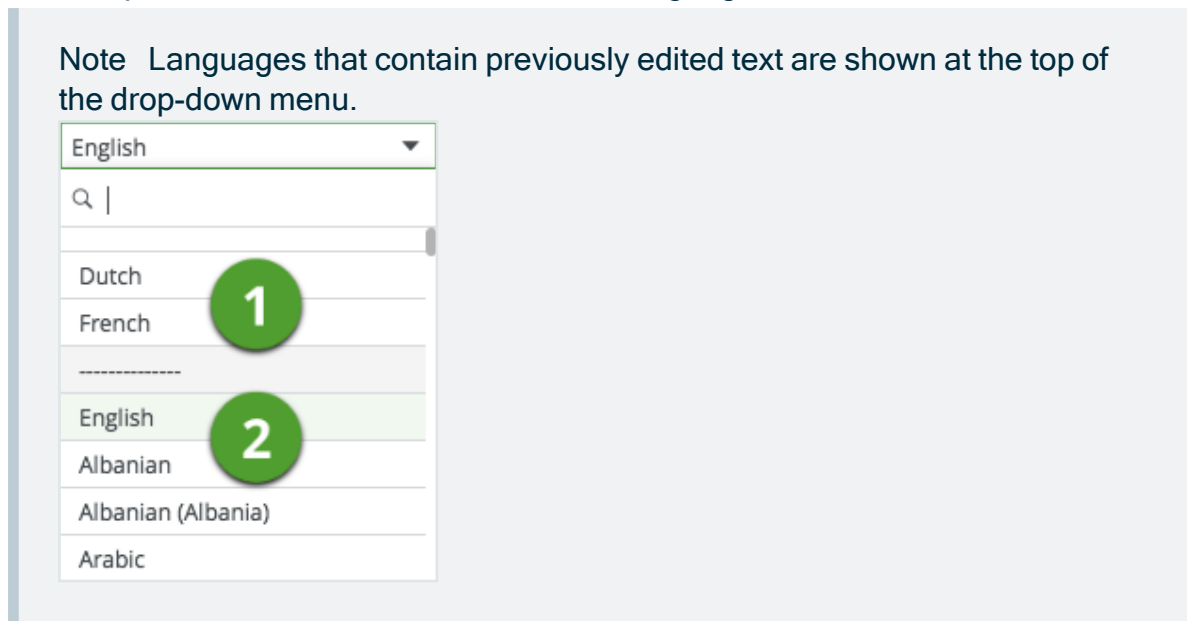

- » If you chose a previously edited language (1), the editor contains the list of translation messages.
 - » If you chose a new language (2), click **Load Defaults** to fill the editor with the default English UI text.
- Edit or translate the interface text, or paste the content from your translation file.
 - Click **Save**.

What's next?

You can [choose](#) the interface language in your account settings.

Banners

Banners are messages that are visible for all users, on all pages of Collibra Data Governance Center.

If you have a [global role](#) with the System Administration [global permission](#), you can [create](#), [edit](#) and [delete](#) banners in the **Banners** page of the **General** section of the [Collibra DGC settings](#).

Top Banner

The top banner appears at the top of the page. It can contain up to 500 characters of rich text, including line breaks, but no images. You can dismiss it, after which it no longer appears until the message is updated. This is typically a good place to make company-wide announcements.

Bottom Banner

The bottom banner appears at the bottom of the page. It can contain up to 250 characters of rich text, but no line breaks or images. You cannot dismiss the bottom banner and it is always visible, even in printed output. We recommend that you only use the bottom banner to display important information, such as disclaimers and legal information.

Example

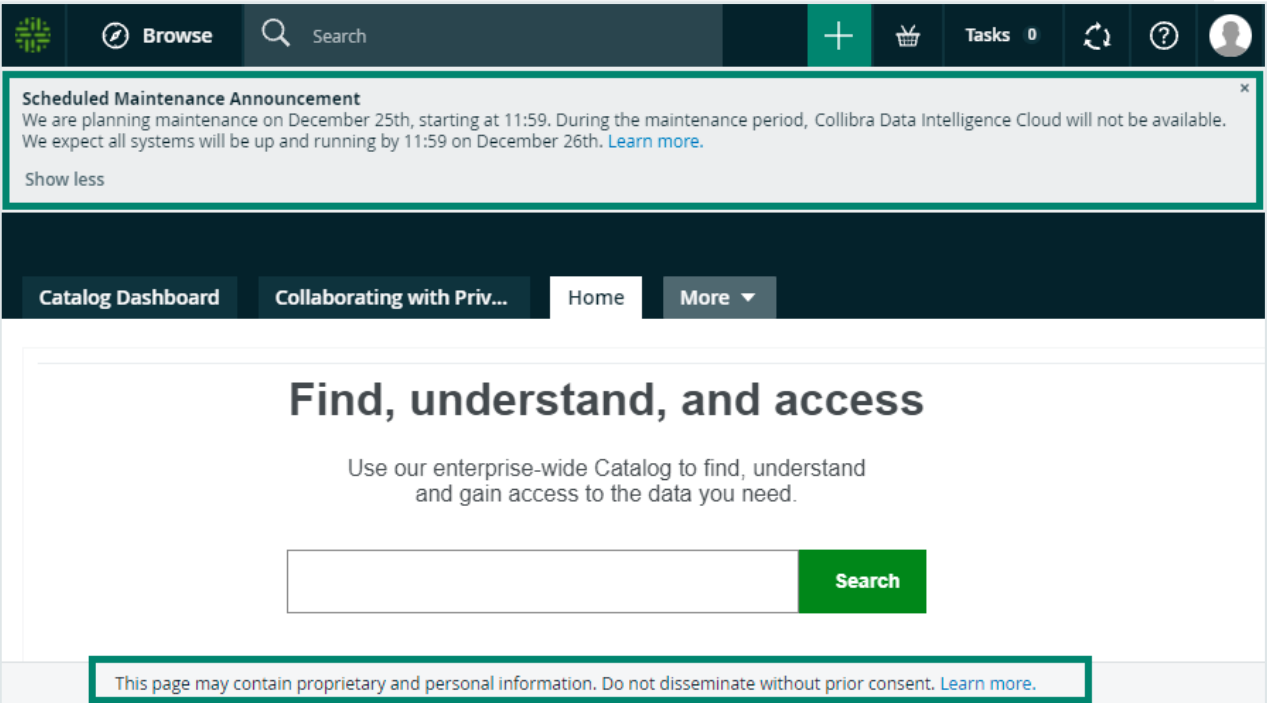

The screenshot displays a web application interface. At the top, there is a dark navigation bar with a 'Browse' button, a search input field, and several utility icons including a plus sign, a shopping cart, 'Tasks 0', a refresh icon, a help icon, and a user profile icon. Below the navigation bar is a 'Scheduled Maintenance Announcement' banner with a close button (x) in the top right corner. The announcement text reads: 'We are planning maintenance on December 25th, starting at 11:59. During the maintenance period, Collibra Data Intelligence Cloud will not be available. We expect all systems will be up and running by 11:59 on December 26th. [Learn more.](#)' and includes a 'Show less' link. Below the announcement is a dark navigation bar with menu items: 'Catalog Dashboard', 'Collaborating with Priv...', 'Home', and 'More' with a dropdown arrow. The main content area features a large heading 'Find, understand, and access', followed by the text 'Use our enterprise-wide Catalog to find, understand and gain access to the data you need.' Below this is a search input field and a green 'Search' button. At the bottom of the page, there is a bottom banner with the text: 'This page may contain proprietary and personal information. Do not disseminate without prior consent. [Learn more.](#)'

Create a banner



You can create a [banner](#) to post messages to all Collibra DGC users.

Tip You can dismiss the top banner, so use it to post temporary announcements. You cannot dismiss the bottom banner, so use it to post important information, such as disclaimers and legal information.

Prerequisites

You have a [global role](#) that has the System administration [global permission](#).

Steps

1. Open the **Banners** page of the **General** section of the Collibra DGC settings:
 - a. In the main menu, click , then  **Settings**.
 - » The [Collibra DGC settings page](#) opens.
 - b. In the **General** section, click **Banners**.
 - » The **Banners** page opens.
2. In the **Top Banner** or **Bottom Banner** section, double-click or click .
3. Enter the content of the banner.
4. Click **Publish**.
 - » The **Publish Banner** dialog box appears.
5. Click **Publish**.
 - » The banner is now visible on all pages for all users.



Edit a banner

You can edit a [banner](#) to update the message to all Collibra DGC users.

Prerequisites

You have a [global role](#) that has the System administration [global permission](#).

Steps

1. Open the **Banners** page of the **General** section of the Collibra DGC settings:
 - a. In the main menu, click , then  **Settings**.
 - » The [Collibra DGC settings page](#) opens.

- b. In the **General** section, click **Banners**.
 - » The **Banners** page opens.
2. In the **Top Banner** or **Bottom Banner** section, double-click or click .
3. Edit the content of the banner.
4. Click **Publish**.
 - » The **Publish Banner** dialog box appears.
5. Click **Publish**.
 - » The updated banner appears on all pages for all users.



Delete a banner

You can delete a [banner](#) if it's no longer needed.

Prerequisites

You have a [global role](#) that has the System administration [global permission](#).

Steps

1. Open the **Banners** page of the **General** section of the Collibra DGC settings:
 - a. In the main menu, click , then  **Settings**.
 - » The [Collibra DGC settings page](#) opens.
 - b. In the **General** section, click **Banners**.
 - » The **Banners** page opens.
2. In the **Top Banner** or **Bottom Banner** section, double-click or click .
- » The **Remove Banner** dialog box appears.
3. Click **Remove**.
 - » The banner is no longer visible on any page.

Operating model settings page

On the **Operating model** settings page of the [Collibra DGC settings](#), you can view and edit the operating model, which defines the structure of the instance data, for example [asset types](#), [domain types](#), [characteristic types](#) and [statuses](#).

Tab pages

The **Operating model** settings page of the Collibra DGC settings is split in several tab pages:

Tab page	What you can do
Asset types	View and edit asset types and their assignments .
Domain types	View and edit domain types
Characteristics	View and edit characteristic types .
Attributes	View and edit attribute types .
Relations	View and edit relation types .
Complex relations	View and edit complex relation types .
Statuses	View and edit statuses .
Data quality rules	View and edit data quality rules .
Scopes	View and edit scopes .

Roles and permissions settings page

On the **Roles and permissions** settings page of the [Collibra DGC settings](#), you can view and edit the [permissions](#) and [roles](#) to define which actions users can do.

Tab pages

The **Roles and permissions** settings page of the Collibra DGC settings is split in several tab pages:

Tab page	Description
Global roles	This tab page allows you to view and edit global roles , and add or remove users.
Resource roles	This tab page allows you to view and edit resource roles , and add or remove users.
Global per- missions	This tab page allows you to view global permissions , and add or remove global permissions to or from global roles.
Resource per- missions	This tab page allows you to view resource permissions , and add or remove resource permissions to or from resource roles.

Permissions

A permission is an authorization to access an application of Collibra Data Governance Center, or to view or edit a resource.

Users are not granted permissions directly, but through [global roles](#) and [responsibilities](#).

Collibra DGC provides a set of permissions that are included in the default roles.

Permission types

Collibra DGC has two types of permissions:

- [Global permissions](#)
- [Resource permissions](#)

Required license type of permissions

Collibra DGC has several types of permissions, based on the [license type](#) that a user needs to act on the permission.

Resource per- mission type	Description
Consumer permission	A consumer permission is a permission for which a consumer license or higher is required.
Author permission	An author permission is a permission for which an author license is required.

Actions

- Determine which [global permissions](#) are included in [global roles](#).
- Determine which [resource permissions](#) are included in [resource roles](#).

Global permissions

A global permission is a [permission](#) that applies across all Collibra DGC applications. It can be [added](#) to a [global role](#).

For an overview of the permissions in each packaged global role, see the online version of this documentation.

Global permission	Description	Required license
Asset grid	The Asset grid global permission contains global permissions that allow users to configure asset grids.	
Administration	<p>The Asset grid > Administration global permission allows users to create and manage asset grids.</p> <div style="border: 1px solid #ccc; padding: 5px; margin-top: 10px;"> <p>Note This global permission is only visible if Asset Grid Permission is enabled in Collibra Console.</p> </div>	Consumer
Catalog	The Catalog global permission contains global permissions that allow users to use advanced features of Data Catalog.	
Advanced Data Type	The Catalog > Advanced Data Type permission group contains global permissions that allow users to manage advanced data types.	

Global permission	Description	Required license
Add	The Catalog > Advanced Data Type > Add global permission allows users to create advanced data types.	Author
Remove	The Catalog > Advanced Data Type > Remove global permission allows users to delete advanced data types.	Author
Update	The Catalog > Advanced Data Type > Update global permission allows users to edit advanced data types.	Author
Register Profiling Information	The Catalog > Register Profiling Information global permission allows API users to enable data profiling when registering a data source.	Author
Technical Lineage	The Catalog > Technical Lineage global permission allows users to see the technical lineage of a data source.	Consumer
Edge	<p>The Edge global permission contains global permissions that allow users to install and manage Edge sites.</p> <div style="border: 1px solid #ccc; padding: 5px; margin-top: 10px;"> <p>Note Currently, Edge is an on-demand cloud service. It will only become the default service once the migration from Jobserver to Edge is complete.</p> </div>	
Insights	The Insights global permission groups contains global permissions related to Insights.	

Global permission	Description	Required license
Download the Insights reporting data	The Insights > Download the Insights reporting data global permission allows users to download the data from Insights.	Author
View Insights reports	The Insights > View Insights reports global permission allows users to open and see Insights reports.	Consumer
Product Rights	The Product Rights permission group contains global permissions that allow users to access Collibra applications.	
Assessments	The Product Rights > Assessments global permission allows users to access the Assessments application.	Consumer
Business Semantics Glossary	The Product Rights > Business Semantics Glossary global permission allows users to access the Business Glossary application.	Consumer
Catalog	The Product Rights > Catalog global permission allows users to access the Data Catalog application.	Consumer
Data Dictionary	The Product Rights > Data Dictionary global permission allows users to access the Data Dictionary application.	Consumer
Data Helpdesk	The Product Rights > Data Helpdesk global permission allows users to access the Data Helpdesk application.	Consumer

Global permission	Description	Required license
Data Stewardship Manager	The Product Rights > Data Stewardship Manager global permission allows users to access the Data Stewardship application.	Consumer
Policy Manager	The Product Rights > Policy Manager global permission allows users to access the Policy Manager application.	Consumer
Reference Data Manager	The Product Rights > Reference Data Manager global permission allows users to access the Reference Data application.	Consumer
System Administration	The Product Rights > System Administration global permission allows users to manage all sections of the Collibra DGC Settings, including the general settings, the operating model , roles, permissions, users, groups and workflows.	Author
User Administration	The Product Rights > User Administration global permission allows users to manage users and groups.	Author
Workflow Administration	The Product Rights > Workflow Administration global permission allows users to access the Workflow tab page of the Collibra DGC Settings.	Author
Resources	The Resources permission group contains global permissions that allow users to see and manage assets, domains and communities.	

Global permission	Description	Required license
Manage all resources	The Resources > Manage all resources global permission allows users to see and manage all assets, domains and communities regardless of responsibilities .	Author
Tags	The Tags permission group contains global permissions that allow users to see and manage tags in the Data Stewardship application.	
Manage tags	The Tags > Manage tags global permission allows users to edit and delete tags on the tags page in the Data Stewardship application.	Author
View tags	The Tags > View tags global permission allows users to see the Tags Overview page in the Data Stewardship application.	Consumer
View Permissions	The View Permissions permission group contains global permissions that allow users to see all views, which includes dashboards, diagram views, asset views, search filters and relation views on an asset page.	
View All	The View Permissions > View All global permission allows users to see all views, which includes dashboards, diagram views, asset views, search filters and relation views on an asset page.	Consumer
Views, Dashboards, Search filters	The Views, Dashboards, Search filters permission group contains global permissions that allow users to manage and share views, dashboards and search filters.	

Global permission	Description	Required license
Manage shared Views, Dashboards, Search filters	The Views, Dashboards, Search filters > Manage shared Views, Dashboards, Search filters global permission allows users to share, edit and delete views, dashboards and search filters that are shared.	Author
Manage your own Views, Dashboards, Search filters	The Views, Dashboards, Search filters > Manage your own Views, Dashboards, Search filters global permission allows users to edit and delete your own views, dashboards and search filters.	Consumer
Share your own Views, Dashboards, Search filters	The Views, Dashboards, Search filters > Share your own Views, Dashboards, Search filters global permission allows users to share your own views, dashboards and search filters.	Consumer
Workflow	The Workflow permission group contains global permissions that allow users to manage workflows.	
Manage all workflows	The Workflow > Manage all workflows global permission allows users to see, reassign and delete all running workflow tasks.	Author
Use workflow message events	<p>The Workflow > Use workflow message events global permission allows users to retrieve workflow messages.</p> <div data-bbox="491 1608 1222 1751" style="border: 1px solid #ccc; padding: 5px; background-color: #f9f9f9;"> <p>Note This is used for API users. For more information, see Workflow permissions.</p> </div>	Consumer

Resource permissions

A resource permission is a [permission](#) that applies to a resource and its children. They are combined into [resource roles](#) to create [responsibilities](#).

For an overview of the permissions in each packaged resource role, see the online version of this documentation.

Resource permission	Description	Required license
Asset	The Asset permission group allow users to work with assets.	
Add	The Asset > Add resource permission allows users to create assets.	Author
Remove	The Asset > Remove resource permission allows users to delete assets.	Author
Update	<p>The Asset > Update resource permission allows users to edit assets.</p> <div style="background-color: #f0f0f0; padding: 5px; margin-top: 10px;"> <p>Note This only refers to the asset name and automatic hyperlinking.</p> </div>	Author
Update Status	The Asset > Update Status resource permission allows users to change the status of assets.	Author
Update Type	The Asset > Update Type resource permission allows users to change the asset type of assets.	Author
Attribute	The Asset > Attribute permission group allow users to work with attributes of assets.	

Resource permission	Description	Required license
Add	<p>The Asset > Attribute > Add resource permission allows users to add characteristics to assets.</p> <p>Tip If you want to use images and attachments in attributes of assets, you also need the Attachment > Add permission.</p>	Author
Remove	<p>The Asset > Attribute > Remove resource permission allows users to remove characteristics from assets.</p>	Author
Update	<p>The Asset > Attribute > Update resource permission allows users to edit characteristics of assets.</p> <p>Tip If you want to use images and attachments in attributes of assets, you also need the Attachment > Add permission.</p>	Author
Data	<p>The Asset > Data permission group allow users to work with data from data sources.</p>	
Access Data	<p>The Asset > Data > Access Data resource permission allows users to create Tableau provision files.</p>	Consumer
View Samples	<p>The Asset > Data > View Samples resource permission allows users to see sample data of data sources.</p>	Consumer

Resource permission	Description	Required license
Responsibilities	The Asset > Responsibilities permission group allow users to manage the responsibilities of assets.	
Add	The Asset > Responsibilities > Add resource permission allows users to create responsibilities for assets.	Author
Remove	The Asset > Responsibilities > Remove resource permission allows users to delete responsibilities from assets.	Author
Update	The Asset > Responsibilities > Update resource permission allows users to edit responsibilities of assets.	Author
Tags	The Asset > Tags permission group allow users to work with tags.	
Update	The Asset > Tags > Update resource permission allows users to edit and delete tags on asset pages and asset tables.	Consumer
Attachment	The Attachment permission group allow users to manage attachments.	
Add	The Attachment > Add resource permission allows users to add attachments to resources.	Consumer
Remove	The Attachment > Remove resource permission allows users to remove attachments from resources.	Consumer

Resource permission	Description	Required license
Update	The Attachment > Update resource permission allows users to edit attachments of resources.	Consumer
Comment	The Comment permission group allow users to work with comments.	
Add	<p>The Comment > Add resource permission allows users to add comments to resources.</p> <p>Tip If you want to use images and attachments in comments, you also need the Attachment > Add permission.</p>	Consumer
Remove	The Comment > Remove resource permission allows users to delete comments from resources.	Author
Update	<p>The Comment > Update resource permission allows users to edit comments of resources.</p> <p>Tip If you want to use images and attachments in comments, you also need the Attachment > Add permission.</p>	Author
Community	The Community permission group allow users to manage communities.	
Add	<p>The Community > Add resource permission allows users to create and edit communities.</p> <p>Tip If you want to use images and attachments in the description of communities, you also need the Attachment > Add permission.</p>	Author

Resource permission	Description	Required license
Configure external system	The Community > Add resource permission allows users to set up connections to external data sources.	Author
Remove	The Community > Remove resource permission allows users to delete communities.	Author
Update	<p>The Community > Update resource permission allows users to edit communities.</p> <div style="border-left: 2px solid green; padding-left: 10px; margin-top: 10px;"> <p>Tip If you want to use images and attachments in the description of communities, you also need the Attachment > Add permission.</p> </div>	Author
Responsibilities	The Community > Responsibilities permission group allow users to manage the responsibilities of communities.	
Add	The Community > Responsibilities > Add resource permission allows users to create responsibilities for communities.	Author
Remove	The Community > Responsibilities > Remove resource permission allows users to delete responsibilities from communities.	Author
Update	The Community > Responsibilities > Update resource permission allows users to edit responsibilities of communities.	Author
Domain	The Domain permission group allow users to manage domains.	



Resource permission	Description	Required license
Add	<p>The Domain > Add resource permission allows users to create and edit domains.</p> <p>Tip If you want to use images and attachments in the description of domains, you also need the Attachment > Add permission.</p>	Author
Remove	The Domain > Remove resource permission allows users to delete domains.	Author
Update	<p>The Domain > Update resource permission allows users to edit domains.</p> <p>Tip If you want to use images and attachments in the description of domains, you also need the Attachment > Add permission.</p>	Author
Responsibilities	The Domain > Responsibilities permission group allow users to manage the responsibilities of domains.	
Add	The Domain > Responsibilities > Add resource permission allows users to create responsibilities for domains.	Author
Remove	The Domain > Responsibilities > Remove resource permission allows users to delete responsibilities from domains.	Author

Resource permission	Description	Required license
Update	The Domain > Responsibilities > Update resource permission allows users to edit responsibilities of domains.	Author
Rating	The Ratings permission group allow users to work with ratings.	
Add	The Rating > Add resource permission allows users to rate assets, edit and delete your own ratings.	Consumer
Remove	The Rating > Remove resource permission allows users to delete other users' ratings.	Author
Update	The Rating > Update resource permission allows users to edit other users' ratings	Author
Validation	The Validation permission group allow users to validate assets.	
Validation execution	The Validation > Validation Execution resource permission allows users to manually start validation of an asset from the asset page or an asset table.	Author
View Permissions	The View Permissions permission group allow users to manage the view permissions of domains and communities.	
Edit View Permissions	The View Permissions > Edit View Permissions resource permission allows users to edit the view permissions of domains and communities.	Author

Resource permission	Description	Required license
Workflow	The Workflow permission group allow users to manage workflows tasks.	
Manage Workflows	<p>The Workflows > Manage Workflows resource permission allows users to see all running workflow tasks.</p> <div style="border: 1px solid #ccc; padding: 5px; background-color: #f9f9f9;"> <p>Note It does not give you permission to cancel or reassign tasks, as this is determined by the workflow definition.</p> </div>	Author

Enable permission to use tags

To enable the permission to use tags, follow these steps:

1. In the main menu, click , then  **Settings**.
 - » The [Collibra DGC settings page](#) opens.
2. Click **Roles and permissions**.
 - » The [roles and permissions settings](#) appear on the **Roles** → **Global** tab page.
3. In the tab pane, click **Permissions** → **Resource**.
 - » The matrix of resource permissions and roles appears.
4. In the table, look up **Tags**.
5. In the role column, click  to enable the permission.



If you see , that role is permitted to use tags.

Name ▾	Assignee	Business Steward	Owner
Tags	✓	✗	✓
Update	✓	✗	✓

A user with one of the selected resource roles on an asset can use (add, update and delete) tags on that asset.

Disable the permission to use tags

To disable the permission to use tags, follow these steps:

1. In the main menu, click , then  **Settings**.
 - » The [Collibra DGC settings page](#) opens.
2. Click **Roles and permissions**.
 - » The [roles and permissions settings](#) appear on the **Roles** → **Global** tab page.
3. In the tab pane, click **Permissions** → **Resource**.
 - » The matrix of resource permissions and roles appears.
4. In the table, look up **Tags**.
5. In the role column, click  to disable the permission for the role.

If you see , that role is not permitted to use tags.

Name ▾	Assignee	Business Steward	Owner
Tags			
Update			

Roles

A role is a collection of [permissions](#) that can be assigned to [users](#) and [user groups](#).

Role types

The role type determines whether the permissions in the role apply to resources or the Collibra Data Governance Center applications.

Collibra DGC has two types of roles:

- [Global roles](#)
- [Resource roles](#)

Global roles

A global role is a role that consists of [global permissions](#). You assign a user to a global role to determine which Collibra applications the user can use.

Global roles

The following table contains the packaged global roles.



Global role	Description
Assessments	A user who can access Assessments.
Asset Grid Admin	A user who can access Asset Grid.
Catalog	A user who can access Data Catalog. The global permissions in this role only require a consumer license.
Catalog Author	A user who can access Data Catalog. Users with this role can also create, edit and delete advanced data types .
Data Dictionary	A user who can access the Data Dictionary application, which contains all the technical metadata of the physical data sources and other data assets.
DataSteward	A user who can access the Data Stewardship application for viewing tags, Business Dimensions and the organization structure, including the responsibilities of the communities and domains.
DataSteward Author	A user who can access the Data Stewardship application to see tags, Business Dimensions and the organization structure, including the responsibilities of the communities and domains. Users with this role can also manage tags on the tags overview page .
Edge integration engineer	A user who can add, edit and delete Edge connections and capabilities.
Edge manager	A user who can create, edit and delete Edge sites.
Edge site	A user who can create a connection between itself, as an Edge site, and Collibra Data Governance Center. <div style="border: 1px solid #ccc; background-color: #f9f9f9; padding: 10px; margin-top: 10px;"> <p>Note The user is not a person, but an Edge site. The user is automatically created when you install an Edge site.</p> </div>
Edge site administrator	A user who can download the download and installer files to install an Edge site.

Global role	Description
Glossary	<p>A user who can access the Business Glossary application.</p> <p>Users with this role are typically allowed to:</p> <ul style="list-style-type: none"> • Access all business semantics glossary functionality and workflows concerning business term proposal and approval, data element usage, structure and glossary alignment. • Define and manage the business asset types, data structure asset types, data element asset types and technology asset types and their subtypes. • Define and manage complex relation types such as field mapping.
Data Helpdesk	<p>A user who can access the Data Helpdesk application, where users can log issues and check issue statuses and assignees.</p>
Policy Manager	<p>A user who can access the Policy Manager application, which is a collection of all governance assets.</p>
ReferenceData	<p>A user who can access the reference data accelerator.</p> <p>Users with this role are typically allowed to:</p> <ul style="list-style-type: none"> • Access all reference data functionality and workflows concerning code proposal, code approval and code mapping. • Define and manage the crosswalk, code value and codes set asset types and their subtypes. • Define and manage complex relation types such as code mapping.
SysAdmin	<p>A user who can configure and manage the Collibra Data Governance Center.</p> <p>Users with this role are typically allowed to:</p> <ul style="list-style-type: none"> • Access and modify the  Settings. • Define and manage the operating model.

Create a global role

You can create a new [global role](#). For example, you can do this if the packaged roles don't meet your specific needs.

Steps

1. In the main menu, click , then  **Settings**.
 - » The [Collibra DGC settings page](#) opens.
2. Click **Roles and permissions**.
 - » The [roles and permissions settings](#) appear on the **Roles** → **Global** tab page.
3. In the tab pane, click **Roles**.
 - » The overview of global roles appears.
4. Above the table, to the right, click **Add**.
 - » The **Global Role Creation** dialog box appears.
5. Enter the required information.

Field	Description
Name	Type a name for the role.
Description	Type a description for the role.
Users	Enter the users or user group that are granted this role. <div style="border: 1px solid #ccc; padding: 5px; background-color: #f9f9f9;"> <p>Note You can still assign a global role to a user later.</p> </div>

6. Click **Save**.

What's next?

- [Determine](#) which global permissions are included in this role.
- [Assign](#) users to the role.

Edit a global role



You can edit a [global role](#). You can do so, for example, if you want to edit the name or the description of a role.

Note Do not confuse this with [adding or removing](#) global permissions.

Prerequisites

- You have a [global role](#) that has the System administration [global permission](#).

Steps

1. In the main menu, click , then  **Settings**.
 - » The [Collibra DGC settings page](#) opens.
2. Click **Roles and permissions**.
 - » The [roles and permissions settings](#) appear on the **Roles** → **Global** tab page.
3. Double-click a cell.
 - » The cell editor appears.
4. Edit the cell.
5. Click .



Add or remove global permissions to a global role

You can determine which [global permissions](#) are included in a [global role](#).

Prerequisites

- You have a [global role](#) that has the System administration [global permission](#).

Steps



1. In the main menu, click , then  **Settings**.
 - » The [Collibra DGC settings page](#) opens.
2. Click **Roles and permissions**.
 - » The [roles and permissions settings](#) appear on the **Roles** → **Global** tab page.
3. In the tab pane, click **Permissions** .
 - » The matrix of global permissions and roles appears.
4. If required, add or remove columns:
 - a. In the content toolbar, click  → <the name of the role>.
5. Above the table, to the right, click **Edit**.
 - » You can now edit the matrix of permissions and roles.

6. Select or clear the checkboxes to add permissions to, or remove them from a role.
7. Above the table, to the right, click **Save**.

Assign a global role to a user or a user group

You can assign a [global role](#) to a [user](#) or [user group](#).

Steps

1. In the main menu, click , then  **Settings**.
 - » The [Collibra DGC settings page](#) opens.
2. Click **Roles and permissions**.
 - » The [roles and permissions settings](#) appear on the **Roles** → **Global** tab page.
3. In the row of the role to which you want to assign users or user groups, double-click the **Members** column.
4. Start typing in the field and click the user or user group that you want to assign.
Press `Enter` to assign multiple users or groups at once.
5. Click **Save**.



Delete a global role

You can delete a [global role](#). For example, you can do this if you no longer need a specific role.

Prerequisites

- You have a [global role](#) that has the System administration [global permission](#).

Steps

1. In the main menu, click , then  **Settings**.
 - » The [Collibra DGC settings page](#) opens.
2. Click **Roles and permissions**.
 - » The [roles and permissions settings](#) appear on the **Roles** → **Global** tab page.
3. In the row of the role, click .

- » The **Delete** dialog box appears.
4. Click **Delete**.

Resource roles and permissions

A resource role is a role that consists of resource permissions and applies to a resource and its children. For example, if you assign a resource role to a domain, it also applies to all assets in the domain. If you assign a resource role to a community, it also applies to all its subcommunities, domains and assets in the community. The purpose of resource roles is to grant resource permissions to users through a responsibility. For example, they determine which users can edit assets via the asset page or in a workflow.

In this chapter

Resource roles

The following table shows the packaged resource roles.

Resource role	Description
Assignee	A user who is assigned to complete a task.
Business Steward	A user who is involved in daily, business-related decisions about the best ways to turn policy into practice.
Business User	A user with responsibility over a domain, subject or process.
Chief Data Officer	A high-level decision maker who is responsible for enterprise-wide data governance and the utilization of information as an asset.
CISO	A senior-level executive within an organization responsible for establishing and maintaining the enterprise vision, strategy, and program to ensure information assets and technologies are adequately protected.

Resource role	Description
Community Manager	A user who acts as liaison between all the different roles and groups. This user can also analyze and pack up issues, so that the data governance council can make decisions. Assigning and removing roles and responsibilities are also among this user's duties.
Council Member	A user who represents business and technical data stakeholder functional groups.
Data Analyst Level 1	This role is assigned to a user on a data element level when this user is allowed to see a data sample of this data element.
Data Analyst Level 2	This role is assigned to a user on a data element level when this user has full access to the data.
Data Category Manager	
Data Custodian	A user who collects and holds information on behalf of a data provider or requester and who is responsible for managing the use, disclosure and protection of data.
Data Protection Officer	A Data Protection Officer (DPO) is an enterprise security leadership role required by the General Data Protection Regulation (GDPR). The DPO is responsible for overseeing data protection strategy and implementation, to ensure compliance with the relevant regulations.
Data Steward	A Data Steward is a role within an organization responsible for utilizing an organization's data governance processes to ensure fitness of data elements - both the content and metadata. Data Stewards have a specialist role that incorporates processes, policies, guidelines and responsibilities for administering organizations' entire data in compliance with policy and/or regulatory obligations. A data steward may share some responsibilities with a data custodian.
Issue Manager	A user who identifies and prioritizes issues with business impact, directs resources to the most urgent issues and reassigns tasks to different users in the absence of the assigned user.
Normal	A user who does not have any assigned responsibilities.

Resource role	Description
Owner	A user who is responsible for accuracy, integrity, and timeliness of an information asset and for establishing the controls for its generation, collection, processing, access, dissemination and disposal.
Privacy Steward	A role within an organization responsible for utilizing an organization's data governance processes to ensure compliance. Data Privacy Stewards have a specialist role that incorporates processes, policies, guidelines and responsibilities for determining which policy and/or regulatory privacy obligations organizations' data should comply with.
Requester	A user who makes a request related to an information asset.
Reviewer	A user who is assigned to review an outcome of a user task.
Stakeholder	A user who can use, affect or be affected by an asset under discussion. This user wants to be involved or notified, but can only provide comments and reviews.
Subject Matter Expert	A user who performs specific data-related tasks and is consulted to provide guidance and feedback to individuals with stewardship responsibilities.
Technical Steward	A user who is involved in daily, data-related decisions, executes business decisions and implements business requirements in a technology platform.



Create a resource role

You can create a new [resource role](#). You can do so, for example, if the packaged resource roles don't meet your specific needs.

Prerequisites

- You have a [global role](#) that has the System administration [global permission](#).

Steps

- In the main menu, click , then  **Settings**.
 - » The [Collibra DGC settings page](#) opens.

2. Click **Roles and permissions**.
 - » The [roles and permissions settings](#) appear on the **Roles** → **Global** tab page.
3. In the tab pane, click **Roles**→ **Resource**.
 - » The overview of resource roles appears.
4. Above the table, to the right, click **Add**.
 - » The **Resource Role Creation** dialog box appears.
5. Enter the required information.

Field	Description
Name	Type a name for the role.
Description	Type a description for the role.

6. Click **Save**.

What's next?

As new resource roles are created with no resource permissions included, you have to [add](#) them for the new resource role.

- As new resource roles are created with no resource permissions included, you have to [add](#) them for the new resource role.
- [Create](#) a responsibility to assign users to the roles for a resource.

Edit a resource role



You can edit a [resource role](#). You can do so, for example, if you want to edit the name or the description of a role.

Note Do not confuse this with [adding or removing](#) resource permissions.

Prerequisites

- You have a [global role](#) that has the System administration [global permission](#).

Steps

1. In the main menu, click , then  **Settings**.
 - » The [Collibra DGC settings page](#) opens.
2. Click **Roles and permissions**.
 - » The [roles and permissions settings](#) appear on the **Roles** → **Global** tab page.
3. In the tab pane, click **Roles** → **Resource**.
 - » The overview of resource roles appears.
4. Double-click a cell.
 - » The cell editor appears.
5. Edit the cell.
6. Click .



Add or remove resource permissions for a resource role

You can determine which [resource permissions](#) are included in a [resource role](#).

Prerequisites

- You have a [global role](#) that has the System administration [global permission](#).

Steps

1. In the main menu, click , then  **Settings**.
 - » The [Collibra DGC settings page](#) opens.
2. Click **Roles and permissions**.
 - » The [roles and permissions settings](#) appear on the **Roles** → **Global** tab page.
3. In the tab pane, click **Permissions** → **Resource**.
 - » The matrix of resource permissions and roles appears.
4. If required, add or remove columns:
 - a. In the content toolbar, click  → <the name of the role>.
5. Above the table, to the right, click **Edit**.
 - » You can now edit the matrix of permissions and roles.
6. Select or clear the checkboxes to add permissions to, or remove them from a role.
7. Above the table, to the right, click **Save**.



Delete a resource role

You can delete a [resource role](#). For example, you can do this if you no longer need a specific role.

Prerequisites

- You have a [global role](#) that has the System administration [global permission](#).

Steps

1. In the main menu, click , then  **Settings**.
 - » The [Collibra DGC settings page](#) opens.
2. Click **Roles and permissions**.
 - » The [roles and permissions settings](#) appear on the **Roles** → **Global** tab page.
3. In the tab pane, click **Roles** → **Resource**.
 - » The overview of resource roles appears.
4. In the row of the role, click .
 - » The **Delete** dialog box appears.
5. Click **Delete**.

Responsibilities

Responsibilities are used to assign a [resource role](#) to one or more [users](#) and/or [user groups](#). Based on their responsibilities, users can act on the [permissions](#) conveyed to them via the resource role.

Responsibilities

A responsibility is the assignment of one or more [users](#) and/or [user groups](#) to a [resource role](#) for a resource.

Based on their responsibilities, users can act on the [permissions](#) conveyed to them via the resource role.

Child resources always inherit the responsibilities from their parent resources:

- If the resource is a community, the responsibilities are inherited by subcommunities, domains and assets in the community. For example, if you are a Business Steward for a certain community, you are a Business Steward for all the subcommunities, domains and assets inside that community.
- If the resource is a domain, the responsibilities are inherited by the assets in the domain.
- If the resource is an asset, the responsibilities only apply to the asset itself, because assets never have children.

Example

Suppose the following setup:

- Anita Morrison is assigned the Community Manager resource role for a community called "Enterprise".
- John Fisher is assigned the Business Steward resource role for a domain called "Critical Data Elements" in the "Enterprise" community.
- Joanna Zhou is assigned the Owner resource role for a domain called "Critical Data Elements" in the "Enterprise" community.
- William Parker is assigned the Owner resource role for an asset called "Customer Revenue" in the "Critical Data Elements" domain.

This leads to the following responsibilities:

Resource	Direct responsibilities	Inherited responsibilities
Enterprise community	<ul style="list-style-type: none"> • Anita Morrison as Community Manager 	<ul style="list-style-type: none"> • None
Critical Data Elements domain	<ul style="list-style-type: none"> • John Fisher as Business Steward • Joanna Zhou as Owner 	<ul style="list-style-type: none"> • Anita Morrison as Community Manager
Customer Revenue asset	<ul style="list-style-type: none"> • William Parker as Owner 	<ul style="list-style-type: none"> • Anita Morrison as Community Manager • John Fisher as Business Steward • Joanna Zhou as Owner

Note You can [view direct and inherited responsibilities](#) of a resource in different places.

View responsibilities for a resource

You can view the [responsibilities](#) for a resource in the following locations:





- In the **Responsibilities** tab of a resource.
- In any view that displays communities, domains or assets, in the specific column or field for that role.
 - a. Open any view in table or tiles mode.
 - b. Do one of the following:
 - In tile mode: [add](#) the required fields.
 - In table mode, [add](#) the required column.

Note

- Each role has its own field or column.
- Depending on the [settings](#) in Collibra Console, you may also see the inherited responsibilities.

- In the **Responsibilities** tab of a user's profile page.

Tip You can also view your own responsibilities.

- a. [Open](#) a profile page.
 - b. In the tab pane, click  **Responsibilities**.
 - » The [Responsibilities](#) page appears.
- In the **Responsibilities** tab of a user group page.
 - a. Open a group page.
 - i. In the main menu, click , then  **Settings**.
 - » The [Collibra DGC settings page](#) opens.
 - ii. Click **Users and groups**.
 - » The [users and groups settings](#) appear on the **Users** tab page.
 - iii. In the tab pane, click **Users** → **Groups**.
 - » The user group table appears.
 - b. In the tab pane, click  **Responsibilities**.
 - » The [Responsibilities](#) page appears.

- In the **Preview** pane of an asset, for example on an asset page.

Note The preview pane only shows the direct responsibilities.

The Responsibilities page

The **Responsibilities** page shows the [view permissions](#) and the [responsibilities](#) of a resource.

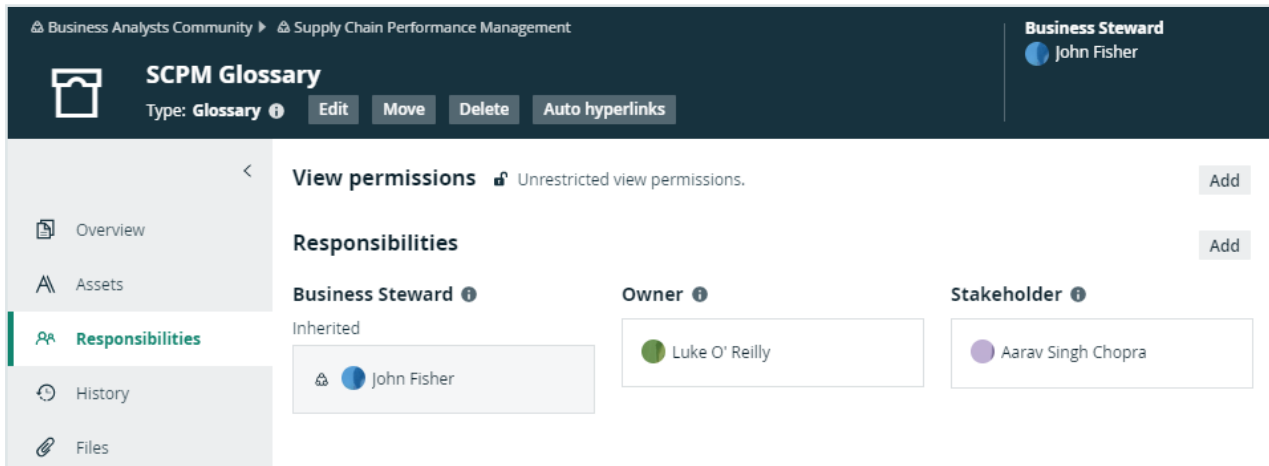

The background colors of the responsibilities show where the responsibility comes from.

Color	Description
Gray	The user or group inherited the role.
White	The user or group was directly assigned to this role for the resource.

If a user or group has a responsibility but not the required view permissions, a warning appears in the box. For example, a user was assigned the Steward role for a resource but does not have view permissions for it.

For information on view permissions, see the Collibra Data Governance Center Administration Guide.

Create a responsibility

You can create a responsibility:

- By assigning a resource role to a user or user group on the responsibilities page of a resource.
- By adding a user in the table column of a role.
- By [editing](#) an existing responsibility.

Important For optimal performance and ease of use, we recommend that you create responsibilities mainly on domains and communities and not directly on assets. Creating responsibilities directly on large amounts of assets may lead to decreased performance.



Assign a resource role to a user or user group on the responsibilities page

1. Open a community, domain or asset page.
2. In the tab pane, click  **Responsibilities**.
 - » The [Responsibilities](#) page appears.
3. Above the table, to the right, click **Add**.
 - » The **Add responsibility** dialog box appears.
4. Enter the required information.

Option	Description
Role	Enter the role that you want to assign to a user or group for this resource.
People	Enter the users and user groups to which you want to assign a role for this resource.

5. Click **Add**.
 - » The users or groups with the assigned role are now displayed in the **Responsibilities** table.

Tip

- If you want to assign a user or user group a resource role that other users or groups already have for this resource, you can click  and add them in the **People** field in the **Assign role** box.
- If there are only inherited roles,  is not available.

Assign a role to a user or user group for a resource from a table

1. Open a table that displays communities, domains or assets.
2. If required, [add](#) the column of the role that you want to assign to the user.
3. Do one of the following:
 - Double-click a cell in the column of the role.
 - Hover your mouse pointer over a cell in the column and click .
4. Click in the field and enter the user or user group.
5. If required, select **Apply to visible rows**.

This will create the responsibilities for all visible users.

Tip You can [filter](#) the columns first, to assign a role to a user for specific resources in one go.

6. Click .

Edit a responsibility

You can edit a [responsibility](#):

- by [deleting](#) it and [creating](#) a new one.
- in an asset table.

Note You cannot edit inherited responsibilities.

Edit a responsibility in a table

1. Open a table that displays communities, domains or assets.
2. If required, [add](#) the column of the role that you want to edit.

Warning Depending on the [settings](#) in Collibra Console, you may also see the inherited responsibilities. You cannot edit these inherited responsibilities.

3. Do one of the following:
 - Double-click a cell in the column of the role.
 - Hover your mouse over a cell in the column and click .

4. Edit the responsibility:

- Click in the field and enter a new user or user group.
- Click  next to the user or user group to remove the user or user group.
- If required, select **Apply to visible rows**.

This will edit the responsibilities of all visible users.

Tip You can **filter** the columns first to assign a user to specific resources in one go.

5. Click .



Delete a responsibility

You can delete a **responsibility**:

- From the **responsibilities page** of a resource.
- From a table.

Note You cannot delete inherited assignments.

Delete a responsibility from the responsibilities page of a resource

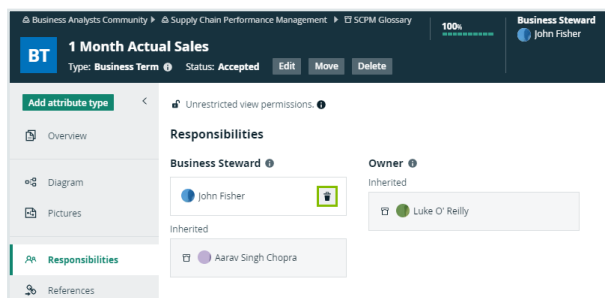

1. Open a community, domain or asset page.
2. In the tab pane, click  **Responsibilities**.
 - » The **Responsibilities** page appears.
3. In the **Responsibilities** table, click  next to the name of the user or group that you want to remove.

4. Click **Delete** to confirm.

Delete responsibilities for a resource from a table

1. Open a table that displays communities, domains or assets.
2. If required, [add](#) the column of the role that you want to edit.

Warning Depending on the [settings](#) in Collibra Console, you may also see the inherited responsibilities. You cannot delete these inherited responsibilities.

3. Do one of the following:
 - Double-click a cell in the column of the role.
 - Hover your mouse over a cell in the column and click .
4. In the cell editor, click  next to the user or user group.
5. If required, select **Apply to visible rows**.

This will delete the responsibilities from all visible users.

Tip You can [filter](#) the columns first to assign a user to specific resources in one go.

6. Click .

Managing workflows in Collibra DGC

A workflow in Collibra Data Governance Center is used to automate processes. Collibra DGC comes with many workflows, and you can always add new ones.

When you decide how to configure your Collibra DGC workflows, consider that the workflow events mechanism is not designed for mass import. Avoid triggering workflows as a result of an import operation because it has the potential of impacting the performance of your environment. If you must use workflows after importing large amounts of data, you should:

- Configure all script tasks to run asynchronously to prevent slowing down the import.
- Keep the number of [start events](#) to a minimum.
- Restrict the [scope](#) of the workflow as much as possible.

Tab pages

The **Workflows** settings page of the [Collibra DGC settings](#) is split in several tab pages:

Tab page	Description
Definitions	This tab page allows you to view and edit workflow definitions.
Instances	This tab page allows you to view and edit instances of running workflows.

Packaged workflow deployments

In general, when you start your Collibra Data Governance Center environment, all missing packaged workflows are deployed, enabled and configured with the default settings.

Note OOTB workflows are not automatically updated after an upgrade.

The following list of rules applies to OOTB workflow deployments in version 5.1 or newer when you (re)start an environment:

- OOTB workflows that are missing (deleted or never deployed), are deployed, enabled and configured with the default settings.
- Deployed OOTB workflows are not automatically updated, even if they are not customized. To install a new version of an OOTB workflow, do either of the following:
 - Remove the existing workflow and then restart the environment. See [Deploy updated packaged workflows](#).
 - Download the updated workflows from the [Community Downloads page](#), customize them if necessary, and [deploy](#) them to your environment.
- If you created a workflow with the name of an OOTB workflow and the actual OOTB workflow is not deployed, the actual OOTB workflow is deployed, enabled and configured with a name having an **OOTB_** prefix, for example **OOTB_Approval Process**.

Tip [Disable](#) the OTTB workflows you do not want to use. If you delete them, they are redeployed when the environment is restarted.

Workflow engine upgrade

In Collibra Data Governance Center 5.6 or newer, the workflow engine uses [Flowable](#) instead of [Activiti](#) because of the lack of development and support for Activiti.

The upgrade has the following impact:

- When you upgrade from version 5.5 or older to Collibra Data Governance Center 5.6 or newer, all workflows in your environment are redeployed for the new workflow engine. Running instances of workflows continue to use the old workflow engine until their completion, while new instances run with the new workflow engine.
- The upgrade to Flowable ensures the [packaged workflows](#) remain functional.

Tip Test your custom workflows thoroughly, even if they seem to work as expected.



Note Your workflows could show unexpected behavior, especially after upgrading from version 4.6.x.

- When you reference the API v2 name space (<http://www.collibra.com/apiv2>), the workflow is validated against V2 methods and deprecated V1 methods trigger a **method does not exist** error when called.

View and edit workflows

You can view both the XML schema and a visual representation of the workflow definition in Collibra Data Governance Center.

You must have the Sysadmin global role or a global role that has at least the Workflow Administration global permission to access this page:

1. In the main menu, click , then  **Settings**.
 - » The [Collibra DGC settings page](#) opens.
2. Click **Workflows**.
 - » The [Workflows](#) settings page appears on the **Definitions** tab page.
3. Select a workflow.
4. In the tab pane, click **Flow**.

Flow

This is the diagram showing the workflow definition.

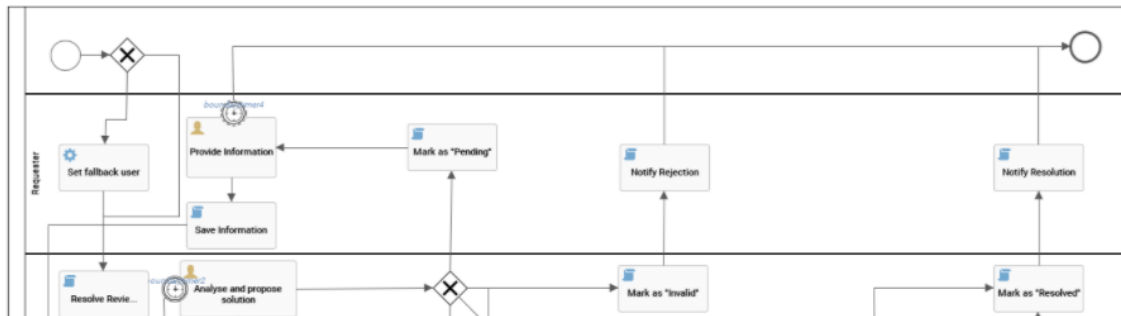

Tip To view large diagrams, drag the image or click  to enter full screen.

The lower part of the page contains the raw workflow definition:

Read-only mode

This is raw workflow definition.

```

1 <?xml version="1.0" encoding="UTF-8"?>
2 <definitions xmlns="http://www.omg.org/spec/BPMN/20100524/MODEL" xmlns:xsi="http://www.w3.org/2001/XMLSchema-instance"
3   xmlns:xsd="http://www.w3.org/2001/XMLSchema" xmlns:activiti="http://activiti.org/bpmn"
4   xmlns:bpmndi="http://www.omg.org/spec/BPMN/20100524/DI" xmlns:omgdc="http://www.omg.org/spec/DD/20100524/DC"
5   xmlns:omgdi="http://www.omg.org/spec/DD/20100524/DI" typeLanguage="http://www.w3.org/2001/XMLSchema"
6   expressionLanguage="http://www.w3.org/1999/XPath" targetNamespace="http://www.collibra.com/apiv2">
7   <collaboration id="Collaboration">
8     <participant id="pool1" name="Issue Management" processRef="issueManagement"></participant>
9     <messageFlow id="messageflow1" sourceRef="scripttask6" targetRef="callactivity1"></messageFlow>
10    <messageFlow id="messageflow2" sourceRef="scripttask6" targetRef="callactivity1"></messageFlow>
11    <messageFlow id="messageflow3" sourceRef="scripttask6" targetRef="callactivity1"></messageFlow>
12  </collaboration>
13  <process id="issueManagement" name="Issue Management" isExecutable="true">
14    <documentation>This process handles all issues. It will automatically be started when a new issue is created.
15      Roles are assigned dynamically by the process using the configured user expressions.
16  </documentation>
17  </process>

```

To edit workflows, follow the procedures described in the [Designing workflows](#) section. For minor updates, you can edit the XML schema directly :

1. Click  to edit the XML.
2. Click the **Save** button in the lower-right part of the page to save your changes and exit edit mode.

Note The changes you make are not reflected in [currently running instances](#) of the workflow.

Deploy a workflow



You deploy a workflow when you upload the workflow definition to Collibra Data Governance Center.

You can upload a workflow definition in ***.bpmn** or ***.bpmn20.xml** format.

Prerequisites

You have a [global role](#) with the Workflow Administration or the System Administration [global permission](#), for example Sysadmin.

Steps

1. In the main menu, click , then  **Settings**.
 - » The [Collibra DGC settings page](#) opens.
2. In the tab pane, click **Workflows** → **Definitions**.
3. Click  **Upload a file** and select the workflow definition you want to deploy or drag and drop your workflow in the upload section.
 - » An **Activity Queue** window displays the upload progress. In case the update fails, you see an error message.

Warning Uploading a workflow with the same process ID as an existing workflow in Collibra DGC replaces the existing workflow.

Note Collibra DGC does not accept two workflows with the same display name.

What's next





After a successful workflow deployment, [edit the workflow definition settings](#) in Collibra DGC.

Enable or disable workflows

You can enable or disable workflows from the workflow definitions table or from the individual workflow definition pages.







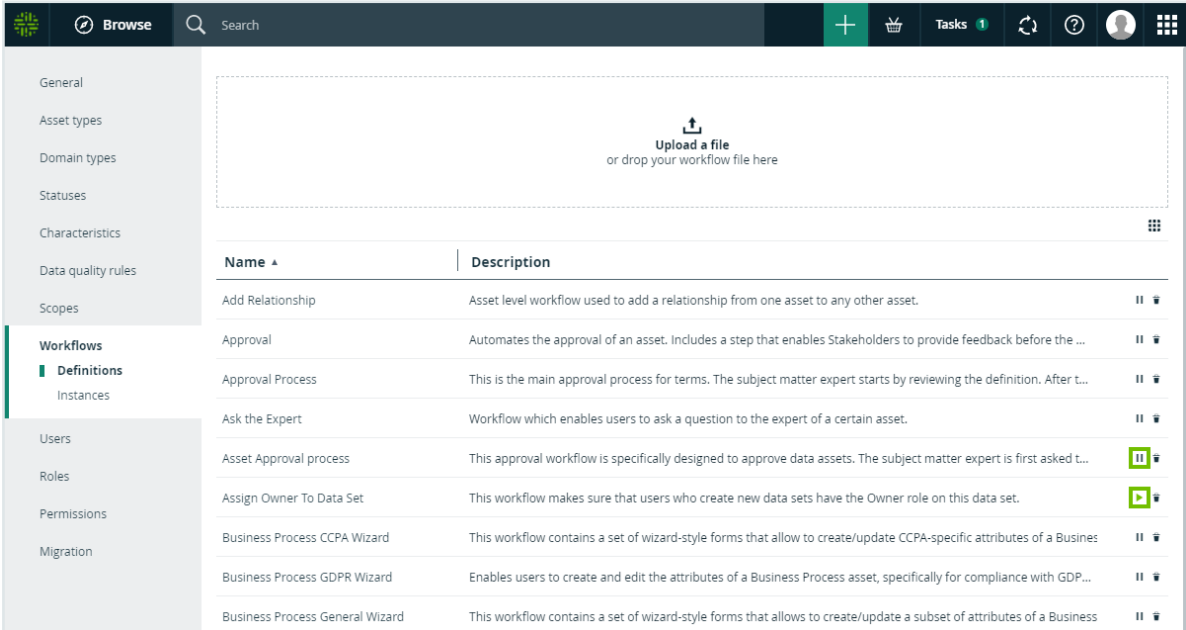











You must have the Sysadmin global role or a global role that has at least the Workflow Administration global permission to perform this action.

Enable or disable a workflow from the workflow definitions table



1. In the main menu, click , then  **Settings**.
 - » The [Collibra DGC settings page](#) opens.
2. In the tab pane, click **Workflows** → **Definitions**.
3. At the end of the row, click  or  to respectively enable or disable a workflow.



The screenshot shows the Collibra DGC settings page. The left sidebar contains a navigation menu with categories: General, Asset types, Domain types, Statuses, Characteristics, Data quality rules, Scopes, Workflows (selected), Definitions (sub-selected), Instances, Users, Roles, Permissions, and Migration. The main content area features a search bar and a table of workflow definitions. Above the table is a dashed box with an upload icon and the text 'Upload a file or drop your workflow file here'. The table has columns for Name and Description, and a right-hand column with control icons (play and stop).

Name	Description	
Add Relationship	Asset level workflow used to add a relationship from one asset to any other asset.	 
Approval	Automates the approval of an asset. Includes a step that enables Stakeholders to provide feedback before the ...	 
Approval Process	This is the main approval process for terms. The subject matter expert starts by reviewing the definition. After t...	 
Ask the Expert	Workflow which enables users to ask a question to the expert of a certain asset.	 
Asset Approval process	This approval workflow is specifically designed to approve data assets. The subject matter expert is first asked t...	 
Assign Owner To Data Set	This workflow makes sure that users who create new data sets have the Owner role on this data set.	 
Business Process CCPA Wizard	This workflow contains a set of wizard-style forms that allow to create/update CCPA-specific attributes of a Busines...	 
Business Process GDPR Wizard	Enables users to create and edit the attributes of a Business Process asset, specifically for compliance with GDP...	 
Business Process General Wizard	This workflow contains a set of wizard-style forms that allows to create/update a subset of attributes of a Business...	 

Enable or disable a workflow from the workflow definition page

1. In the main menu, click , then  **Settings**.
 - » The [Collibra DGC settings page](#) opens.

2. In the tab pane, click **Workflows** → **Definitions**.
3. Click the workflow you want to enable or disable.
4. At the right of the title bar, click ► or || to respectively enable or disable a workflow.



Workflow configuration options in Collibra DGC

After you have successfully deployed a workflow, the default settings are applied to it. You can change the default settings and the workflow behavior to your organization's needs.

In the overview of a workflow, you can change the header bar and some general workflow settings.

Workflows title bar



The title bar of workflow definition pages contains the name and status of the workflow and allows you to:

1. [Enable or disable the workflow.](#)
2. Edit the display name or status of the workflow.
3. [Delete the workflow.](#)

Note Collibra DGC does not accept two workflows with the same display name.

Workflow statuses description:

- **Deployed** A new workflow has been uploaded to Collibra Data Governance Center.
- **Enabled:** The workflow is active and can be used.
- **Disabled:** The workflow cannot be used. If the workflow is a step in another workflow, that step fails.



Note Once a workflow has been enabled, you cannot change the status back to **Deployed**.

View and edit workflow definition settings

The workflow definition settings are additional parameters that help you manage the workflow behavior and accessibility inside Collibra Data Governance Center.

(missing or bad snippet)

You must have the Sysadmin global role or a global role that has at least the Workflow Administration global permission to access this page:

1. In the main menu, click , then  **Settings**.
 - » The [Collibra DGC settings page](#) opens.
2. Click **Workflows**.
 - » The [Workflows](#) settings page appears on the **Definitions** tab page.
3. Select a workflow to view the definition settings.

Legitimate Interest Assessment Wizard
Status: Enabled

Overview

Flow

Description 1 Edit

The legitimate interest assessment (or balancing test) must ensure that when the Controller or a Third Party uses 'Legitimate Interest' as the legal basis for a processing activity, this does not conflict with the interests or fundamental rights and freedoms of individuals.

Applies To 2 Add Rules Edit

Asset

Asset type ↑	With status	In community/domain
Legitimate Interest A...	New	

1 Rule

Variables 3 Edit

These variables are accessible in the workflow.

Name	Description
mandatoryRoleIds	Please provide a list of comma-separated role id's
characteristicsProposerDefaultUserExp...	Please provide the default user expression for the
ownershipAcceptorRoleId	Please provide the id of the role that can decide if

Start Label 4 Edit

Update LIA

Start Events 5 Edit

There are no events attached to this workflow.

Roles 6 Edit

Start workflow
Owner, Business Steward

Stop workflow
Owner, Business Steward

Reassign tasks
Owner, Business Steward

Other 7

Any signed in user can start the workflow.
Any signed in user can start a workflow, independent of the role that user has.

Perform candidate user check on workflow start.
Workflow will fail to initialize if it contains a task without any candidate user.

Description

The description is a brief overview of the workflow. You can edit the description by:

- [Changing the diagram process properties.](#)
- [Editing the workflow XML](#) directly in Collibra Data Governance Center

Applies To

This section defines the scope of the workflow. This includes the type of resource the workflow applies to, optional restriction rules and where you can start the workflow from.

Click **Edit** to change the scope to any of the following:

- Asset
- Community
- Domain
- Global

Note When you change the scope, the rules are removed. If you are changing from or to the Global scope, the roles are also removed.

A global workflow is not restricted to any particular resource and can be added to dashboards.

When you defined the resource that the workflow applies to, you can add restriction rules to finetune the scope of the workflow.

Show me how

1. Click **Add**.
 - » A dialog box appears.

The screenshot shows the 'Applies To' dialog box with an 'Add' button. The 'Add' dialog box is open, showing the following configuration:

Asset Type	Restricted to community/domain, status
Business Term	(New)
Data Asset	> Business Analysts Community (Candidate)

The 'Add' dialog box contains the following fields:

- Type: Business Rule
- in domain community: New Policies & Business Rules
- with status: Candidate

Buttons: Cancel, Save

Note The available options depend on the selected scope.

2. Select the **Type**.

Tip Select **Asset** to associate the workflow with all asset types.

3. Select an optional domain or community the resource belongs to.

4. Select an optional status of the resource the workflow applies to.

5. Click **Save**.

» The restriction is added to the list. The workflow is restricted to the resources that meet the listed conditions.

Note If you select multiple restrictions, they use the logical **OR** function.

Variables

These are [configuration variables](#), a list of process variables that you can edit here.

Click **Edit** to edit the variables.

Note You can only edit configuration variables that have the **Writable** property set to *true* (default).

Note If you redeploy a workflow, the configured variables remain the same. If you delete a workflow and then deploy it again, the variables revert to the default values.

Start Label

The start label is the name of the workflow when it is visible as a button on a resource page or in the drop-down list when you add it as a button on a dashboard. Click **Edit** to edit the label.

Start Event

A start event is an event that triggers the workflow, for example starting the workflow when an asset is created. Click **Edit** to edit the start event list.

Combine the **Start Event** with **Applies To** settings to refine when the workflow is triggered.

Setting	Description
Asset Added	The workflow starts when a new asset is created.
Asset Removed	The workflow starts when an asset is deleted.
Asset Status Changed	The workflow starts when the status of an asset is changed.
Asset Domain Changed	The workflow starts when an asset is moved to another domain .
Asset Type Changed	The workflow starts when the type of an asset is changed.
Asset Attribute Changed	The workflow starts when an attribute of an assets is changed.
Asset Name Changed	The workflow starts when the full name of an asset is changed. This is the fully qualified name that must be unique within a domain. To learn more, see Identical asset names per domain .
Asset Display Name Changed	The workflow starts when the name of an asset is changed. This is the regular name that is used by default in most places in the user interface.
Asset Attribute Added	The workflow starts when an attribute is added to an asset.
Asset Attribute Removed	The workflow starts when an attribute is removed from an asset.
Domain Added	The workflow starts when a domain is added to a community.
Domain Removed	The workflow starts when a domain is removed from a community.
Role Granted	The workflow starts when a user or a user group is assigned a resource or a global role.

Setting	Description
Role Revoked	The workflow starts when a user or a user group is removed from a resource or a global role.
Workflow Started	The workflow starts when a workflow is manually started. <div style="background-color: #f0f0f0; padding: 5px;"> <p>Note Manually starting a workflow configured with this option also triggers the workflow.</p> </div>
Workflow Canceled	The workflow starts when a workflow is manually canceled. <div style="background-color: #f0f0f0; padding: 5px;"> <p>Note Manually canceling a workflow configured with this option also triggers the workflow.</p> </div>
Workflow Escalation	The workflow starts when a workflow user task is escalated. <div style="background-color: #f0f0f0; padding: 5px;"> <p>Note The packaged Escalation Process workflow is configured to start with this option.</p> </div>
Workflow task completed	The workflow starts when a workflow user task is completed.
User Added	The workflow starts when a new user account is created.
User Removed	The workflow starts when a user account is removed.
User Disabled	The workflow starts when a user account is disabled.
Comment Added	The workflow starts when a new comment is added to a resource.
Comment Removed	The workflow starts when a comment is removed from a resource.
Comment Changed	The workflow starts when a comment is edited.
Relation was added on an asset as head	The workflow starts when an asset becomes the head of a relation .
Relation was removed from an asset as head	The workflow starts when an asset is no longer the head of a relation.

Setting	Description
Relation was added on an asset as tail	The workflow starts when an asset becomes the tail of a relation.
Relation was removed from an asset as tail	The workflow starts when an asset is no longer the tail of a relation.
Asset Tag Event	The workflow starts when a tag is either added to or removed from an asset.
Data Classification Accepted	The workflow starts when a result of the data classification process is accepted.
Data Classification Rejected	The workflow starts when a result of the data classification process is rejected.
Data Classification Added	The workflow starts when a new data class is added to a column asset.
Data Classification Removed	The workflow starts when a data class is removed from a column asset, for example when the data class entry is deleted.
Data Classification Updated	The workflow starts when a data classification changes, for example when the confidence of a suggested match changes value.
Database Registration Completed	The workflow starts when a database is successfully registered .
Database Registration Failed	The workflow starts when the registration process of a database fails.

Note If you select multiple start events, they use the logical **OR** function.

Roles

The roles define the permissions to manage the workflow. For example, if a certain task must be urgently executed but the responsible person is on sick leave, a user with the defined role can reassign that task to somebody else.

You can enter roles for starting and stopping workflows or reassigning workflow user tasks. The roles you can enter depend on the **Applies To** settings:

- If the scope is **Global**, you can only specify global roles in these fields.
- In all other cases, only resource roles are allowed.

Note When specifying resource roles, only users that have the role for the specific resource can start and stop the workflow or reassign tasks.

Click  to edit the roles:

- **Start Workflow:** The button with the start label is available to users with these roles.
- **Stop Workflow:** The option to cancel the workflow is available to users with these roles.
- **Reassign Tasks:** The option to reassign the task is available to users with these roles.

Note The roles are removed when you are changing from or to the Global workflow scope.

Other

The section contains additional settings that determine who can start the workflow, how the workflow behaves in relation to the resource it applies to and if the workflow can be started from the global **Create** button.

Setting	Description
Any guest user can start the workflow.	<p>Indicates if guest users can start the workflow.</p> <p>If selected, users who are not signed in can start the workflow. When guest users start a workflow, some basic information, such as first name, last name and email address, is requested of them. That information can then be used to contact the user again, if needed.</p> <div data-bbox="496 555 1418 687" style="background-color: #f0f0f0; padding: 10px; border: 1px solid #ccc;"> <p>Note This check box overrides any roles that are specified in the Roles section.</p> </div> <p>If you select this check box, you cannot select the Any signed in user can start the workflow check box.</p>
Any signed in user can start the workflow.	<p>Indicates that any user who is signed in can start the workflow.</p> <div data-bbox="496 891 1418 1023" style="background-color: #f0f0f0; padding: 10px; border: 1px solid #ccc;"> <p>Note This check box overrides any roles that are specified in the Roles section.</p> </div> <p>If you select this check box, you cannot select the Any guest user can start the workflow check box.</p>
Perform candidate user check on workflow start.	<p>Checks if all workflow user tasks have a candidate user expression that can be resolved to at least one Collibra Data Governance Center user. If the check fails, you see an error message when the workflow starts.</p>
This workflow can only run once at the same time on a specific resource.	<p>Determines if you can start a workflow multiple times, simultaneously for the same resource.</p> <p>If selected the workflow can only be started once for a given resource. If any user tries to start the same workflow for the same resource, an error message is displayed. However, users can still start the same workflow for a different resource or another workflow for the same resource</p> <p>If Lock resource is also selected, no other workflow can start on the same resource while this workflow is running neither can this workflow start if any other workflow is running on the same resource.</p>
Show in global create.	<p>Only valid for workflows where the scope is set to Global, allows users to start the workflow from the global Create button.</p>

Duration variables

Both the **escalationDuration** and **escalationType** variables are only generated if there is no timer boundary event attached to the user task. In case there is one attached, it assumes that you will handle the escalation manually and no escalation variables are generated.

For more information about specifying a duration for the variables, please read about the ISO 8601 standard. Also note that we support business day durations. You can denote a business day duration by using a B instead of a P. If you use a business day duration, weekends are not taken into account. If a business day duration ends at a weekend, the first weekday after the weekend is used. You can use the business day duration just like a normal duration.

Other configuration settings

The following table contains a description of the **Other** configuration settings in Collibra DGC.

Setting	Description
Any guest user can start the workflow.	<p>Indicates if guest users can start the workflow.</p> <p>If selected, users who are not signed in can start the workflow. When guest users start a workflow, some basic information, such as first name, last name and email address, is requested of them. That information can then be used to contact the user again, if needed.</p> <div style="border: 1px solid #ccc; background-color: #f9f9f9; padding: 5px; margin: 10px 0;"> <p>Note This check box overrides any roles that are specified in the Roles section.</p> </div> <p>If you select this check box, you cannot select the Any signed in user can start the workflow check box.</p>

Setting	Description
Any signed in user can start the workflow.	<p>Indicates that any user who is signed in can start the workflow.</p> <div style="border: 1px solid #ccc; background-color: #f9f9f9; padding: 5px; margin: 5px 0;"> <p>Note This check box overrides any roles that are specified in the Roles section.</p> </div> <p>If you select this check box, you cannot select the Any guest user can start the workflow check box.</p>
Perform candidate user check on workflow start.	Checks if all workflow user tasks have a candidate user expression that can be resolved to at least one Collibra Data Governance Center user. If the check fails, you see an error message when the workflow starts.
This workflow can only run once at the same time on a specific resource.	Determines if you can start a workflow multiple times, simultaneously for the same resource.
	<p>If selected the workflow can only be started once for a given resource. If any user tries to start the same workflow for the same resource, an error message is displayed. However, users can still start the same workflow for a different resource or another workflow for the same resource</p> <p>If Lock resource is also selected, no other workflow can start on the same resource while this workflow is running neither can this workflow start if any other workflow is running on the same resource.</p>
Show in global create.	Only valid for workflows where the scope is set to Global , allows users to start the workflow from the global Create button.

Packaged variables for workflows

Below is a list of variables that you can use in workflows.

Variable	Description
address_commentsDueDate	Due date as duration for the address_comments task.
address_commentsTaskNotification	Indicates if a notification email for the address_comments task has to be sent.

Variable	Description
address_commentsEscalationDuration	Time before the address_comments task is escalated.
address_commentsEscalationType	Type of escalation for the address_comments task.
comment_provideDueDate	Due date as duration for the comment_provide task.
comment_provideEscalationDuration	Time before the comment_provide task is escalated.
comment_provideEscalationType	Type of escalation for the comment_provide task.
comment_provideTaskNotification	Indicates if a notification email for the comment_provide task has to be sent.
commentTimeoutDuration	Time before the comment_provide task times out.
correct_definitionDueDate	Due date as duration for the correct_definition task.
correct_definitionEscalationDuration	Time before the correct_definition task is escalated.
correct_definitionEscalationType	Type of escalation for the correct_definition task.
correct_definitionTaskNotification	Indicates if a notification email for the correct_definition task has to be sent.
reviewCompletionPercentage	Percentage of user candidates that is required to review the definition before the task is completed.
reviewTimeoutDuration	Time before the review process is forced to continue.
reviewWarningTimeDuration	Time before a reminder for the review definition task is sent.
sendVotingActionEmails	Indicates if an action email has to be sent to candidate users, users that are required to vote.

Variable	Description
smeUserExpression	The user expression for subject matter experts.
stakeholderUserExpression	The user expression for stakeholders.
stewardUserExpression	The user expression for stewards.
voteCompletionPercentage	Percentage of user candidates that is required to vote before the task is completed.
voteTimeoutDuration	Time before the voting process is forced to continue.
voteWarningTimeDuration	Time before a voting reminder is sent.



Edit the workflow configuration options

Warning For Collibra Data Privacy customers: Collibra Data Privacy comes with workflows for approving data privacy-specific assets. The Collibra DGC packaged approval workflows (Approval Process, Asset Approval Process and Simple Approval Process) should not be used to approve data privacy-specific assets. As such, ensure that your Collibra DGC approval workflows are not associated with data privacy-specific asset types, such as DPIA, PIA, Legitimate Interest Assessment and Compliance Self Assessment.

Prerequisites

You have a [global role](#) with the Workflow Administration or the System Administration [global permission](#), for example Sysadmin.

Steps

1. In the main menu, click , then  **Settings**.
 - » The [Collibra DGC settings page](#) opens.
2. Click **Workflows**.
 - » The [Workflows](#) settings page appears on the **Definitions** tab page.

3. Click the workflow that you want to configure.
4. Configure the available options:

To add a restriction rule:

The following example associates the asset type Business Rule with the workflow you selected in the previous step. For example, if you selected the Approval workflow, you will be able to use the Approval workflow to approve Business Rule assets.

Note When you change the scope of the workflow, the restriction rules are removed.

a. Click **Add**.

» A dialog box appears.

Asset Type	Restricted to community/domain, status
Business Term	(New)
Data Asset	> Business Analysts Community (Candidate)

Type: Business Rule

in domain community: New Policies & Business Rules

with status: Candidate

Cancel Save

b. Provide one or more **Types**.

In this example, you enter the **Business Rule** asset type.

Tip Select **Asset** to associate the workflow with all asset types.

- c. Click **domain** or **community**, and then provide the domains or communities to which the asset types belong.
- d. Select the status of the assets to which the workflow will apply. This setting is not applicable when you are applying the workflow to communities, domains or global.
- e. Click **Save**.
 - » The asset type is added to the **Applies To** list. The workflow applies to any assets of this asset type, with the status you selected, in the domains or communities you selected.

Note The restrictions use the logical OR function. In the example figure above, the workflow applies to Business Term assets that have the status New OR Data Asset assets that are in the Business Analysts Community and have the status Candidate.

To modify the Variables, Start Label, Start Event and Roles:	<ol style="list-style-type: none"> a. Click . b. Change the option. c. Click Save.
To modify the Other options:	Select or clear the check boxes.



View the running instances of a workflow

You can view the currently running instances of your workflows.

Prerequisites

You have a [global role](#) with the Workflow Administration or the System Administration [global permission](#), for example Sysadmin.

Steps

1. In the main menu, click , then  **Settings**.
 - » The [Collibra DGC settings page](#) opens.
2. Click **Workflows**.
 - » The [Workflows](#) settings page appears on the **Definitions** tab page.
3. In the tab pane, click **Workflows** → **Instances**.
 - » The overview of workflow instances appears.



For more information about the table, see [View running workflow instances](#).









Note You cannot view running workflows that contain only script tasks on the workflows instances page.

View running workflow instances

The workflows instances page displays details about running workflows that contain active user tasks. If the user task is part of a sub-process, you can see details about both the main process and the sub-process. You cannot see running workflows that contain only script tasks or that do not contain anymore user tasks.

You must have the Sysadmin global role or a global role that has at least the Workflow Administration global permission to access this page:

1. In the main menu, click , then  **Settings**.
 - » The [Collibra DGC settings page](#) opens.
2. Click **Workflows**.
 - » The [Workflows settings page](#) appears on the **Definitions** tab page.
3. In the tab pane, click **Workflows** → **Instances**.
 - » The overview of workflow instances appears.

Workflow	Resource	Task	Users	Starting Date	Error
Simple Approval Process	B3 RWA			10/5/16 10:56 AM	
Voting Sub Process	B3 RWA	Approval, Approval, Approval	 	10/5/16 10:56 AM	
Issue Management	Add definition for Accounts			10/4/16 2:59 PM	
Voting Sub Process	Add definition for Accounts	Approval, Approval, Approval, Approval...	 System User	10/4/16 3:26 PM	
Issue Management	gender on on boarding screen should be a seletikn not a drop down	Accept Review, Accept Review, Accept ...	 	2/6/16 11:25 PM	
Issue Management	add a drop selection gender for customer on boarding	Accept Review, Accept Review, Accept ...	 	2/6/16 7:00 PM	
Issue Management	DQ Issue: Customer Identifier validation Failed	Assign Reviewer	 Judy Clark	1/27/16 2:31 PM	wfCandidateUserCheckFailedOnStart.Params: [role Steward]
Issue Management	The customer data that's fed into the marketing database is not sufficient and of too low quality.			1/26/16 11:38 AM	
Voting Sub Process	The customer data that's fed into the marketing database is not sufficient and of too low quality.	Approval	 System User	10/4/16 3:48 PM	

Column	Description
Workflow	The name of the running workflow.
Resource	The resource the workflow is associated with. Click the resource name to go to the resource page.

Column	Description
Task	The name of the active user task.
Users	The users the active task is assigned to. Click the user name to go to the user profile page.
Starting Date	The start date of the process.
Error	Possible error message if the workflow instance encountered an error.
	Button to delete the workflow instance.

Back up workflows

You can create backups for individual workflows. This comes in handy if you have modified a packaged workflow definition and want to upgrade to a newer version of Collibra DGC that contains newer workflow definitions.

You must have the Sysadmin global role or a global role that has at least the Workflow Administration global permission to perform this action:



1. Open a workflow. See [View and edit workflows](#).
Below the diagram of the flow, you can find the raw workflow definition (XML).
2. Select all the raw workflow definition text and copy it.
You don't have to go into the edit mode.
3. Paste the text in a plain text file editor such as Notepad, Notepad++ or Vim and not an advanced text editor such as Word.
4. Save the text file as a new file on your local file system.

Delete workflows



You can delete workflows from the workflow definitions table or from the individual workflow definition pages.

You must have the Sysadmin global role or a global role that has at least the Workflow Administration global permission to perform this action.

Delete a workflow from the workflow definitions table

1. In the main menu, click , then  **Settings**.
 - » The [Collibra DGC settings page](#) opens.
2. In the tab pane, click **Workflows** → **Definitions**.
3. At the end of the row, click  to delete the workflow.

Delete a workflow from the workflow definition page

1. In the main menu, click , then  **Settings**.
 - » The [Collibra DGC settings page](#) opens.
2. In the tab pane, click **Workflows** → **Definitions**.
3. Click the workflow you want to delete.
4. At the right of the title bar, click  to delete the workflow.



Note Currently [running instances](#) of a deleted workflow continue to run until their completion. Use the [Collibra Command Line Interface](#) to [cancel workflow instances in bulk](#).

Restore a workflow

You can restore a workflow.

Prerequisites

You have a [global role](#) with the Workflow Administration or the System Administration [global permission](#), for example Sysadmin.

Steps

1. On your computer, open a workflow that you have previously backed up. See [Back up workflows](#).

2. Copy the XML text from the file.
If necessary, create a workflow in Eclipse - Flowable and then close all open windows.
3. In the Flowable Explorer pane, right-click your workflow and click **Open With** → **XML Editor**.
4. Click the **Source** tab.
5. Paste the copied XML text in the blank pane.
6. Click **Save**.
7. Close the XML editor.
8. In Collibra DGC, deploy your workflow, see [Deploy a workflow](#).

Users and groups settings page

On the **Users and groups settings** settings page of the [Collibra DGC settings](#), you can define users and what they are allowed to do in which part of Collibra Data Governance Center.

Collibra Data Governance Center uses a standard user-group-role model. This means that you can create groups and add users to them. Subsequently, you can assign roles to individual users or groups.

Assigning [roles](#) to [users](#) or [groups](#) is important:

- You provide or restrict [permissions](#) to do certain actions in Collibra DGC, such as editing asset attributes or deleting domains.
- You define the [responsibilities](#) of the user. These responsibilities are mostly used in workflows to assign tasks to the correct users.

You can manage users in the following ways:

- **Manually:** Create [users](#) and [groups](#) within Collibra DGC.
- **LDAP:** Connect Collibra DGC to your company's LDAP server to import users and groups.

Tab pages

The **Users and groups** settings page of the Collibra DGC settings is split in several tab pages:

Tab page	Description
Users	This tab page allows you to view and edit user accounts.
Groups	This tab page allows you to view and edit groups .

User and group management overview

For handling user management, Collibra Data Governance Center uses a standard user-group-role model. This means that you can create user groups and add users to them. Subsequently, you can assign roles to individual users or user groups.

Assigning [roles](#) to [users](#) or [user groups](#) is important:

- You provide or restrict [permissions](#) to do certain actions in Collibra DGC, such as editing asset attributes or deleting domains.
- You define the [responsibilities](#) of the user. These responsibilities are mostly used in workflows to assign tasks to the correct users.

You can manage users in the following ways:

- **Manually:** Create [users](#) and [user groups](#) within Collibra DGC.
- **LDAP:** Connect Collibra DGC to your company's LDAP server to import users and groups.

Users

A user is an individual who has access to Collibra Data Governance Center through a user account.

What the user can actually do in Collibra DGC, depends on the [license type](#), the [global roles](#) and the [responsibilities](#) assigned to the user.

Tip Users can be added to [user groups](#) to easily assign [roles](#) and responsibilities to multiple users at once.

Actions

- [Create](#) a user.
- [Open](#) a user's profile page.
- [Edit](#) a user.
- [Delete](#) a user.
- [Enable](#) a user.
- [Disable](#) a user.
- [Set or reset](#) a user's password.
- [Add](#) a user to a user group.
- [Remove](#) a user from a user group.
- [Assign](#) a resource role through a responsibility.
- [View](#) which users are currently logged in.

User type

The user type of a user depends on the [license type](#) that the administrator gave to the user.

User type	Description
Consumer	A consumer user is a user with a consumer license .
Author	An author user is a user with an author license .

User status

The user status of a user determines whether a user can log in or not.

User status	Description
Enabled	A user with the enabled status can log in to Collibra DGC. The license of this user counts towards the maximum number of licenses, if the user has the active password status.
Disabled	A user with the disabled status cannot log in to Collibra DGC. The license of this user does not count towards the maximum number of licenses.

Password status

Password status	Description
Active	A user with the active password status is a user that has a password.
Inactive	A user with the inactive password status is a user that does not have a password. This is typically a temporary status that only occurs right after creating a user. When a password is created for the user, the password status becomes active. It cannot revert to inactive.

Out-of-the-box users

Collibra DGC contains a number of out-of-the-box users. They are used to manage various aspects of Collibra DGC.

Default name	UUID	Purpose
SYSTEM_USER	"00000000-0000-0000-0000-000000900001";	The system user is used, amongst others, during the installation of Collibra DGC. It is hidden in Collibra DGC.
ADMIN_USER	"00000000-0000-0000-0000-000000900002";	The admin user is the default administrator used to configure Collibra DGC when it is installed.
COLLIBRIAN_USER	"00000000-0000-0000-0000-000000900000";	The Collibrian user is a user that can be used by Collibra, for example to provide support. It is hidden in Collibra DGC and should not be used for anything else.

Default name	UUID	Purpose
WORKFLOW_USER	"00000000-0000-0000-0000-000000900003";	The workflow user is used when changes are made through a workflow. It is hidden in Collibra DGC and should not be used for anything else.



Create a user

You can create one or more [users](#) in one go. At the same time, you can also choose the [license type](#) and add the user(s) to [user groups](#).

Prerequisites

You have a [global role](#) with the User Administration or the System Administration [global permission](#), for example Sysadmin.

Steps

- In the main menu, click , then  **Settings**.
 - » The [Collibra DGC settings page](#) opens.
- Click **Users and groups**.
 - » The [users and groups settings](#) appear on the **Users** tab page.
- Above the table, to the right, click **Add**.
 - » The **Create Users** dialog box appears.
- Enter the required information.

Field	Description
User details	Enter the user details of the new users.
Username*	Type the username of the user to sign in to Collibra Data Governance Center.

Field	Description
Email*	Type the email address to which Collibra DGC sends emails, such as the registration email and notifications.
First Name	Type the first name of the user.
Last name	Type the last name of the user.
	Click to remove a user.
Add another user	Click to add another user.
Add to user groups	<p>Enter user groups to add the new users to them. You can also add users to, or remove users from groups afterwards.</p> <div style="border: 1px solid #ccc; padding: 10px; background-color: #f9f9f9;"> <p>Note A user needs access to at least one of the basic Collibra DGC applications: Business Glossary, Reference Data, Data Stewardship or System administration. You can grant access by assigning one of the global roles that provide the required permissions to the users.</p> </div>
License type	Choose the license type for the new user(s).

Fields marked with * are mandatory

5. Click **Create**.

- » The newly created users are enabled, but inactive.
- » The newly created users receive an email to set a password. As an administrator, you can also manually [set or reset](#) it. When the password is set, the user is active.

Edit a user

You can edit a [user](#).

Prerequisites

You have a [global role](#) with the User Administration or the System Administration [global permission](#), for example Sysadmin.

Steps

1. [Open](#) a user's profile page.
2. Do one of the following:
 - [Edit](#) the account settings.
 - [Edit](#) the contact information.
 - [Edit](#) the email notifications.
 - [Edit](#) the user details.
 - [Edit](#) the license type of the user.

Set or reset a user password

You can set or reset the password of a [user](#):



- From the user table.
 - From the user's profile page.
- Do this to reset your own password.

Note You can only reset the password of users that were [created](#) manually.

Prerequisites

You have a [global role](#) with the User Administration or the System Administration [global permission](#), for example Sysadmin.

Set or reset a user password from the user table

1. In the main menu, click , then  **Settings**.
 - » The [Collibra DGC settings page](#) opens.
2. Click **Users and groups**.
 - » The [users and groups settings](#) appear on the **Users** tab page.

3. In the row of the user whose password you want to reset, click .
 - » The **Password Reset** dialog box appears.
4. Choose how you want to reset the password.

Option	Description
Email a link to the user.	Send an email to the user and let the user set a new password. <div style="border: 1px solid #ccc; padding: 5px; background-color: #f9f9f9;"> <p>Note The link to reset the password is by default valid for 60 minutes. You can edit the length of the validity in Collibra Console.</p> </div>
Generate a new password automatically.	Automatically generate a password.
Specify a new password.	Set a password yourself.

5. Click **Reset Password**.

Set or reset a user password from the user profile page

1. Click your avatar, then **Profile**.
 - » Your [profile page](#) appears.
2. In the upper-right corner, click **Reset Password**.
 - » An email is sent to the user to let the user set a new password.

Note The link to reset the password is by default valid for 60 minutes. You can [edit](#) the length of the validity in Collibra Console.

Enable a user

You can enable a [user](#).





Note

- You can only enable users if they were [created](#) manually.
- Newly created users are enabled by default.

Prerequisites

You have a [global role](#) with the User Administration or the System Administration [global permission](#), for example Sysadmin.

Steps

1. In the main menu, click , then  **Settings**.
 - » The [Collibra DGC settings page](#) opens.
2. Click **Users and groups**.
 - » The [users and groups settings](#) appear on the **Users** tab page.
3. In the row of the user that you want to enable, click .
 - » The user account is enabled.
 - » The icon changes into a green .

Disable a user





You can disable a [user](#).

Note You can only disable users if they were [created](#) manually.

Prerequisites

You have a [global role](#) with the User Administration or the System Administration [global permission](#), for example Sysadmin.

Steps

1. In the main menu, click , then  **Settings**.
 - » The [Collibra DGC settings page](#) opens.
2. Click **Users and groups**.
 - » The [users and groups settings](#) appear on the **Users** tab page.
3. In the row of the user that you want to enable, click .
 - » The user account is disabled.
 - » The icon changes into a green .



Delete a user

You can delete one or more [users](#) in one go.

Prerequisites

You have a [global role](#) with the User Administration or the System Administration [global permission](#), for example Sysadmin.

Steps

1. In the main menu, click , then  **Settings**.
 - » The [Collibra DGC settings page](#) opens.
2. Click **Users and groups**.
 - » The [users and groups settings](#) appear on the **Users** tab page.
3. Do one of the following:

If you want to...	Follow these steps
Delete a single user	<ol style="list-style-type: none"> a. In the row of the user that you want to delete, click . » The Delete user dialog box appears. b. Click Delete user.
Delete more than one user	<ol style="list-style-type: none"> a. Select the check boxes in front of the users that you want to delete. b. In the action toolbar, click Delete. <ul style="list-style-type: none"> » The Delete <number> users dialog box appears. c. Click Delete <number> users.

- » One or more users are deleted.
- » If a deleted user posted any comments, those comments remain in the system but without an associated name.





Export user table as a CSV file

You can export the information in the [user](#) table as a CSV file.

Prerequisites

You have a [global role](#) with the User Administration or the System Administration [global permission](#), for example Sysadmin.

Steps

1. In the main menu, click , then  **Settings**.
 - » The [Collibra DGC settings page](#) opens.
2. In the tab pane, click **Users**.
 - » The user table appears.
3. Above the table, to the right, click .
 - » The **Export users** activity starts.
4. When the **Export users** activity is finished, you can download the CSV file:
 - a. In the main menu, click , then **Show more**.
 - » Your [profile page](#) opens on the **Activities** tab page.
 - b. In the **Results** column of the **Export users** activity, click **Results**.
 - » Depending on your browser and browser settings, the files are downloaded to a default location or a dialog box appears to specify the location for the downloads.

Example

This is an example of the user information that is exported:

- User ID
- Password status (**activated** column)
- User status (**enabled** column)
- Username
- Email address
- First name
- Last name
- Gender
- Default language
- Last login time

exporta6d82c651da94d3181517a2e05de8df1					
id	activated	enabled	username	emailAddress	firstName
00000000-0000-0000-0000-000000900002	TRUE	TRUE	Admin	solution-team@collibra.com	Admin
0b42659d-ebc7-4171-b0d8-8fc18b8751da	TRUE	TRUE	john	john.fisher@collibra.com	John
1c4190f2-23a0-410c-a4e1-e1ea979dc67a	TRUE	TRUE	otg-api	rafael.ugolini@collibra.com	OTG
2086de3e-0dbf-44e9-b02b-a2565e623cd4	TRUE	TRUE	mary	mary.smith@collibra.com	Mary
23ccaf2b-7e25-42ce-89ce-9dc3d743bace	TRUE	TRUE	cliff	cliff.chopra@collibra.com	Cliff
35f55a00-7331-49d0-aa1b-43e4cbeb2d6c	TRUE	TRUE	joanna	joanna.zhou@collibra.com	Joanna
45b944df-b758-4826-b1b7-14351ca21a05	TRUE	TRUE	william	william.parker@collibra.com	William
5dd073c3-03ee-44e8-b0c4-61ba461236a4	TRUE	TRUE	eliza	eliza.arquette@collibra.com	Eliza
9693d5ce-9fb4-4e97-b46e-7218526eda14	TRUE	TRUE	DataLakeAdmin	datalake@collibra.com	DataLake
b0ffb1f5-f1aa-41e9-9815-494f45516932	TRUE	TRUE	dora	dora.portman@collibra.com	Dora
dfa71da4-fa9d-462c-87d7-52bec5ad207b	TRUE	TRUE	Gloria	gloria@collibra.com	Gloria
ec0162b4-f062-46f9-bbf8-22ff684916a6	TRUE	TRUE	preston	preston.sterling@collibra.com	Preston



View users that are logged in

As an administrator, you can view which [users](#) are currently logged in.

Prerequisites

You have a [global role](#) with the User Administration or the System Administration [global permission](#), for example Sysadmin.

Steps

1. In the main menu, click , then  **Settings**.
 - » The [Collibra DGC settings page](#) opens.
2. Click **Users and groups**.
 - » The [users and groups settings](#) appear on the **Users** tab page.
3. If required, add the column **Online**.
 - a. In the content toolbar, click  → **Columns** → **Currently logged in**.
 - » The **Currently logged in** column appears.

Groups

A group is a logical collection of [users](#).

The main purpose of groups is to facilitate assigning [roles](#) and [responsibilities](#). When a group is assigned a [resource role](#), the users in the group receive the resource roles and their [permissions](#).

Managing groups

There are several options for managing groups. However, you can only use one of the options below. It is not possible to combine them.

- Manage groups in [LDAP](#), using **Group field** mapping.
 - Prerequisite: You have configured the **Group field** setting in the user attributes to assign groups.

- If there are manually created groups in Collibra Data Governance Center, they are removed before the LDAP-managed groups are created.
- No synchronization is required for this option to work.
- Manage groups in Collibra DGC.
 - Prerequisite: You have not configured the **Group field** setting in Collibra Console in the user attribute settings.
 - Groups are managed directly in Collibra DGC. Creating groups and assigning users to the groups is done within Collibra DGC.
 - No synchronization is required for this option to work.

Out-of-the-box groups

Collibra DGC contains a number of out-of-the-box groups. They are used to manage various aspects of Collibra DGC.

Default name	UUID	Purpose
EVERYONE_GROUP	"00000000-0000-0000-0000-000001000001";	The Everyone group contains all users and is mainly used to manage view permissions . It is hidden in Collibra DGC and should not be used for anything else.
USERS_GROUP	"00000000-0000-0000-0000-000001000002";	The Users group contains all users and can be used for actions that affect all users. It is hidden in Collibra DGC.

Default name	UUID	Purpose
GROUP_DATA_CUSTODIANS	"00000000-0000-0000-0000-000001000003";	<p>The Data Custodians group is meant for users with the Data Custodian resource role and can be used for actions that affect all such users.</p> <div style="border: 1px solid #ccc; padding: 10px; margin-top: 10px;"> <p>Note When users are assigned the Data Custodian resource role for a resource, they are not automatically added to the Data Custodians group; however, you can manually add them to the group.</p> </div>

User group page

The user group page contains relevant information about that [user group](#).

The view bar contains some basic information about the user group, such as the name and the number of members.

The group page contains the following tab pages:

Tab page	Description
Overview	<p>The overview page contains general information such as the name and the number of members.</p> <p>It also contains a table containing the members of the user group, and allows you to add users to or remove users from the groups.</p>
Responsibilities	<p>The responsibilities page contains the responsibilities that are assigned to the user group.</p>



Create a user group

You can create a [user group](#).

Prerequisites

You have a [global role](#) with the User Administration or the System Administration [global permission](#), for example Sysadmin.

Steps

1. In the main menu, click , then  **Settings**.
 - » The [Collibra DGC settings page](#) opens.
2. Click **Users and groups**.
 - » The [users and groups settings](#) appear on the **Users** tab page.
3. In the tab pane, click **Users** → **Groups**.
 - » The user group table appears.
4. Above the table, to the right, click **Add**.
 - » The **Create groups** dialog box appears.
5. Enter the required information.

Field	Description
Name	The names of the new user groups. <div style="border: 1px solid #ccc; padding: 5px; margin-top: 10px;"> <p>Tip You can create multiple user groups in one go. To do this, press <code>Enter</code> after typing a value and then type the next. User group names have to be globally unique. If you type a name that already exists, it will appear in strike-through style.</p> </div>

6. Click **Save**.

Open user group page



You can open the [user group page](#) of a user group:

- From the settings.
- From the profile page of a member.

Prerequisites

You have a [global role](#) with the User Administration or the System Administration [global permission](#), for example Sysadmin.

Open a user group page from the settings

1. In the main menu, click , then  **Settings**.
 - » The [Collibra DGC settings page](#) opens.
2. Click **Users and groups**.
 - » The [users and groups settings](#) appear on the **Users** tab page.
3. In the tab pane, click **Users** → **Groups**.
 - » The user group table appears.
4. Click a group name.

Open a user group page from the profile page of a member

1. Click your avatar, then **Profile**.
 - » Your [profile page](#) appears.
2. In the tab pane, click **Groups**.
3. Click the name of a user group.



Edit a user group

You can edit a [user group](#).

Prerequisites

You have a [global role](#) with the User Administration or the System Administration [global permission](#), for example Sysadmin.

Steps

1. In the main menu, click , then  **Settings**.
 - » The [Collibra DGC settings page](#) opens.
2. Click **Users and groups**.
 - » The [users and groups settings](#) appear on the **Users** tab page.
3. In the tab pane, click **Users** → **Groups**.
 - » The user group table appears.
 - » The user group table appears.
4. Double-click a cell.
5. Make the necessary changes.
6. Click  .

Add a user to a user group



You can add a [user](#) to a [user group](#):

- While [creating](#) one or more users.
- From the user table.
Do this if you want to add a user to one or more user groups.
- From the user group page.
Do this if you want to add multiple users to a single user group.
- From the user's profile page.

Prerequisites

You have a [global role](#) with the User Administration or the System Administration [global permission](#), for example Sysadmin.

Add a user to a user group from the user table

1. In the main menu, click , then  **Settings**.
 - » The [Collibra DGC settings page](#) opens.
2. Click **Users and groups**.
 - » The [users and groups settings](#) appear on the **Users** tab page.

3. Do one of the following:
 - Double-click a cell in the **Groups** column.
 - Hover your mouse over a cell in the **Groups** column and click .
4. Click in the field and start typing the name of the group.
5. Select the group from the suggestions.
6. If required, select **Apply to visible rows**.
This will add all visible users to the groups.

Tip You can [filter](#) the columns first to add a selection of users to the group.

7. Click .

Add a user to a user group from the user group page

1. [Open](#) a user group page.
2. Above the table, to the right, click **Add**.
 - » The **Add to group** dialog box appears.
3. Enter the required information.

Field	Description
Users	Choose one or more users.

4. Click **Add**.
 - » The users are added to the user group and the users now appear in the table.

Add a user to a user group from the profile page

1. Click your avatar, then **Profile**.
 - » Your [profile page](#) appears.
2. In the tab pane, click **Groups**.
3. Above the table, to the right, click **Add**.
 - » The **Add to groups** dialog box appears.
4. Enter the required information.

Field	Description
Groups	Choose one or more user groups.

5. Click **Add**.

» The user is added to the user groups and the groups now appears in the table.

Remove a user from user group





You can remove a [user](#) from a [user group](#):

- By [deleting](#) a user.
- From the user table.
Do this if you want to add a user to one or more user groups.
- From the user group page.
Do this if you want to add multiple users to a single user group.
- From the user's profile page.

Prerequisites

You have a [global role](#) with the User Administration or the System Administration [global permission](#), for example Sysadmin.

Remove a user from a user group from the user table

1. In the main menu, click , then  **Settings**.
 - » The [Collibra DGC settings page](#) opens.
2. Click **Users and groups**.
 - » The [users and groups settings](#) appear on the **Users** tab page.
3. Do one of the following:
 - Double-click a cell in the **Groups** column.
 - Hover the mouse pointer over a cell in the **Groups** column and click .
4. In the user group name, click .
5. If required, select **Apply to visible rows**.
This will add all visible users to the groups.

Tip You can [filter](#) the columns first to add a selection of users to the group.

6. When you have added the groups, click .

Remove a user from a user group from the user group page

1. [Open](#) a user group page.
2. Do one of the following:

If you want to...	Follow these steps
Remove a single user from user group	<ol style="list-style-type: none"> a. In the row of the user that you want to remove from the group, click  . » The Remove user from group dialog box appears.
Remove more than one user from the user group	<ol style="list-style-type: none"> a. Select the check boxes in front of the groups from which you want to remove the user. b. In the action toolbar, click Remove. » The Remove users from group dialog box appears.

3. Click **Remove <number of selected users> users**.

Remove a user from a user group from the profile page

1. Click your avatar, then **Profile**.
 - » Your [profile page](#) appears.
2. In the tab pane, click **Groups**.
3. Do one of the following:

If you want to...	Follow these steps
Remove a user from a single user group	<ol style="list-style-type: none"> a. In the row of the group from which you want to remove the user, click  . » The Remove from group dialog box appears.
Remove a user from more than one user group	<ol style="list-style-type: none"> a. Select the check boxes in front of the groups from which you want to remove the user. b. In the action toolbar, click Remove. » The Remove from group dialog box appears.

4. Click **Remove**.



Delete a user group

You can delete one or more [user groups](#).

Prerequisites

You have a [global role](#) with the User Administration or the System Administration [global permission](#), for example Sysadmin.

Steps

1. In the main menu, click , then  **Settings**.
 - » The [Collibra DGC settings page](#) opens.
2. Click **Users and groups**.
 - » The [users and groups settings](#) appear on the **Users** tab page.
3. In the tab pane, click **Users** → **Groups**.
 - » The user group table appears.
4. Do one of the following:

If you want to...	Follow these steps
Delete a single group	<ol style="list-style-type: none"> a. In the row of the group that you want to delete, click  . <ul style="list-style-type: none"> » The Delete group dialog box appears. b. Click Delete group.
Delete one or more groups	<ol style="list-style-type: none"> a. Select the check boxes in front of the groups that you want to delete. b. In the action toolbar, click Delete. <ul style="list-style-type: none"> » The Delete <number> groups dialog box appears. c. Click Delete <number> groups.



LDAP user and group management

The Collibra Console administrator can integrate Collibra Data Governance Center with your company's LDAP servers. This administrator can synchronize user data as well as group-related information. When LDAP is configured, authentication (credential checking) is done directly on the LDAP server(s).

To synchronize with an LDAP server, the LDAP fields have to be mapped to the corresponding Collibra DGC fields and the LDAP server has to be configured correctly.

All the fields that are mapped to an LDAP user attribute are read only in Collibra DGC. You cannot change them in the UI.

You can recognize LDAP users

- by the LDAP column in the user table.
- on the user's profile page.
- in the user table, by the absent  (reset password) and  (enabled/disabled) user icons.

In the next sections, you can find how to use LDAP in Collibra DGC.

LDAP synchronization

Synchronization is the process of importing all LDAP data in Collibra Data Governance Center.

Users can be synchronized in the following ways:

- Automatically: You can configure a CRON job to synchronize the Collibra DGC users with your LDAP.
- Manually: You can [synchronize](#) LDAP manually.

Individual user data is synchronized every time a user signs in to Collibra DGC. If the user is authenticated through LDAP, the user data is synchronized with Collibra DGC. If the product identifies the user as deleted from the LDAP server, the user is disabled in Collibra DGC and access is denied.

Tip To set up the LDAP connection correctly, ensure that you know how your LDAP servers work and how they are structured, or ask your LDAP IT team for help



Synchronize LDAP users manually

You can manually synchronize your [LDAP](#) users to Collibra Data Governance Center manually.



Prerequisites

You have a [global role](#) with the User Administration or the System Administration [global permission](#), for example Sysadmin.

Synchronize LDAP users from the **Settings** page

1. In the main menu, click , then  **Settings**.
 - » The [Collibra DGC settings page](#) opens.
2. Click **General**.
 - » The [general settings](#) appear on the **Activities** tab page.
3. Click **Synchronize with LDAP**.
 - » The LDAP users are displayed in the table.

Synchronize LDAP users from the **Users** or **Groups** page

1. In the main menu, click , then  **Settings**.
 - » The [Collibra DGC settings page](#) opens.
2. Do one of the following:
 - In the tab pane, click **Users**.
 - » The user table appears.
 - In the tab pane, click **Users** → **Groups**.
 - » The user group table appears.
3. Above the table, click **Synchronize LDAP**.
 - » The LDAP users are displayed in the table.

LDAP FAQ

What if the connection between Collibra DGC and the LDAP server is lost?

LDAP users cannot sign in to Collibra DGC anymore. LDAP users who were logged in before losing the LDAP connection can continue working until their HTTP session is closed. When the LDAP synchronization job is triggered manually or automatically through scheduling, a `javax.naming.CommunicationException` is thrown and displayed in the logs.

What happens if a mapped field of an LDAP user cannot be found for a certain entry on the LDAP server during the synchronization?

The field remains empty when the user is imported in the application. However, both the username and email address are mandatory in Collibra DGC. If either field is not mapped in the configuration, LDAP cannot be enabled. Also, when searching for users on the LDAP server, a filter is used to make sure that only users with a username and email address are returned.

Are there any mandatory fields to map?

Yes. You have to specify at least a mapped field for the **username** and **email** fields. A user who does not have both mapped field attributes is ignored during the synchronization.

I'm seeing a lot of connection problems during the synchronization of users and there are no users visible in Collibra DGC after synchronizing. What could be the problem?

First check if the URL and credentials to connect to the LDAP servers are correct. If they are, but the problem persists, it could be related to the paging.

Paging is only possible if your LDAP server supports it. It also requires the connection to remain open during the synchronization process, to keep track of which page is to be processed next.

Paging is enabled by default and can be disabled by entering '0' in the **User page size** field.

Is the synchronization job really necessary?

No. If you disable the synchronization job, users can still be authenticated in the application. Each time the user logs in, personal information is updated and reflected in Collibra DGC. However, a user's personal information is not visible until the first sign-in to the application. This way the user is not known yet to the application. You also need the synchronization job to enable Groups from LDAP. These are only synchronized in the job,

unless you have mapped the groups as an attribute of the user. Then the groups will be taken in on the first encounter as the group of a user who is signing in.

Profile page

The profile page of a user contains all relevant information about that user.

As a user, you can only open your own profile page. As an administrator, you can also open other users' profile page.

The view bar contains some basic information about the user, such as the name, license type, required license type and email address.

The profile page contains the following tab pages:

Tab page	Description
Overview	The overview page contains general information such as the user's account information, mail notification settings and contact information.
Groups	The groups page contains the user groups of which the user is a member, and allows you to add the user to or remove the user from groups.
Responsibilities	The responsibilities page contains the responsibilities that are assigned to the user.
History	The history page contains the history of the user's actions.
Activities	The activities pages contains the list of your activities .
Mentions	The mentions page contains a list of all comments in which you are mentioned.

Open a profile page

As a regular user, you can open your own profile page. Administrators can open everybody's profile page.

Prerequisites



If you want to open the profile page of another user, you have a [global role](#) with the User Administration or the System Administration [global permission](#), for example Sysadmin.

Open your own profile page

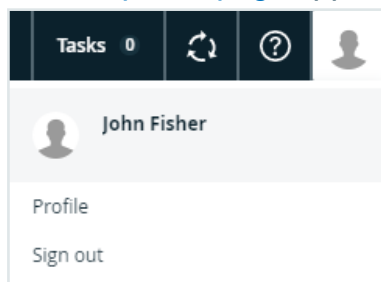
1. Click your avatar, then **Profile**.
 - » Your [profile page](#) appears.



Open another user's profile page

1. In the main menu, click , then  **Settings**.
 - » The [Collibra DGC settings page](#) opens.
2. Click **Users and groups**.
 - » The [users and groups settings](#) appear on the **Users** tab page.
3. Click the username of the user whose profile you want to open.

Edit user details

You can edit your own profile such as the application language, email notifications and contact email address on your [profile page](#). You can also reset your password, you receive instructions to do so by email.

Prerequisites

If you want to edit the user details of another user, you have a [global role](#) with the User Administration or the System Administration [global permission](#), for example Sysadmin.

Steps

1. Click your avatar, then **Profile**.
 - » Your [profile page](#) appears.
2. In the upper-right corner, click **Edit**.
 - » The **Edit** dialog box appears.
3. Enter the required information.

Field	Description
First name	Enter the first name of the user.
Last name	Enter the last name of the user.
Email	Enter the email address on which the user receives all communication from Collibra DGC, such as the registration mail and notifications.
License type	Choose the license type of the user.

4. Click **Save**.

Edit the user account settings

As a regular user, you can edit the settings of your own user account on your [profile page](#). As an administrator, you can also edit other users' settings.

Prerequisites

If you want to edit the user account settings of another user, you have a [global role](#) with the User Administration or the System Administration [global permission](#), for example Sysadmin.

Steps

1. Click your avatar, then **Profile**.
 - » Your [profile page](#) appears.
2. In the **Account** section, click  .

3. Enter the required information.

Field	Description
Username	Enter the username. You need administrator permissions to edit the username.
Application Language	Choose the interface language . As an administrator, you can add or edit interface languages .

4. Click **Save**.

Edit the contact information

As a regular user, you can edit contact information of your own user account on your [profile page](#). As an administrator, you can also edit other users' contact information.

Note You can also add new contact information.

Prerequisites

If you want to edit the contact information of another user, you have a [global role](#) with the User Administration or the System Administration [global permission](#), for example Sysadmin.



Edit contact information from a profile page

1. Click your avatar, then **Profile**.
 - » Your [profile page](#) appears.
2. Do one of the following:
 - In the **Contact** section, click  .
Do this to edit the existing fields.
 - In the **Contact** section, click **Add**.
Do this to add a new field, or edit the existing fields.

Note If you edit the email address, a notification email is sent to the old email address.

3. Edit the contact information.
4. Click **Save**.

Edit contact information from the user table

1. In the main menu, click , then  **Settings**.
 - » The [Collibra DGC settings page](#) opens.
2. Click **Users and groups**.
 - » The [users and groups settings](#) appear on the **Users** tab page.
3. Do one of the following:
 - Double-click a cell in the **E-mail** column.
 - Hover your mouse over a cell in the **E-mail** column and click .

Note If you edit the email address, a notification email is sent to the old email address.

4. Click in the field and type the new email address.
5. Click .

Edit the email notification settings

You can edit the email notification settings for your own user account. As an administrator, you can also edit other users' notification settings.

If you enable notifications, you will be notified via email whenever changes are made to assets for which you have been assigned a responsibility.

Note Only the 20 most recent changes for a given asset are shown in the notification email.

Prerequisites

If you want to edit the email notification settings of another user, you have a [global role](#) with the User Administration or the System Administration [global permission](#), for example Sysadmin.

Steps

1. Click your avatar, then **Profile**.
 - » Your [profile page](#) appears.
2. In the **Notifications** section, click .
3. Select or clear the necessary check boxes.

Field	Explanation
Notify me of content updates	Specify whether or not you want to receive email notifications. If you select this option, email notifications will be sent to the email address shown in the Contact section of your Profile page, at the specified frequency.
Days of the week	Receive email notifications only on the days you specify.
Monthly	Receive a summary email once a month.

4. Click **Save**.

Edit the maintenance announcement settings

You can edit the maintenance announcement settings on your [profile page](#).

If you enable maintenance announcements, you receive notifications in Collibra DGC about scheduled maintenance.

Prerequisites

Usage statistics are enabled. Contact [Collibra support](#) if this is not the case.

Steps

1. Click your avatar, then **Profile**.
 - » Your [profile page](#) appears.
2. In the **Scheduled Maintenance Notifications** section, click .
3. Select or clear the check box.
4. Click **Save**.

Edit a user's license type

As an administrator, you can edit a user's license type via their [profile page](#) or **Users** tab page.



Prerequisites

If you want to edit the license type of another user, you have a [global role](#) with the User Administration or the System Administration [global permission](#), for example Sysadmin.

Edit a user's license type via the profile page

1. Click your avatar, then **Profile**.
 - » Your [profile page](#) appears.
2. In the upper-right corner, click **Edit**.
 - » The **Edit** dialog box appears.
3. In the **License** field, choose the license type of the user.
4. Click **Save**.

Edit one or more users' license type via the Users tab page



1. In the main menu, click , then  **Settings**.
 - » The [Collibra DGC settings page](#) opens.
2. In the tab pane, click **Users**.
 - » The user table appears.
3. If required, [add the License column](#).
4. [Edit the cells](#) in the **License** column.

User licenses

A user license is the overall authorization for a [user](#) to perform certain actions in Collibra DGC. What a user can actually do in Collibra DGC depends on the [global roles](#) and the [responsibilities](#) of the user.

License types

The license type defines the actions a user is authorized to carry out. There are currently two license types:

License type	Description
Consumer	<p>A Consumer license is the minimum license type. It allows a user to:</p> <ul style="list-style-type: none"> • View resources. • Collaborate using social features such as comments, tags and ratings. • Use workflows. <div style="background-color: #f0f0f0; padding: 5px; margin: 10px 0;"> <p>Note It does not allow users to create, edit or delete resources.</p> </div> <p>You can see which global and resource permissions require a Consumer license, in  Settings.</p>
Author	<p>An Author license is the maximum license type. It allows a user to perform all actions that require Consumer permissions, and create, view, edit and delete resources, such as:</p> <ul style="list-style-type: none"> • Create, edit and delete assets. • Create, edit and delete communities, domains and responsibilities. • Create and share (anyone's) application, community and domain views. • Create and share (anyone's) dashboards. • Bulk import assets through Excel, CSV or API (Connect). • Manage workflows. • Edit the operating model, for example create, edit and delete asset types. • Manage users, user groups, roles and permissions. <p>You can see which global and resource permissions require an Author license, in Collibra DGC  Settings.</p>

Users that have a [global role](#) with the System Administration global permission can [edit the license type of other users](#). If those users are [enabled](#) and have a global role with at least one Product Rights [global permission](#), they also occupy a license.

The maximum number of licenses of each type is defined in the [license file](#).

Warning If your organization occupies more licenses than the maximum (as stipulated in your contract and identified in the license file), your administrator will receive a warning, but all users will retain access to all Collibra DGC functionality, as determined by their roles and responsibilities. Occupying more licenses than the maximum may have financial and legal implications.

Access to Collibra Console does not require a license.

License usage

A User is a specific individual that you authorize to use the Collibra software, regardless of whether such individual is using the Collibra software at any given time. Each individual shall be assigned a unique User identification. Multiple individuals may not share the same User identification. In addition to all individual Users, all users of a non-human operated device shall be counted as User if such device has access to the Collibra software in accordance with User roles and responsibilities. Users are limited to the number set forth in the respective Order, and access to the Collibra software will be restricted to such number of Users through a license management key provided by Collibra. If a User no longer requires access to the Collibra software, you may deactivate that individual and you can designate a new individual as a User of the Collibra software without incurring additional fees.

Required license type

For each user, Collibra DGC calculates the required license type.

The required license type is:

- The license type that a user needs to carry out the actions available to the user via the roles and responsibilities that were assigned to the user.
- The maximum license type of any permission included in a global role or resource role of that user.

If none of the permissions require an Author license, the required license of the user is Consumer.

Tip You can [see](#) the required license type of all permissions in the  **Settings**. You can also see the required license types of all permissions and the packaged global roles and resource roles in the administration guide:

- [Permissions of the packaged global roles](#)
- [Permissions of the packaged resource roles](#)

Mismatches between required license type and given license type

Ideally, the given and required license types match. For example:

- A user with a Consumer license should only have roles and responsibilities that have Consumer permissions.
- A user with an Author license should have roles and responsibilities that have one or more Author permission.

However, a user may have responsibilities with permissions for which the user does not have the correct license type. For example, a user with a Consumer license has been assigned a responsibility that requires Author permissions.

Example

David English is a Data Engineer. He has a user account with a Consumer license, which allows him to consult Collibra Data Governance Center. He finds some errors and reports them to his colleagues. Because he has advanced knowledge on certain topics, the administrator assigns him the Subject Matter Expert resource role for the relevant communities. With that role, he can add, edit and remove attributes of the assets in the communities. However, the Subject Matter Expert resource role requires an Author license. As a consequence, his Consumer license is insufficient. His administrator should give him an Author license.

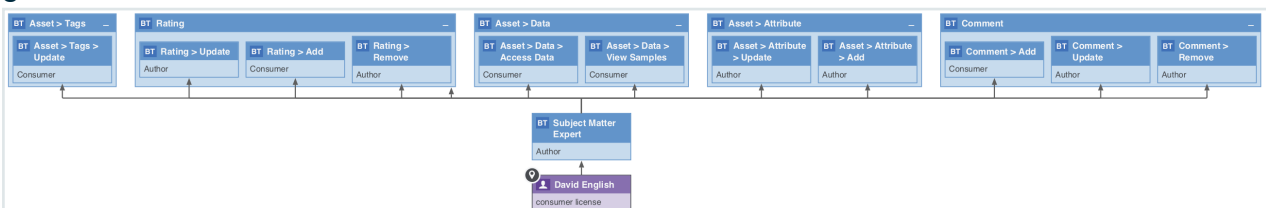

Warning Collibra DGC does not actively enforce the correct license type. Users with a Consumer license can still perform actions that require Author permissions, though they will see a warning message.

If there's a mismatch, consider one of the following:

- **Edit** the license type of the user.
- Remove the user from the responsibilities or **groups** that require a higher license type.

Actions

All users can see their own license type when they **open** their **profile page**.



An administrator can do the following:

- **View** the available number of licenses per license type.
- **View** and **give** a license to a user.

View used licenses

As an administrator, you can view how many **licenses** of each type are currently in use.

View used licenses in Collibra Data Governance Center

1. In the main menu, click , then  **Settings**.
 - » The **Collibra DGC settings page** opens.
2. Click **Users and groups**.
 - » The **users and groups settings** appear on the **Users** tab page.
 - » The number of licenses that are in use and the maximum number of licenses for each type are shown above the user table.

View used licenses in Collibra Console

1. Open Collibra Console.
 - » Collibra Console opens with the **Infrastructure** page.

2. Click an environment.
 - » The **Overview** page of the environment appears.
3. Click **License**.
 - » The **License** page appears, including the license usage information and the enabled products.

View and compare user license types



As a user, you can view your license type on the profile page. As an administrator, you can view the license type of any user on the user's profile page and in the user table.

Tip As an administrator, you can immediately edit the license type.

View user license type in the user profile

1. Click your avatar, then **Profile**.
 - » Your [profile page](#) appears.
 - » On the resource toolbar, below the username, you can see the user's license type.
 - » If the user's given license type does not match the user's required license type, the view bar will show the required license type.
2. If the user requires another license type, consider doing one of the following:
 - [Edit](#) the user's license type.
 - Remove the user from the [responsibilities](#) or [user groups](#) that require another license type.

View user license type in the user table

1. In the main menu, click , then  **Settings**.
 - » The [Collibra DGC settings page](#) opens.
2. Click **Users and groups**.
 - » The [users and groups settings](#) appear on the **Users** tab page.
3. If required, add the column **License type**.
 - a. In the content toolbar, click  → **Columns** → **License type**.
 - » The **License type** column appears.

4. If required, check if the user requires another license type.
 - a. If required, add the column **Required license type**.
 - i. In the content toolbar, click  → **Columns** → **License type**.
 - » The **License type** column appears.
 - b. Compare the values of the columns **License type** and **Required license type**.
 - c. If the values are not the same, consider doing one of the following:
 - [Edit](#) the license type of the user.
 - Remove the user from the [responsibilities](#) or [user groups](#) that require another license type.



View the permissions per license type

You can see which global and resource [permissions](#) require which [license type](#), in  **Settings**.

Tip You can also see the permissions of the packaged global roles and resource roles in the admin guide:

- [Permissions of the packaged global roles](#)
- [Permissions of the packaged resource roles](#)

Steps





1. In the main menu, click , then  **Settings**.
 - » The [Collibra DGC settings page](#) opens.
2. Click **Roles and permissions**.
 - » The [roles and permissions settings](#) appear on the **Roles** → **Global** tab page.
3. Do one of the following:
 - In the tab pane, click **Permissions** → **Global**, to view the global permissions and their required license type.
 - In the tab pane, click **Permissions** → **Resource**, to view the resource permissions and their required license type.
 - » The required license type is shown in the column **Required license**.

Edit user license type

As an administrator, you can edit the license type of a user in the following places:

- In the user table.
- On the user profile page.

Edit user license type in the user table

1. In the main menu, click , then  **Settings**.
 - » The [Collibra DGC settings page](#) opens.
2. Click **Users and groups**.
 - » The [users and groups settings](#) appear on the **Users** tab page.
3. If required, add the column **License type**.
 - a. In the content toolbar, click  → **Columns** → **License type**.
 - » The **License type** column appears.
4. Do one of the following:
 - Double-click a cell in the **License type** column.
 - Hover your mouse over a cell in the **License type** column and click .
5. Click in the field and enter the new license type.
6. If required, select **Apply to visible rows**.

This will edit the license type of all visible users.

Tip You can [filter](#) the columns first to edit the license type of a selection of users.

7. Click .

Edit user license type in the user profile

1. Click your avatar, then **Profile**.
 - » Your [profile page](#) appears.
 - » On the title bar, below the username, you can see the user's license type.
2. In the upper-right corner, click **Edit**.
 - » The **Edit** dialog box appears.

3. Enter the required information.

Field	Description
First name	Type the first name of the user.
Last name	Type the last name of the user.
Email	Type the email address on which the user receives all communication from Collibra DGC, such as the registration mail and notifications.
License type	Choose the license type of the user.

4. Click **Save**.

Collibra Data Governance Center license file

To be able to use Collibra Data Governance Center, you need a valid license file, named **collibra.license**, that you have to [upload](#) in Collibra Console.

Your organization's license file defines:

- The Collibra products and applications that your organization can use.
- The expiration date of the user licenses.
- The maximum number of users.

This license file also contains a signature string, to avoid tampering.

Example license

The following is an example of a Collibra DGC license file:

```
customer = Collibra
writerCount = 10
contributorCount = 0
readerCount = 50
apiUserCount = 0
maxAssets = 2147483647
maxWorkflows = 2147483647
product-connect = true
product-catalog = true
product-glossary = true
```

```
product-reference-data = true
product-helpdesk = true
product-policy = true
product-stewardship = true
product-data-dictionary = false
product-onthego-mobile = true
product-onthego-windows = true
expirationDate = 2100-12-31
guestAccess = true
Vqr27XTn0Swuax...
```

Maximum number of users per license type

The license file contains the maximum number of [user licenses](#) of each license type.

For each license type, Collibra Data Governance Center counts the number of enabled [users](#).

Note The `apiUserCount` parameter in the license file is no longer taken into account in Collibra DGC.

Applications

Collibra DGC consists of the following applications and external products.

Applications:

- Catalog (product-catalog)
- Business Glossary (product-glossary)
- Reference Data (product-reference-data)
- Data Helpdesk (product-helpdesk)
- Policy Manager (product-policy)
- Stewardship (product-stewardship)
- Data Dictionary (product-data-dictionary)

External products:

- Collibra Connect (product-connect)
- Collibra Everywhere for iOS (product-onthego-mobile)
- Collibra Everywhere for Windows (product-onthego-windows)

License violations

You can encounter the following license violations:

- **Invalid or no license file:** You have no license file or have tampered with it.
- **Expired:** Your license has passed the expiration date that was defined in the license file. When you are close to the expiration date of your license, every user with the Sysadmin role gets a notification message at the top of every page.

Note In Collibra Console, every user will see the license expiry message.

- **Author user limit exceeded:** Contact Collibra Support, at support@collibra.com, for further assistance.

Note This does not prevent you from creating new users, or restrict Collibra DGC in any other way. It is, however, a license violation, and may lead to legal action.

In case of license violations, all Collibra DGC users get an error message at the top of every page. You can only remove the error by taking one or more of the following actions:

- [Upload](#) a new, suited license file.
- [Disable](#) users.
- [Delete](#) users.

If there is no license file, an invalid license, or an expired license, Collibra DGC blocks all upgrades.

Services configuration

On the **Services configuration** settings page of the [Collibra DGC settings](#), you can edit settings that affect your entire platform. For example, you can edit the help menu and configure the search feature.

Note The services configuration in the Collibra DGC settings is the same as the DGC service settings that require the ADMIN role in Collibra Console. By default, you do not see this section. Contact [Collibra support](#) if you want to use this section.

The Collibra configuration includes the following options:

General settings

The general settings of Collibra Data Governance Center.

Setting	Description
Enable view rights	<ul style="list-style-type: none"> ✓ True (default): The view permissions feature is enabled. ✗ False: The view permissions feature is disabled.
Show target asset type above relation table	<ul style="list-style-type: none"> ✓ True (default): Show the asset type of the target asset in the title of relation tables on an asset page. The target asset can be either the head or the tail of the relation, depending on which asset page you have open. ✗ False: Hide the asset type of the target asset. <p>The default value is <code>true</code>.</p>
Refreshed Navigation	<ul style="list-style-type: none"> ✓ True: Use the new, refreshed navigation of the Collibra user interface. ✗ False (default): Use the classic navigation of the Collibra user interface.
Add Asset Grid link to menu	<ul style="list-style-type: none"> ✓ True: Add the link to Asset Grid in the main menu of your environment. ✗ False (default): The link to Asset Grid is not available in the main menu of your environment.

Help Menu

The configuration of the Help menu in Collibra Data Governance Center.

Setting	Description
Links	The list of links in the help menu.
Menu item name	The name of the menu item as it will appear in Collibra Data Governance Center's help menu.
Menu index	The position of the menu item in the help menu. The top position starts with the value 1.

Setting	Description
Menu URL	The target URL of the menu item.
Show admin only	<ul style="list-style-type: none"> ✓ True: The menu item is only visible to users with the Sysadmin role. ✗ False: The menu item is visible to every user.

Email configuration

The configuration of email notifications.

Note In a Collibra Data Intelligence Cloud environment, you cannot update the email server settings, such as host and port. For more information, see [Collibra Data Intelligence Cloud infrastructure](#).

Setting	Description
Default schedule (Requires restart)	<p>The Cron schedule to send emails only at specific times. With this, you can send emails in batches and avoid an overload of mails.</p> <p>Keep in mind that these emails are only workflow emails and have nothing to do with the notification schedule.</p> <p>If you create an invalid Cron pattern, Collibra Data Governance Center stops responding.</p>
Template map	The location of template emails.
From address (*)	<p>The email address used as the sender of all outgoing emails.</p> <p>Contact Collibra support to change the From address, see also Email configuration.</p>

Notifications

The configuration of notification emails to users.

Note These settings can be overridden for every user in the preferences.xml file.

Setting	Description
Notification days	<p>The days of the week on which Collibra DGC sends notifications. The days are represented by numbers from 1 to 7, where 1 represents Sunday.</p> <p>Per row you can add one day.</p>
Daily roles	The roles that receive notifications on the days defined in Notification days .
Enable monthly notifications	<ul style="list-style-type: none"> ✓ True: The users receive a monthly summary. ✗ False (default): The users do not receive a monthly summary.
Roles for monthly notifications	The roles that receive monthly notification emails. This is only relevant if Enable monthly notifications is ✓ True.
Setting	Description
Enable hyper-linking	<ul style="list-style-type: none"> ✓ True: Hyperlinks are created automatically. ✗ False (default): Hyperlinks are not created automatically. <p>For more information about automatic hyperlinks, see Hyperlinking.</p> <div style="border-left: 2px solid red; padding-left: 10px; margin-top: 10px;"> <p>Warning If you enable this setting, the performance of Collibra DGC can decrease.</p> </div>
Enable case sensitivity	<ul style="list-style-type: none"> ✓ True: Hyperlinks are case-sensitive. ✗ False (default): Hyperlinks are not case-sensitive. <div style="border-left: 2px solid gray; padding-left: 10px; margin-top: 10px;"> <p>Note If you edit this setting, you have to reindex Collibra DGC.</p> </div>
Excluded asset type IDs	<p>The list of asset types that are ignored by automatic hyperlinking. You can enter multiple asset type IDs, separated by commas.</p> <p>Excluding assets reduces the amount of hyperlinks, which improves performance.</p> <div style="border-left: 2px solid green; padding-left: 10px; margin-top: 10px;"> <p>Tip We recommend that you exclude technical asset types such as Column, Field, Table, Code Value and Code Set.</p> </div> <div style="border-left: 2px solid gray; padding-left: 10px; margin-top: 10px;"> <p>Note If you edit this setting, you have to reindex Collibra DGC.</p> </div>

Recommender configuration

The configuration of the recommender.

Setting	impacts	Description
Catalog recommender enabled	All recommendations	<ul style="list-style-type: none"> ✓ True (default): The "Data sets you might like" section is included on the Data Catalog Home page. This section shows data sets you might be interested in, as determined by the recommender, which takes into account your data sets and the data sets of similar users. ✗ False: The "Data sets you might like" section is not included on the Data Catalog Home page.
Data set recommender execution time	Recommendations of data sets to users	The schedule (CRON job) by which the data set recommender looks for recommended data sets for a user. By default the data set recommender does this every night.
Asset recommender execution time	Recommendations of business assets to data assets	The schedule (CRON job) by which the asset recommender looks for suggested relations between business assets and data sets.
Data set matcher execution time	Data set matcher	The schedule (CRON job) by which the data set matcher looks for similar data sets.
Data set similarity threshold	Data set matcher	<p>The amount of business assets that have to be related to two data sets before the data sets are considered to be similar.</p> <p>This percentage is expressed by a decimal where 1,00 equals 100%.</p> <p>Example If this value is 0.3 and at least 30% of the related business assets are related to both data sets, they are considered to be similar.</p>

Setting	impacts	Description
Duplicate schema threshold	Schema matcher	<p>The amount of assets that have to be related to both schemas before the schemas are considered to be similar.</p> <p>This percentage is expressed by a decimal where 1,00 equals 100%.</p>
Fuzzy vs exact matching strategy for business assets	Recommendations of business assets to data sets and of business assets to column assets	<p>The percentage that determines to what extent assets with a similar name become more important.</p> <p>The ranking in the search engine results always has an impact on the suggestion score. However, similarity between the asset names can also be taken into account. If you decrease this percentage, the ranking of the search results becomes more important for the suggestion score, while the similarity between the asset names becomes less important. If you increase the percentage, assets with similar names will receive a higher suggestion score.</p> <p>This percentage is expressed by a decimal where 1,00 equals 100%. You can enter a value greater than 1,00.</p>
Recommendation weights for data sets	Recommendations of data sets to users	<p>An ordered comma-separated list of values that define the importance of properties for recommendations. The order of the values reflects the importance of the value.</p> <p>This setting is only used for data set recommendations if your Collibra DGC does not yet have enough data for relevant results from the active recommendations algorithms.</p> <p>Possible values:</p> <ul style="list-style-type: none"> • <i>CERTIFIED</i>: Data sets that are certified are considered more relevant. • <i>POPULARITY</i>: The number of visits to the data set page.

Setting	impacts	Description
Active recommendation algorithms	Recommendations of data sets to users and of business assets to data sets	<p>A comma-separated list of algorithms that calculate recommendations. By default, all available algorithms are listed.</p> <p>Possible values:</p> <ul style="list-style-type: none"> • <i>BASELINE</i> • <i>USER_MEAN</i> • <i>IICF (Item-Item Collaborative Filtering)</i> • <i>SLOPE_ONE</i> • <i>WEIGHTED_SLOPE_ONE</i>
Data set elements threshold	Recommendations of data sets to users	<p>The maximum number of elements per data set that the recommender will use to train the model. The data set elements are taken randomly.</p> <p>Lowering this number can prevent out-of-memory issues but also impacts the accuracy of recommendations for large data sets.</p>

Warning If you create an invalid Cron pattern, Collibra Data Governance Center stops responding.

Search index configuration

The configuration of the search index.

Setting	Description
UI search appends wildcard	<ul style="list-style-type: none"> • ✓ True (default): A wildcard (asterisk) is automatically added to each search query. An asterisk is not added in the following exceptions: <ul style="list-style-type: none"> ◦ If the query contains a tilde (~). ◦ If the query ends with a quotation mark ("). <div style="border: 1px solid #ccc; padding: 5px; margin: 10px 0;"> <p>Note This applies only to queries via the user interface. A wildcard is not added automatically for REST API queries.</p> </div> • ✗ False: No wildcard is added to the search query.

Setting	Description
Maximum batch size	The amount of resources scanned in one go for the search query. The default value is 5,000. The maximum value is 30,000.
Maximum batch size for relations	Maximum batch size for relations reindex.
Stop words (Requires restart)	A list of stop words that are ignored as tokens for the index. The default list of English stop words includes: a, an, and, are, as, at, be, but, by, for, if, in, into, is, it, no, not, of, on, or, such, that, the, their, then, there, these, they, this, to, was, will, with If you choose not to create your own list of stop words, the default list applies. If you create your own list of stop words, you have to: <ol style="list-style-type: none"> 1. Reindex Collibra Data Governance Center. 2. Restart the environment to apply your changes. See Stop an environment and Start an environment.

Tokenizer

The configuration of the tokenizer of the indexing mechanism. If you edit these settings, you need to restart and [reindex](#) your environment.

Setting	Description
Type	The tokenizer that is used. Currently two tokenizers are supported: <ul style="list-style-type: none"> • Standard (default): This tokenizer uses the word break rules from the Unicode Text Segmentation algorithm, as specified in Unicode Standard Annex #29. • Character: This tokenizer sees words as groups of all alphanumeric characters together with a configurable list of extra characters. This can be used if you know for sure which characters should keep certain words together. For example, if you want to keep words with a dash (-) together, you have to add the dash in the allowedCharacters parameter.

Setting	Description
Parameter map	<p>The allowed characters if the Type is Character.</p> <ul style="list-style-type: none"> • Field key: This field has to contain <i>allowedCharacters</i>. • Field value: The concatenated list of characters that does not split strings into separate tokens. For example, the concatenated list '-' allows dashes and apostrophes in tokens.

Boosting

The configuration of the [boosting](#) function.

Setting	Description
Asset	The boost factor of assets.
Class Match	The boost factor of data classes.
Community	The boost factor of communities.
Domain	The boost factor of domains.
User	The boost factor of users.
User group	The boost factor of user groups.
Name	The boost factor of names.
Comment	The boost factor of comments.
Tag	The boost factor of tags.
Attribute boost map	<p>The boost factor of attribute types.</p> <ul style="list-style-type: none"> • Field key: The attribute type ID. • Field value: The boost factor of the attribute type.
Display exact match of name as first	<ul style="list-style-type: none"> • ✓ True (default): If the name of an asset is exactly the same as the search text, put it at the top of the search results regardless of boost factors. • ✗ False: Use the regular search order, taking into account boost factors.

Setting	Description
Asset boost map	<p>The boost factor of asset types.</p> <ul style="list-style-type: none"> • Field key: The asset type ID. • Field value: The boost factor of the asset type.
Partial exact match enabled	<p>Enables partial exact matching while searching for multi word phrases.</p> <ul style="list-style-type: none"> • ✓ True (default): For multi-word search text, the search engine considers the exact match percentage with the resource name, when ordering the results. <ul style="list-style-type: none"> Example You enter search text "scheduled maintenance". Two example assets are ordered as follows: <ol style="list-style-type: none"> a. An asset named "daily scheduled maintenance", as two of the three words (66%) match exactly. b. An asset named "daily scheduled maintenance revised", as two of the four words (50%) match exactly. • ✗ False: The exact match percentage is not taken into account in the score calculation.

Slow logs configuration

The configuration of the slow logs function.

Setting	Description
Indexing threshold	<p>The time limit, in milliseconds, after which an index query is logged in Elasticsearch.</p> <p>If the value is set to 0 (zero), all index queries are logged.</p> <p>Changes to this setting require a full reindex of your Collibra Data Intelligence Cloud environment.</p>
Fetching threshold	<p>The time limit, in milliseconds, after which a fetch query is logged in Elasticsearch.</p> <p>If the value is set to 0 (zero), all fetch queries are logged.</p> <p>Changes to this setting require a full reindex of your Collibra Data Intelligence Cloud environment.</p>

Statistics configuration

The configuration of statistics.

Setting	Description														
Buffer size	<p>The maximum amount of statistics entries that the buffer can contain before saving them in the database.</p> <p>The default value is <i>10</i>.</p>														
Buffer flush time	<p>The maximum amount of time in milliseconds to keep statistic entries in memory before saving them in the database.</p> <p>The default values is <i>10,000</i>.</p>														
Cron map	<p>List of statistics, listed by their Cron name, and a Cron interval.</p> <p>These are the default values:</p> <table border="1"> <thead> <tr> <th>Field key</th> <th>Field value</th> </tr> </thead> <tbody> <tr> <td>workflow-task</td> <td>0 59 23 * * ?</td> </tr> <tr> <td>active-users</td> <td>0 0/15 * * * ?</td> </tr> <tr> <td>term-count</td> <td>0 59 23 * * ?</td> </tr> <tr> <td>vocabulary-count</td> <td>0 59 23 * * ?</td> </tr> <tr> <td>page-hit</td> <td>0 0 * * * ?</td> </tr> <tr> <td>task-count</td> <td>0 0 * * * ?</td> </tr> </tbody> </table> <p>If you create an invalid Cron pattern, Colibra Data Governance Center stops responding.</p>	Field key	Field value	workflow-task	0 59 23 * * ?	active-users	0 0/15 * * * ?	term-count	0 59 23 * * ?	vocabulary-count	0 59 23 * * ?	page-hit	0 0 * * * ?	task-count	0 0 * * * ?
Field key	Field value														
workflow-task	0 59 23 * * ?														
active-users	0 0/15 * * * ?														
term-count	0 59 23 * * ?														
vocabulary-count	0 59 23 * * ?														
page-hit	0 0 * * * ?														
task-count	0 0 * * * ?														

Import configuration

The configuration for imports.

Setting	Description
Rebuild hyperlinks after import	<ul style="list-style-type: none"> ✓ True (default): Automatically rebuild the hyperlinks after an import. ✗ False: Do not rebuild the hyperlinks after an import.
Asset responsibilities support	<ul style="list-style-type: none"> ✓ True: Enable importing responsibilities at asset level. ✗ False (default): Disable importing responsibilities at asset level. <div style="border-left: 2px solid red; padding-left: 10px; margin-top: 10px;"> <p>Warning Setting specific responsibilities on a large number of resources will affect the performance and stability of the system.</p> </div>
Temp files storage	<p>The location of the temporary files used by the import job.</p> <p>The default value is <i>FILE</i>.</p>

Excel import configuration

The configuration of Excel import.

Setting	Description
The default CSV separator character	The default separator character of the CSV fields for complex relations.
The default CSV quote character	The default quote character of the CSV fields for complex relations.
Number of rows per chunk of data	<p>When importing views, the database is called repeatedly, each time importing a chunk of data from the import file. This option defines how many rows each chunk of data can contain.</p> <p>Lower values reduce the burden on memory. Higher values require more memory, but may slightly increase the speed of the export.</p> <p>The default value is 5,000.</p>

Excel export configuration

The configuration of Excel export.

Setting	Description
The default CSV separator character	The default separator character of the CSV fields for complex relations.
The default CSV quote character	The default quote character of the CSV fields for complex relations.
Number of rows per chunk of data	<p>When exporting views, the database is called repeatedly, each time fetching a chunk of data to build the export file. This option defines how many rows each chunk of data can contain.</p> <p>Lower values reduce the burden on memory. Higher values require more memory, but may slightly increase the speed of the export.</p> <p>The default value is 5,000.</p>

CSV export configuration

The configuration of CSV export.

Setting	Description
Always use quotes	<ul style="list-style-type: none"> ✓ True: Use quotes for every cell in the CSV. ✗ False (default): Only use quotes when necessary.
Number of rows per chunk of data	<p>When exporting views, the database is called repeatedly, each time fetching a chunk of data to build the export file. This option defines how many rows each chunk of data can contain.</p> <p>Lower values reduce the burden on memory. Higher values require more memory, but may slightly increase the speed of the export.</p> <p>The default value is 5,000.</p>

API call logging

The configuration of the API call logging.

Setting	Description
Enabled	<ul style="list-style-type: none"> ✓ True: API call logging is enabled. ✗ False (default): API call logging is disabled.
Pattern duration list	The list of methods and a corresponding minimum duration time. The minimum duration time is the minimum time before the method is stored in the database.
Minimum duration	The time in milliseconds that an API call must last before it is logged.
Method pattern	The method that you want to log in the database. For each pattern that you want to log, you have to add a new pattern.

Security configuration

The configuration of security.

Setting	Description
X-Frame options (Requires restart)	The content of the HTTP-header <code>X-Frame-Options</code> . This is set on all rendered pages and is used to avoid clickjacking attacks . By default, only pages with the same origin can use the rendered pages in a frame.
Limit user sessions	<ul style="list-style-type: none"> ✓ True: A user can only open one session. ✗ False (default): A user can open multiple sessions.
Office research guest access	<ul style="list-style-type: none"> ✓ True: The Office research integration is always allowed guest access via REST, regardless of the general Guest access setting. ✗ False (default): The general Guest access setting is kept. <div style="border: 1px solid #ccc; padding: 10px; margin-top: 10px;"> <p>Note Currently, The Office research integration is only available when Collibra Data Governance Center is publicly available, which is why this override setting is necessary.</p> </div>

Setting	Description
Prevent advanced html features in text dashboard	<p>Text widgets can contain full HTML. However, this means an attacker could potentially execute an XSS attack by injecting malicious HTML. For more information, see the Troubleshooting section.</p> <ul style="list-style-type: none"> ✓ True: Potentially dangerous HTML elements are removed from text attributes when you save the text field. ✗ False (default): No HTML elements are removed from text attributes when you save the text field. <div style="background-color: #f0f0f0; padding: 10px; margin-top: 10px;"> <p>Note If you enable this setting, the following HTML elements are deleted when you save:</p> <ul style="list-style-type: none"> • script (including JavaScript) • svg • frame • frameset • iframe • any event handlers </div>
Guest access	<ul style="list-style-type: none"> ✓ True: Anyone that can access the URL, has viewing rights to the system. ✗ False (default): The user is asked to sign in before having access to any data.
Enable schema introspection	<ul style="list-style-type: none"> ✓ True: Schema fields are shown during an introspection. ✗ False (default): Schema fields are hidden during an introspection.
Enabel customer validation functions	<ul style="list-style-type: none"> ✓ True (default): Groovy scripts with custom validation functions can be loaded. ✗ False: Groovy scripts with custom validation functions cannot be loaded.

LDAP

The configuration of an LDAP server to handle the authentication.

Setting	Description
Enable LDAP integration (Requires restart)	<ul style="list-style-type: none"> ✓ True: The LDAP integration is enabled. ✗ False (default): The LDAP integration is disabled.
Sync after restore	<ul style="list-style-type: none"> ✓ True (default): LDAP data is synchronized with Collibra DGC when an initial data set is bootstrapped. ✗ False: LDAP data is synchronized with Collibra DGC only when the LDAP synchronization job is triggered.
User page size	<p>The page size that is used when retrieving users during synchronization.</p> <p>The default value is 500. You can set it to 0 to disable paging.</p> <div style="border: 1px solid #ccc; padding: 5px; margin-top: 10px;"> <p>Note This is a global setting. If you are working with multiple LDAP servers, only the value for the main server is taken into account.</p> </div>
Group page size	<p>The page size that is used when retrieving groups.</p> <p>You can set it to 0 to disable paging.</p> <div style="border: 1px solid #ccc; padding: 5px; margin-top: 10px;"> <p>Note This is a global setting. If you are working with multiple LDAP servers, only the value for the main server is taken into account.</p> </div>
Time limit	<p>Specifies the time limit in milliseconds for all LDAP searches.</p> <p>The default value is 120,000.</p> <p>You can set it to 0 to disable the time limit.</p> <div style="border: 1px solid #ccc; padding: 5px; margin-top: 10px;"> <p>Tip</p> <ul style="list-style-type: none"> If you get Time limit Exceeded error messages, increase the default value or check why the LDAP search takes too long. We recommend that you modify the User page size and Group page size settings before you modify this setting. </div>
Sync job enabled	<ul style="list-style-type: none"> ✓ True (default): The synchronization job is enabled. ✗ False: The synchronization job is disabled.

Setting	Description
Sync job cron	<p>The schedule to perform an LDAP synchronization (CRON).</p> <p>The default value for this setting is daily at midnight.</p> <p>If you create an invalid Cron pattern, Collibra Data Governance Center stops responding.</p>
User field mapping	The configuration mapping of all the user fields. This determines which LDAP field is mapped to which user field. Empty fields are ignored during the synchronization.
Username	The unique user ID in the LDAP, typically UID. This is a mandatory field.
Email	The corresponding email field in the LDAP directory. This is a mandatory field.
First name	The first name field in the LDAP directory.
Last name	The last name field in the LDAP directory.
Middle name	The middle name field of the LDAP directory, this is usually givenName.
Enabled	Indication whether a user is active or inactive in LDAP.
Language	<p>The language and locale of the user. It has to contain a language code and may contain a country code.</p> <ul style="list-style-type: none"> • The language has to be an ISO language code. • The country has to be an ISO country code. <p>Examples: <i>pl</i>, <i>en_US</i>, <i>nl_BE</i>.</p>
Group	The LDAP property that defines to which groups the user belongs. If there is a group entry in the LDAP directory, use the Group field mapping settings.
Additional email list	An additional email list.
Instant messaging fields	The mapping for the user's IM locations.
AIM	The mapping for the user's AOL IM account.
Google Talk	The mapping for the user's Google Talk IM account.

Setting	Description
Icq	The mapping for the user's ICQ IM account.
Jabber	The mapping for the user's Jabber IM account.
Messenger	The mapping for the user's Live Messenger IM account.
Skype	The mapping for the user's Skype IM account.
Yahoo Messenger	The mapping for the user's Yahoo Messenger IM account.
Website map	Enter the field value and field key to map a social media website.
Phone	The mapping for the user's phone.
Fax	The mapping for the user's fax number.
Mobile	The mapping for the user's mobile number.
Pager	The mapping for the user's pager number.
Private	The mapping for the user's private number.
Work	The mapping for the user's work number.
Other	The mapping for any other phone number for this user.
Home address	The mapping for the user's home address.
Street	The mapping for the user's street.
Number	The mapping for the user's number.
City	The mapping for the user's city.
Post code	The mapping for the user's postal code.
State	The mapping for the user's state.
Country	The mapping for the user's country.

Setting	Description
Work address	The mapping for the user's work address.
Street	The mapping for the user's street.
Number	The mapping for the user's number.
City	The mapping for the user's city.
Post code	The mapping for the user's postal code.
State	The mapping for the user's state.
Country	The mapping for the user's country.
Gender	The mapping information for the user's gender.
Mapping	The attribute key for the gender value. If the content equals one of the male or female mappings, the user will be saved as male or female. Otherwise a default of <i>UNKNOWN</i> will be used.
Male value	The value for male users.
Female value	The value for female users.
Group field mapping	Groups can be defined as a separate structure or as a userField. The following section allows you to sync with a group structure that is unrelated to the user structure.
Group name field	The name of the group to use in the application.
Users field	The user DNs that are member of the group.

Password

The configuration of passwords.

Setting	Description
Minimum length (Requires restart)	The minimum length of passwords. The default minimum length is 12.
Maximum length (Requires restart)	The maximum length of passwords. The default maximum length is 1,024.
Digits required (Requires restart)	<ul style="list-style-type: none"> • ✓ True (default): Passwords have to contain one or more digits. • ✗ False: Passwords do not have to contain digits.
Non alpha-numeric required (Requires restart)	<ul style="list-style-type: none"> • ✓ True (default): Passwords have to contain one or more non-alphanumeric (special) characters. • ✗ False: Passwords do not have to contain non-alphanumeric characters.
Uppercase required (Requires restart)	<ul style="list-style-type: none"> • ✓ True (default): Passwords have to contain one or more upper-case characters. • ✗ False: Passwords do not have to contain upper-case characters.
Lowercase required (Requires restart)	<ul style="list-style-type: none"> • ✓ True (default): Passwords have to contain one or more lower-case characters. • ✗ False: Passwords do not have to contain lower-case characters.
Username disallowed (Requires restart)	<ul style="list-style-type: none"> • ✓ True (default): Passwords cannot be the username. • ✗ False: Passwords can be the username.
Expiration interval (months)	The number of months before users have to change their passwords. Set it to 0 if users never have to change their passwords. The default interval is 6 months.
Allowed login failures	The number of consecutive failed login attempts that are allowed before the user account is disabled. Set it to 0 for unlimited attempts. The default is 3 login failures.
No reuse count	The number of previous passwords users cannot reuse. The default is 1: the user cannot change his password to what it currently is. Set this to 0 to allow using the same password.

Setting	Description
Password reset link validity period	<p>The number of minutes that a link to reset a password remains valid. Beyond this time, the user has to request a new password reset link.</p> <p>The default value is 60 minutes.</p> <p>The minimum value is 15 minutes, the maximum value is 1,440 minutes (24 hours).</p>
Account lock-out duration	<p>The number of minutes that a user cannot sign in after too many failed sign-in attempts. If the number of minutes is set to 0, a Collibra DGC administrator must reset the password to unlock the account. This setting is only applicable if the "Allowed sign-in failures" setting is defined.</p> <p>A locked-out account does not mean that your account is disabled.</p>

REST

The security configuration of the REST interface.

Setting	Description
CSRF token enabled	<ul style="list-style-type: none"> ✓ True: The validity of a request is checked with a CSRF token. ✗ False (default): The validity of a request is not checked with a CSRF token.
Referrer enabled	<ul style="list-style-type: none"> ✓ True: The HTTP referrer header is used to identify the origin of the request. ✗ False (default): The HTTP referrer header is not used to identify the origin of the request. It is recommended to leave this option disabled.
Referrer checking allow empty	<ul style="list-style-type: none"> ✓ True (default): The HTTP referrer header can be empty. ✗ False: The HTTP referrer header cannot be empty.

SSL

The configuration of SSL.

Setting	Description
Key store name	The name of the keystore file. The file is expected to be in the <collibra_data>/dgc/security folder.
Key store password	The password of the keystore.
Key store type	The type of the keystore file. For example, <i>JKS</i> or <i>PKCS12</i> .
Trust store name	The name of the truststore file. The file is expected to be in the <collibra_data>/dgc/security folder.
Trust store password	The password of the truststore.
Trust store type	The type of the truststore file. For example, <i>JKS</i> or <i>PKCS12</i> .

SSO

The configuration of Single Sign-On (SSO) authentication.

Setting	Description
Mode	<p>The SSO mode of Collibra DGC.</p> <p>The possible values are:</p> <ul style="list-style-type: none"> • SAML_ATTRIBUTES • SAML_LDAP • SSO_HEADER • SSO_HEADER_LDAP • DISABLED
Header	<p>The name of the header to be checked. The contents of this header is used for the search query, which is <i>SSO_HEADER = username</i>.</p> <p>The value of the actual query depends on DN and possibly Attribute.</p>

Setting	Description
DN	<p>If the SSO mode is SSO_HEADER_LDAP or SAML_LDAP, this field determines whether the distinguished name (DN) or attribute is used:</p> <ul style="list-style-type: none"> • ✓ True: The header has to contain the distinguished name (DN) of the user in the LDAP. • ✗ False (default): The header has to contain the value of Attribute. <p>If the SSO mode is DISABLED, SSO_HEADER or SAML_ATTRIBUTES, this field is ignored.</p>
Attribute	<p>This field is only used if the SSO mode is SSO_HEADER_LDAP or SAML_LDAP, and if DN is False.</p> <p>If the above criteria are met, the LDAP has to contain this value.</p> <p>Example If Attribute is <i>FirstName</i>, then the header should contain the FirstName of the user that was signed in.</p>
Disable automatic user creation when signing in via SSO	<p>If users try to sign in via SSO, they still need a user account in Collibra DGC. You can either create the user accounts automatically when they sign in, or create the user accounts manually or via LDAP synchronization</p> <ul style="list-style-type: none"> • ✓ True: User accounts are not created automatically. • ✗ False (default): User accounts are created automatically.
Disable the Collibra DGC signin page	<p>When SSO is enabled, a user can still navigate to the /signin page and try to log in via that page. However, you can disable that page.</p> <ul style="list-style-type: none"> • ✓ True: Users cannot access the Collibra DGC signin page. • ✗ False (default): Users can access the Collibra DGC signin page
SAML	The configuration of SAML.
Metadata HTTP	The URL of the SAML metadata file to be used. The URL always has to be reachable by the Collibra DGC environment.
Entity Provider Entity ID	<p>The entity ID inside the metadata to be referenced.</p> <div style="border: 1px solid #ccc; padding: 5px; margin-top: 10px;"> <p>Note A metadata file can describe multiple entity IDs, make sure to use in the entity ID from the correct metadata file.</p> </div>

Setting	Description
Attribute fields	<p>The mappings of attributes in the SAML response. The values are used as keys to look for in the SAML response.</p> <p>Examples of attribute fields are first name, last name, address information, phone numbers and so on.</p>
First name	<p>The mapping for the user's first name.</p> <p>This attribute is optional. The value can be empty.</p>
Last name	<p>The mapping for the user's last name.</p> <p>This attribute is optional. The value can be empty.</p>
Email	<p>The mapping for the user's email address.</p> <p>This attribute is optional for existing users, but mandatory for new users.</p> <div style="border-left: 2px solid red; padding-left: 10px; margin-top: 10px;"> <p>Warning If the email address is invalid when you synchronize, the user is deactivated and the user information is not updated.</p> </div>
Enabled	<p>The mapping that indicates whether the account of the incoming user is enabled.</p>
Group	<p>The mapping (attribute) which indicates to which Collibra DGC groups the user should be added. If the groups don't exist yet, they will be created. This attribute can have multiple values (groups) or the groups can be sent as a comma-separated list of groups.</p> <p>If passing groups in this attribute, you must set Groups DGC Managed to <i>False</i>.</p>
Phone	<p>The mapping for the user's phone.</p>
Fax	<p>The mapping for the user's fax number.</p>
Mobile	<p>The mapping for the user's mobile number.</p>
Pager	<p>The mapping for the user's pager number.</p>
Private	<p>The mapping for the user's private number.</p>
Work	<p>The mapping for the user's work number.</p>

Setting	Description
Other	The mapping for any other phone number for this user.
Home address	The mapping for the user's home address.
Street	The mapping for the user's street.
Number	The mapping for the user's number.
City	The mapping for the user's city.
Post code	The mapping for the user's postal code.
State	The mapping for the user's state.
Country	The mapping for the user's country.
Work address	The mapping for the user's work address.
Street	The mapping for the user's street.
Number	The mapping for the user's number.
City	The mapping for the user's city.
Post code	The mapping for the user's postal code.
State	The mapping for the user's state.
Country	The mapping for the user's country.
Instant messaging	The mapping for the user's IM locations.
AIM	The mapping for the user's AOL IM account.
Google Talk	The mapping for the user's Google Talk IM account.
Icq	The mapping for the user's ICQ IM account.

Setting	Description
Jabber	The mapping for the user's Jabber IM account.
Messenger	The mapping for the user's Live Messenger IM account.
Skype	The mapping for the user's Skype IM account.
Yahoo Messenger	The mapping for the user's Yahoo Messenger IM account.
Gender	The mapping information for the user's gender.
Mapping	The attribute key for the gender value. If the content equals one of the male or female mappings, the user will be saved as male or female. Otherwise a default of <i>UNKNOWN</i> will be used.
Male value	The value for male users.
Female value	The value for female users.
Groups DGC managed	<p>Option to configure that groups should be managed by Collibra DGC, or that groups should be set by the SAML assertion (SAML+Attributes mode).</p> <p>This option is only relevant if Mode is <i>SAML_ATTRIBUTES</i>.</p> <ul style="list-style-type: none"> ✓ True: The groups are fully managed by Collibra DGC. In the UI the admin has the option to assign groups to users, without it being overwritten by SAML. ✗ False (default): The groups are managed by the SAML assertions. In this case the groups are managed by the SAML IDP. Be sure to configure the Group attribute in the Attribute Fields section.

Setting	Description
Service Provider Entity ID	<p>Field that determines the value of the <code>Entity ID</code> parameter in the service provider metadata returned by Collibra DGC. The default value is empty, in which case Collibra DGC uses the value of the <code>Base URL</code> field.</p> <p>Enter a custom value if the base URL does not match the audience configured in your SAML identity provider.</p> <div style="border: 1px solid #ccc; padding: 5px; margin-top: 10px;"> <p>Warning The value of the audience restriction in the SAML response has to be exactly the same as the value of this field.</p> </div> <div style="border: 1px solid #ccc; padding: 5px; margin-top: 10px;"> <p>Note SSO does not work if the Service Provider Entity ID field contains the base URL with trailing forward slash (for example <code>www.collibra.com/</code>), and the audience of your IDP contains the base URL without a trailing forward slash (for example <code>www.collibra.com</code>). Both values need to be exactly the same. In this case, you can resolve the issue by changing the value in the configuration of your IDP, or the value of this field. It does not matter whether both have a trailing forward slash or not, as long as they contain the same value.</p> </div>
Sign authentication requests (Requires restart)	<ul style="list-style-type: none"> • ✓ True: Authentication requests have to be signed. • ✗ False (default): Authentication request don't have to be signed.
Force authn	<ul style="list-style-type: none"> • ✓ True (default): The SP authentication request forces re-authentication. • ✗ False: The SP authentication request does not force re-authentication.
Force passive	<ul style="list-style-type: none"> • ✓ True: The reauthentication has to happen in the background. • ✗ False (default): The reauthentication does not have to happen in the background. <p>This is only relevant if Force authn is <i>True</i>.</p>
Name ID	<p>Name ID that is used in the SP authentication. The default value is <code>urn:oasis:names:tc:SAML:2.0:nameid-format:persistent</code>.</p> <p>The Name ID value is mandatory.</p>

Setting	Description
Name ID allow create	<ul style="list-style-type: none"> • ✓ True (default): The IDP can create a name ID to fulfill the SP authentication request. • ✗ False: The IDP cannot create a name ID to fulfill the SP authentication request.
Disable client address	<ul style="list-style-type: none"> • ✓ True: The validation of the client IP address in the assertion message is disabled. • ✗ False (default): The validation of the client IP address in the assertion message is enabled.
SAML Requested authentication context	Settings for the SAML requested authentication context. The IDP uses the authentication context to authenticate the user. By default, the authentication context mandates user/password authentication over HTTPS.
Disable	<ul style="list-style-type: none"> • ✓ True: The requested authentication context section is not sent in the SAML request. • ✗ False (default): The requested authentication context section is sent in the SAML request.
Comparison type	<p>The comparison type that is transmitted in the requested authentication context.</p> <p>Possible values:</p> <ul style="list-style-type: none"> • <i>minimum</i> • <i>maximum</i> • <i>better</i> • <i>exact</i> (default value) <p>For more information about the comparison type values, refer to the SAML specifications.</p>
Reference list	<p>The list of class references in the requested authentication context. You can separate list items with the pipe character ().</p> <p>For more information about this list, refer to the SAML specifications.</p>
Declaration list	<p>The list of class declarations in the requested authentication context. You can separate list items with the pipe character ().</p> <p>For more information about this list, refer to the SAML specifications.</p>

Setting	Description
Response decryption mode	<p>Enable the support for encrypted SAML responses.</p> <ul style="list-style-type: none"> • DISABLED: Collibra DGC only accepts plain-text SAML responses. • OPTIONAL: Collibra DGC can handle both encrypted and plain-text SAML responses. • FORCED: Collibra DGC only accepts encrypted SAML responses. <p>Once OPTIONAL or FORCED is selected, the encryption key pair is generated and added to the Collibra DGC SAML keystore. A self-signed certificate is generated and works in most situations. If your IdP rejects self-signed certificates, you will have to add a certificate that is signed by a trusted 3rd party.</p>
Validity period of the SAML certificate	<p>The SAML certificate expiry date in years.</p> <p>By default, the SAML certificate expires after 20 years.</p>

Signout

The configuration of redirecting after signing out of Collibra DGC.

Setting	Description
Override signout URL (Requires restart)	<ul style="list-style-type: none"> • <input checked="" type="checkbox"/> True: Redirect the user to a specific website after signing out. • <input type="checkbox"/> False (default): Redirect the user to the sign-in page after signing out.
Signout redirect URL (Requires restart)	The URL to be redirected to when signing out.

Import/Export

The configuration to avoid the Formula Injection vulnerability in Excel.

Setting	Description
Escape Excel formulas	<p>The option to disable Formula Injection into Excel. When enabling this option, an escape character is added at the beginning of Excel formulas during the export and is removed when importing formulas.</p> <p>The escape character will be added to fields that start with one of the following characters:</p> <ul style="list-style-type: none"> • equation: = • plus: + • minus: - • at-sign: @ <p>This option is enabled by default.</p>
Excel formulas escape character	The escape character for Excel formulas when exporting or importing data.

JWT

The JSON Web Token configuration.

Setting	Description
JSON Web Key Set URL	<p>The URL to retrieve public key information needed to verify the authenticity of JSON Web Tokens (JWTs), issued by an authorization server.</p> <p>This setting is required to enable JWT authentication.</p>
JWT Token Types	<p>A case-insensitive comma-separated list of accepted JWT media types coming in the typ header parameter.</p> <p>Leave blank if the authorization server does not provide a media type parameter.</p> <p>The default values is at+jwt,jwt.</p>
JWT Algorithms	<p>A comma-separated list of accepted JWT algorithms coming in the alg header parameter. See https://tools.ietf.org/html/rfc7518#section-3.1 for details.</p> <p>Leave blank to accept all digital signature algorithms.</p>
JWT Issuer	<p>The accepted issuer coming in the iss JWT claim.</p> <p>Leave blank if the authorization server does not provide an issuer claim.</p>

Setting	Description
JWT Audience	<p>A comma-separated list of accepted audience values for the aud claim.</p> <p>The value for this field is a configuration setting in your authorization server, which identifies your Collibra DGC environment as the intended recipient of the JWT.</p> <p>Leave blank if the authorization server does not provide an audience claim.</p>
JWT Principal ID Claim Name.	<p>The name of the JWT claim containing the principal's identity. See https://tools.ietf.org/html/rfc7519#section-4.1.2 for details.</p> <p>Defaults to the standard subject claim, sub.</p> <p>Change this setting only if your authorization server has other means of identifying the principal, for example, a client_id claim.</p> <p>This setting is required if JWT authentication is enabled.</p>
JWT Maximum Clock Skew	<p>The maximum acceptable difference in seconds between the clocks of the machines running the authorization server and Collibra DGC.</p> <p>Differences smaller than the given amount are ignored when performing time comparisons for token validation.</p> <p>The default value is 60 seconds if left blank.</p>

Whitelists

The configuration for whitelist placeholders that can be used in security headers.

Option	Description
connect-src whitelist	The 'connect-src' whitelist. To use this whitelist in a security header, use the '{connectSrcWI}' placeholder.
font-src whitelist	The 'font-src' whitelist. To use this whitelist in a security header, use the '{fontSrcWI}' placeholder.
frame-src whitelist	The 'frame-src' whitelist. To use this whitelist in a security header, use the '{frameSrcWI}' placeholder.
img-src whitelist	The 'img-src' whitelist. To use this whitelist in a security header, use the '{imgSrcWI}' placeholder.

Option	Description
script-src whitelist	The 'script-src' whitelist. To use this whitelist in a security header, use the '{scriptSrcWI}' placeholder.
style-src whitelist	The 'style-src' whitelist. To use this whitelist in a security header, use the '{styleSrcWI}' placeholder.
frame-ancestors whitelist	The 'frame-ancestors' whitelist. To use this whitelist in a security header, use the '{frameAncestorsWI}' placeholder.
Tableau frame-ancestors whitelist	The tableau 'frame-ancestors' whitelist. To use this whitelist in a security header, use the '{tableauFrameAncestorsWI}' placeholder.

Disclaimer

The configuration of a disclaimer upon signing in to Collibra DGC.

Setting	Description
Disclaimer	<ul style="list-style-type: none"> ✓ True: Upon signing in, show a disclaimer that you have to agree with before you can continue. ✗ False (default): Don't show a disclaimer.
Disclaimer message	<p>The disclaimer message that is shown after signing in.</p> <p>If you leave this field empty, there is a default message.</p> <p>You can use basic html tags, such as headers, paragraphs, images and hyperlinks.</p>

Collibra Connect

The configuration to communicate with Collibra Connect.

Setting	Description
Base URL	The URL to Collibra Connect.
Username	The username to connect to Collibra Connect.

Setting	Description
Password	The password to connect to Collibra Connect.

Register data source

Global parameters that apply to Data Source Registration.

Setting	Description
Table types to ignore	A comma separated list of table types that are not ingested. For example, <i>INDEX</i> and <i>SEQUENCE</i> .
AWS regions restriction	A list of AWS regions Data Catalog is allowed to connect to. For example, <i>eu-west-3</i> and <i>us-east-2</i> . For a list of all AWS locations, see the AWS documentation . If you want to allow Collibra DGC to make a connection to any AWS region, leave the field empty.
AWS API call rate	Allowed number of AWS API calls per second. Use this option to limit the number of API calls per second to prevent throttling errors from the AWS API.
Database registration via Edge	An option to enable database registration via Edge. <ul style="list-style-type: none"> ✓ True: Register a data source via Edge. ✗ False: Register a data source via Jobserver only. <div style="border: 1px solid #ccc; padding: 5px; margin-top: 10px;"> <p>Note Enabling data source registration via Edge does not prevent you from registering a data source via Jobserver as well.</p> </div>
Data Quality Synchronization UI via DQ Connector on Edge	An option to enable the Data Quality extraction interface in Collibra DGC <ul style="list-style-type: none"> ✓ True: The Quality extraction tab is available on the configuration page of a database asset ✗ False (default): The Quality extraction tab is not available and as such, it is not possible to extract and synchronize data quality information. <p>You can only enable Data Quality synchronization if you also enabled Database registration via Edge.</p>

Jobserver (*)

The configuration of the Jobserver service.

Setting	Description
Jobserver list	The list of registered Jobserver instances.
Name	<p>The name of the Jobserver as it will appear when you register a data source in Data Catalog.</p> <p>The name is a freely chosen name but it is recommended to only use alphanumerical characters and dashes, for example Jobserver-1.</p> <p>You will have to use this name as the ID of the gateway and in the address of this configuration.</p>
Protocol	<p>The protocol that is used for the communication between the Data Governance Center service and the Jobserver service.</p> <p>It is recommended to use HTTPS, especially if the services are hosted in different network segments.</p>
Address	The address (IP address, URL, hostname) of the Jobserver.
Trusted server CA certificate	<p>The certificate of the trusted CA needed to validate the server certificate. If blank, the default truststore will be used. The default truststore is defined in the SSL configuration section of the DGC service.</p> <p>The CA certificate of the server party (Jobserver).</p>
Client certificate	The client certificate offered by the DGC service to the server. If blank, you cannot select mutual authentication as the Jobserver service authentication level.
Client private key	The private key of the DGC service's certificate.
Table profiling data size	The approximate maximum disk size of the data in MB that will be used to profile a table. The value cannot exceed 10,000.
Test connection timeout	This timeout is a time limit (in seconds) after which the connection test is stopped and a timeout error is shown. The default value is 60 seconds.

Data profiling

The global configuration of Data Profiling. Profiling must be executed again after a change in this section.

Setting	Description
Maximum number of samples	The maximum number of rows taken as a sample during profiling.
Maximum value length	The maximum length of a value extracted during profiling or sampling. Additional characters are trimmed.
Default date pattern	The default format used to decode dates. It is the default pattern used for detecting dates when the Date Pattern and/or Time Pattern attribute is not specified in Column assets.
Default time pattern	The default format used to decode times. It is the default pattern used for detecting times when the Date Pattern and/or Time Pattern attribute is not specified in Column assets.
Default combined date and time pattern	The default format used to decode combined dates and times. It is the default pattern used for detecting combined dates and times when the Date Pattern and/or Time Pattern attribute is not specified in Column assets.
Empty values	<p>A comma separated list of strings enclosed in double quotes. A value that matches one of those expressions is considered an empty value.</p> <p>Please note that a database null value is always considered an empty value, for example "", "na" and "none".</p>
Data type detection threshold	The percentage of matching Column values to reach for an Advanced Data Type to be considered a possible Data Type for that Column. This is expressed as a value between 0.0 and 1.0).
Anonymize data	<p>An option to anonymize sensitive data.</p> <ul style="list-style-type: none"> ✓ True: Content in columns with data type Text or Geo is removed or replaced by a random hash value before the profiling results are sent to the cloud. ✗ False (default): No content is removed or replaced by a random hash value.

Setting	Description
Database profiling via Edge	<p>An option to enable profiling and classifying synchronized metadata via Edge instead of Jobserver.</p> <ul style="list-style-type: none"> ✓ True: Profiling and classify via Edge. ✗ False: Profile via Jobserver and classify via the Data Classification Platform. <p>Note You can only enable Database profiling via Edge if you also enabled Database registration via Edge.</p>

Beta features

The configuration of features in beta state.

Setting	Description
Tableau provisioning enabled	<ul style="list-style-type: none"> ✓ True: Provisioning to Tableau is enabled. ✗ False (default): Provisioning to Tableau is disabled.
Max number of concurrent import jobs	<p>The maximum number of import jobs that can be executed at the same time via the API. This is to avoid memory issues.</p> <p>Default value is 4, set to 0 if there is no limit.</p>
Task sidebar	<ul style="list-style-type: none"> ✓ True: Workflow tasks appear in the sidebar on both resource pages and the task management page. Task forms appear in the sidebar instead of dialog boxes. Users can seamlessly complete their tasks from the task management page and have a side-by-side view of the tasks and resource details on resource pages. ✗ False (default): Workflow tasks appear in the task bar on resource pages and in a sidebar on the task management page. Task forms appear in dialog boxes. The behavior is the same as with older versions of Collibra DGC.

Setting	Description
Settings landing enabled	<ul style="list-style-type: none"> • ✓ True: Show the new Settings landing page in your Collibra DGC environment. • ✗ False (default): Use the classic Settings page in your Collibra DGC environment.
Search reindex using Output Module	<ul style="list-style-type: none"> • ✓ True: Enable the use of the Output Module when executing a search reindex. • ✗ False (default): Disable the use of the Output Module when executing a search reindex.

Setting	Description
Throttling enabled	<ul style="list-style-type: none"> • ✓ True: REST API v1 throttling is enabled. • ✗ False (default): REST API v1 throttling is disabled.
Number of requests	The number of allowed request for the configured number of seconds.
Number of seconds	The number of seconds during which the configured number of requests can be performed.

Setting	Description
Throttling enabled	<ul style="list-style-type: none"> • ✓ True: REST API v2 throttling is enabled. • ✗ False (default): REST API v2 throttling is disabled.
Number of requests	The number of allowed request for the configured number of seconds.
Number of seconds	The number of seconds during which the configured number of requests can be performed.

Setting	Description
Throttling enabled	<ul style="list-style-type: none"> ✓ True: GraphQL throttling is enabled. ✗ False (default): GraphQL throttling is disabled.
Number of requests	The number of allowed request for the configured number of seconds.
Number of seconds	The number of seconds during which the configured number of requests can be performed.

Graph query

The configuration of the Graph query engine which is used to retrieve data from the repository.

For the general Graph query settings, you need the SUPER role. Contact [Collibra support](#) if you want to edit these settings.

Graph query limits

Setting	Description
Enables limiting of the number of root nodes in result	<ul style="list-style-type: none"> ✓ True: Enable limiting the number of root elements as result of a Graph query. ✗ False (default): Disable limiting the number of root elements as result of a Graph query.

Setting	Description
Maximum number of root nodes that can be requested with graph query API	<p>The maximum number of root nodes that you can request in the view configuration of an API call (REST or workflow).</p> <p>If you exceed this value in the view configuration, an exception is shown. If no value is defined in the view configuration, then the default value is taken.</p> <p>The default value is 100,000.</p> <div style="border: 1px solid #ccc; padding: 5px; margin-top: 10px;"> <p>Note If the number of asset types or domain types exceeds the set number, the hierarchy will be incomplete. Make sure that the limit is always higher than the actual number of asset and domain types.</p> </div>

Graph query timeouts

Setting	Description
Maximum number of minutes a graph query can run	<p>The maximum number of minutes that the graph query runs before it will time out. The maximum is 1,440 minutes (1 day).</p> <p>The default value is 480.</p>

Table

The configuration of tables.

Setting	Description
Time limit for loading data in tables in seconds	<p>The time limit after which a table stops loading on a page.</p> <p>Example A value of <i>600</i> means that if a table hasn't loaded within 600 seconds, the task is canceled and a timeout error is shown.</p> <p>The default value is 60, the maximum value is <i>720</i> seconds.</p>

Multi-column sort

The configuration of multi-column sorting.

Setting	Description
Multi-column sorting on tables	<ul style="list-style-type: none"> ✓ True: Tables can be sorted on multiple columns. ✗ False (default): Tables can be sorted on one column.
Number of columns available for multi-sort	<p>Type the maximum number of columns that can be used to simultaneously sort tables.</p> <p>The default value is 3, the minimum is 1, the maximum is 9.</p> <p>This setting is only relevant is Multi-column sorting on tables is <i>True</i>.</p>

Inherited responsibilities

Setting	Description
Enable Inherited Responsibilities	<ul style="list-style-type: none"> ✓ True: Show inherited responsibilities on asset views. ✗ False (default): Do not show inherited responsibilities on asset views. <p>Note This setting only affects asset views and tile sets. It does not affect the Responsibilities tab page of asset pages.</p>

Cloud Data Classification configuration

With data classification you can automatically assign data classes to ingested data.

Note In a Collibra Data Intelligence Cloud environment, you have to create a support ticket to configure this feature.

Setting	Description
Enable Data Classification	<ul style="list-style-type: none"> ✓ True: Enable Collibra's data classification technology. ✗ False (default): Do not use Collibra's data classification technology are not accepted.

Reporting

For more information about these settings, see Introduction to the Reporting Data Layer.

Setting	Description
Cloud Provider	Cloud provider - AWS or GCP
Customer GUID	<p>The GUID of your Collibra DGC environment.</p> <p>Note This field is configured by Collibra Cloud Ops.</p>
Collibra Insights download bucket name	<p>The name of the AWS S3 bucket in which your reporting data is stored.</p> <p>Note This field is configured by Collibra Cloud Ops.</p>
Collibra Insights AWS S3 Region	<p>The AWS S3 region in which your data is processed.</p> <p>Note This field is configured by Collibra Cloud Ops.</p>
Collibra Insights zip location pattern	<p>A pattern with the format "/zip/insights_%s.zip", where "%s" is replaced by the Collibra Insights snapshot date.</p> <p>Note This field is configured by Collibra Cloud Ops.</p>

Setting	Description
Tableau report URL pattern	<p>The Tableau URL pattern, which should contain {reportName}.</p> <p>Tip You can paste the URL from the Link field in Tableau, as described in Generate the dashboard reports you configured in Collibra Data Intelligence Cloud Settings.</p>
Reports definitions	
Report view name	The report name, as you want it to appear on the report button in the Collibra Insights widget, for example "Data Maturity Dashboard".
Report name	The report name, as it appears in the URL of the Tableau report, for example "DataMaturityDashboard".

Catalog Experience

Data Catalog Experience improves the layout of Data Catalog's asset pages.

Setting	Description
Enable Catalog experience	<ul style="list-style-type: none"> ✓ True: Catalog experience is enabled. This will improve the layout of Data Catalog's asset pages, such as those of Data Set, Schema, Table and Column assets. ✗ False: Catalog experience is disabled.
Catalog Experience Titlebar theme	<p>The theme for the Catalog experience. You can choose between the LIGHT and DARK.</p> <p>This option is only applicable if the Enable Catalog experience option is enabled.</p>

Diagrams

These settings determine dialog loading time and size limits.

Setting	Description
<p>Maximum loading time for the back end</p>	<p>The time limit, in seconds, after which a diagram stops fetching data.</p> <p>The value must be a positive integer and cannot be greater than 3,600 (one hour).</p> <p>The default value is 300.</p> <div data-bbox="432 495 1417 658" style="background-color: #f0f0f0; padding: 10px;"> <p>Example A value of <i>300</i> means that if a diagram hasn't fetched all data within 300 seconds, the diagram stops fetching data and an empty diagram with a notification is shown.</p> </div>
<p>Size limit for the backend</p>	<p>The maximum number of nodes plus edges that will be fetched by the backend, to build a diagram.</p> <p>The value must be a positive integer and cannot be greater than 100,000.</p> <p>The default value is 10,000.</p> <div data-bbox="432 909 1417 1039" style="background-color: #f0f0f0; padding: 10px;"> <p>Example A value of <i>10,000</i> means that if the total number of nodes plus edges is greater than 10,000, the diagram does not load and a notification is shown.</p> </div>
<p>Size limit for the frontend</p>	<p>The maximum number of visible nodes plus edges that can be shown on the page.</p> <p>The value must be a positive integer and cannot be greater than 10,000.</p> <p>The default value is 2,000.</p> <div data-bbox="432 1249 1417 1413" style="background-color: #f0f0f0; padding: 10px;"> <p>Example A value of <i>2,000</i> means that if the total number of visible nodes and edges is greater than 2,000, the diagram does not load and a notification is shown.</p> </div>
<p>Maximum flow depth</p>	<p>The system-wide maximum number of flow relations between the start node and any other diagram node.</p> <p>The value must be an integer between 1 and 100.</p> <p>The default value is 50.</p> <div data-bbox="432 1671 1417 1865" style="background-color: #f0f0f0; padding: 10px;"> <p>Note</p> <ul style="list-style-type: none"> • If the maximum flow depth is specified in the selected diagram view, that value supersedes the maximum you specify here. • You can also manually adjust the flow depth in the diagram. </div>

Setting	Description
Diagrams Business Qualifier Filter (*)	<ul style="list-style-type: none"> ✓ True: Users can filter diagrams by a specified Business Qualifier asset. ✗ False (default): Users are unable to filter diagrams by Business Qualifier.

Setting	Description
Domains	Add a web domain , for example of a web application such as Power BI or Tableau, on which the Browser Extension automatically appears as overlay.

Edge

Edge configuration options, when changing an option, you only have to refresh the page that runs your Collibra DGC environment.

Setting	Description
Enable Edge jobs feature (beta)	<ul style="list-style-type: none"> ✓ True: Enable the Edge jobs page, this page gives you a overview of all jobs and their status. ✗ False (default): Disable the Edge jobs page.

Tableau Metadata API

You need the [Tableau metadata API](#) to ingest Tableau 2020.2 and newer.

Warning If you upgrade to Tableau version 2020.2 or newer, but previously synchronized an older Tableau version via the REST API and XML mapping, you have to prepare the [migration procedure](#) to prevent losing manually added relations, attributes, tags, comments and stitching results.

Setting	Description
Enable Tableau metadata API	<ul style="list-style-type: none"> ✓ True: Tableau metadata API is enabled. This enables you to ingest Tableau 2020.2 or newer into Data Catalog. ✗ False: Tableau metadata API is disabled. If you ingest Tableau 2020.2 or newer, the ingestion will fail. This prevents data loss of manually added relations and attributes.

Backup configuration management

Setting	Description
Backup service URL	The URL of the backup service.

Job Service (Activities)

Setting	Description
Number of executor threads for the Job Service	<p>The maximum number of threads, or jobs, that the Job Service can run in parallel.</p> <p>Generally speaking, increasingly the number of jobs running in parallel reduces overall processing time. Conversely, it requires more system resources, which can negatively impact performance. It also increases the risk of job conflicts.</p>

Migration

The Migration feature allows you to migrate the operating model and views from one Collibra Data Governance Center environment to another environment. This makes it easier to migrate changes between development environments, testing environments and the actual production environment.

Migration is not meant to be used for backups, or to migrate instance data, such as assets and domains. You can use the [import and export](#) features to move assets to another environment. You can use [backups](#) for disaster recovery.

Note Exporting and importing CMA files is restricted by the file upload settings, which determine the maximum file size, allowed file extensions and maximum amount of uploads and downloads per day. Contact [Collibra support](#) if you want to change the file upload settings.

Warning

The versions of the source and target environment have to be the same. Migrating between different versions may lead to unexpected behavior.

For example, migrating does not work correctly if you import a CMA file in an environment of version 2021.07 or older if the CMA file includes assignments of any of the following asset types:

- BI Report Attribute
- Business Qualifier
- Column
- Field
- Looker Report Attribute
- Report Attribute
- Table
- Tableau Report Attribute

Overview of the migration procedure

1. **Export** objects from a source environment.
 - a. Choose the objects that you want to migrate.
 - b. Download the summary and the archive file.
 - c. Review the summary.
2. **Create** a backup of your target environment.

Note This is technically not mandatory, but highly recommended.

3. **Import** the archive file.
 - » You are guided through the import process. This process consists of the following main steps: upload the archive file, review the changes via a simulation, and start the import.
 - » Once the import is completed, the model objects are created, edited, or removed as necessary. You can also download an import report.

Best practice

It is highly recommended not to make risky changes to the metamodel of your Production environment. Instead, we recommend you use a separate Development environment and Testing environment:

1. [Create](#) a backup of your production environment.
2. [Restore](#) the backup in your Development and Testing environments.
3. Make the necessary changes in the Development environment.
4. Use the migration feature to re-apply the changes from the Development environment to the Testing environment.
5. Thoroughly test the changes in the Testing environment.
6. If required, repeat steps 3 to 5.
7. If you are satisfied with the changes, use the migration feature to re-apply the changes from the Testing environment to the Production environment.

Note Since migration moves the operating model, the existing instance data in the Production environment is not changed.

Export model objects



Using the [Migration](#) feature, you can export the model objects of a Collibra DGC environment, for example if you want to [import](#) them later in another environment.

Note Exporting and importing CMA files is restricted by the file upload settings, which determine the maximum file size, allowed file extensions and maximum amount of uploads and downloads per day. Contact [Collibra support](#) if you want to change the file upload settings.

Prerequisites

You have a [global role](#) that has the System administration [global permission](#).

Steps

1. In the main menu, click , then  **Settings**.
 - » The [Collibra DGC settings page](#) opens.
2. Click **Migration**.
 - » The migration page appears on the **Export** tab page.
3. Select the model objects that you want to export.

If you want to export...	Do the following:
Assignments	a. At the top of the page, click Asset type assignments . b. Select one or more assignments. <div style="background-color: #f0f0f0; padding: 5px; margin-top: 10px;"> Tip Click Select all to export all assignments, or click the name of a scope to export all assignments in that scope. </div>
Global roles	a. At the top of the page, click Global roles . b. Select one or more roles. <div style="background-color: #f0f0f0; padding: 5px; margin-top: 10px;"> Tip Click Select all to export all roles. </div>
Resource roles	a. At the top of the page, click Resource roles . b. Select one or more roles. <div style="background-color: #f0f0f0; padding: 5px; margin-top: 10px;"> Tip Click Select all to export all roles. </div>
Workflows	a. At the top of the page, click Workflows . b. Select one or more workflows. <div style="background-color: #f0f0f0; padding: 5px; margin-top: 10px;"> Tip Click Select all to export all workflows. </div>
Views	You can export different types of views, including asset views , dashboards , diagram views and search filters . <div style="background-color: #f0f0f0; padding: 5px; margin-top: 10px;"> Note You can only export views that are public or shared with a global role. </div>

If you want to export...	Do the following:
Dashboard views	a. At the top of the page, click Views . b. In the filter pane to the left, click the type of view that you want to export. » The views that are public or shared with a global role appear in the table. c. Select one or more views.
Diagram views	
Search filters	
Global asset views	
Asset views in application pages	Tip To export all available views of a certain type, you can select the checkbox in front of the view type in the filter pane. a. At the top of the page, click Views . b. In the filter pane to the left, click Asset views - in Applications . » The applications pages appear in the table. c. Do one of the following: <ul style="list-style-type: none"> ■ If you want to export all available views in all application pages, select the checkbox in front of Asset views - in Applications in the filter pane. ■ If you want to export all views of a specific application page, select the checkbox in front of the name of the application page. ■ If you want to export specific views, do the following: <ol style="list-style-type: none"> i. Click the name of an application page. » The available views appear in the right column. ii. Select one or more views.

If you want to export...	Do the following:
Asset views in communities and domains pages	<ol style="list-style-type: none"> a. Click Views. b. In the filter pane to the left, click Asset views - in Communities and Domains. <ul style="list-style-type: none"> » The organization browser appears in the table. c. Do one of the following: <ul style="list-style-type: none"> ▪ If you want to export all available views in all community and domain pages, select the checkbox in front of Asset views - in Communities and Domains in the filter pane. ▪ If you want to export all views of a community or domain, select the checkbox in front of the name of the community or domain. ▪ If you want to export specific views, do the following: <ol style="list-style-type: none"> i. Click the name of a community or domain. <ul style="list-style-type: none"> » The available views appear in the right column. ii. Select one or more views.

Note Referenced model objects are also exported based on the [export logic](#). For example, if you export a workflow, all roles to which the workflow refers are also exported.

4. In the upper-right corner, click **Export**.
 - » The **Provide file name and description** dialog box appears.
5. Enter the required information.

Field	Description
Archive file name	The name of the exported archive file. <div style="border: 1px solid #ccc; padding: 5px; margin-top: 10px;"> <p>Note The extension is always CMA, which is short for Collibra Migration Archive.</p> </div>
Report file name	The name of the report file, which contains a summary of the exported model objects. <div style="border: 1px solid #ccc; padding: 5px; margin-top: 10px;"> <p>Note You cannot edit the name of the report file.</p> </div>
Description	The description of the archive.

6. Click **Export**.
 - » The report and the archive are downloaded.
7. Click **Close**.

Migration export logic

The export logic of the migration feature determines how an object is exported: which fields it needs and which other objects it requires.

If you export an object, Collibra Data Governance Center automatically exports all referenced objects. For example, if you export a workflow, Collibra DGC will also all export roles, asset types and status to which the workflow refers. For that reason, the migration feature differentiates between primary objects and secondary objects:

- Primary objects are objects that you choose to migrate.
- Secondary objects are objects that are needed for the correct behavior of a primary object or another secondary object.

Primary objects

You can migrate most of the model objects and navigation artifacts:

- Model objects:
 - Assignments
 - Global roles
 - Resource roles
- Workflows
- Navigation artifacts that are public or shared with a role:
 - Table views
 - Dashboards
 - Diagram views
 - Search filters

Note

- For navigation artifacts, you cannot choose specific artifacts to migrate. All navigation artifacts that are public or shared with a role are migrated. Navigation artifacts that are private or only shared with specific users are not migrated.
- For model objects, you can choose specific objects to migrate. For example, you can migrate one specific workflow.
- You cannot choose to migrate anything else. Keep in mind that other objects might be migrated as secondary objects.

Secondary objects

Secondary objects are objects that are referenced by a primary object or by another secondary object. These could also be instance data.

These include the following objects:

- Assets
- Asset types
- Assets referenced by a filter clause on a relation type filter
- Characteristic types
 - Attribute types
 - Complex relation types
 - Relation types
- Communities
- Data quality rules
- Domain types
- Domains
- Roles
- Status
- Validation rules

Objects that cannot be migrated

Some objects will never be migrated. This is a non-exhaustive list:

- Attachments
- Comments

- Data quality scores
- Ratings
- Tags
- Tasks
- User groups
- Users

Export logic by object

The following table shows an overview of all objects, their exported fields and the secondary objects to which they can refer.

Object	Migrated fields and secondary objects
Asset	<ul style="list-style-type: none"> • Name • ID • Status <ul style="list-style-type: none"> ◦ ID ◦ Name ◦ Description • Parent domain <ul style="list-style-type: none"> ◦ ID ◦ Name ◦ Description ◦ Exclude from Autohyperlinking ◦ Domain type <ul style="list-style-type: none"> ▪ ID ▪ Name ▪ Description ▪ Parent domain types up to root <ul style="list-style-type: none"> ▪ ID ▪ Name ▪ Description ◦ Parent communities, up to the root level <ul style="list-style-type: none"> ▪ ID ▪ Name ▪ Description • Asset type <ul style="list-style-type: none"> ◦ ID ◦ Name ◦ Description ◦ Parent asset types, up to the root asset type (for example Business asset) ◦ Display options <ul style="list-style-type: none"> ▪ Color ▪ Symbol (none, Icon or Code) ▪ Code ▪ Icon reference ◦ displayNameEnabled

Object	Migrated fields and secondary objects
	<ul style="list-style-type: none">◦ ratingsEnabled
Asset type	<ul style="list-style-type: none">• ID• Name• Description• Parent asset types, up to the root asset type (for example Business asset)• Display options<ul style="list-style-type: none">◦ Color◦ Symbol (none, Icon or Code)◦ Code◦ Icon reference• displayNameEnabled• ratingsEnabled

Object	Migrated fields and secondary objects								
Assignment	<ul style="list-style-type: none"> • ID • Asset types referenced in the assignment <ul style="list-style-type: none"> ◦ ID ◦ Name ◦ Description ◦ Parent asset types, up to the root asset type (for example Business asset) ◦ Display options <ul style="list-style-type: none"> ▪ Color ▪ Symbol (none, Icon or Code) ▪ Code ▪ Icon reference ◦ displayNameEnabled ◦ ratingsEnabled • Articulation rules • Fields referenced in the assignment <ul style="list-style-type: none"> ◦ Attribute types <ul style="list-style-type: none"> ▪ ID ▪ Name ▪ Description ▪ Attribute type kind and its properties <table border="1" data-bbox="563 1301 1417 1827"> <thead> <tr> <th data-bbox="563 1301 740 1375">Kind</th> <th data-bbox="740 1301 1417 1375">Properties</th> </tr> </thead> <tbody> <tr> <td data-bbox="563 1375 740 1449">Date</td> <td data-bbox="740 1375 1417 1449">None</td> </tr> <tr> <td data-bbox="563 1449 740 1711">Multiple selection (Multi value list)</td> <td data-bbox="740 1449 1417 1711"> Allowed values <div style="border-left: 2px solid red; padding-left: 10px; margin-top: 5px;"> Warning The list of allowed values is overwritten in the target environment, so it may remove values. </div> </td> </tr> <tr> <td data-bbox="563 1711 740 1827">Numeric</td> <td data-bbox="740 1711 1417 1827"> <ul style="list-style-type: none"> ▪ Only integers ▪ Metric </td> </tr> </tbody> </table>	Kind	Properties	Date	None	Multiple selection (Multi value list)	Allowed values <div style="border-left: 2px solid red; padding-left: 10px; margin-top: 5px;"> Warning The list of allowed values is overwritten in the target environment, so it may remove values. </div>	Numeric	<ul style="list-style-type: none"> ▪ Only integers ▪ Metric
Kind	Properties								
Date	None								
Multiple selection (Multi value list)	Allowed values <div style="border-left: 2px solid red; padding-left: 10px; margin-top: 5px;"> Warning The list of allowed values is overwritten in the target environment, so it may remove values. </div>								
Numeric	<ul style="list-style-type: none"> ▪ Only integers ▪ Metric 								

Object	Migrated fields and secondary objects										
	<table border="1" data-bbox="563 331 1417 1016"> <thead> <tr> <th data-bbox="563 331 738 409">Kind</th> <th data-bbox="746 331 1417 409">Properties</th> </tr> </thead> <tbody> <tr> <td data-bbox="563 421 738 633">Script</td> <td data-bbox="746 421 1417 633"> Language. <div data-bbox="754 488 1409 622" style="border: 1px solid #ccc; background-color: #f0f0f0; padding: 5px; margin-top: 10px;"> Note This field is only used for validation rule assets. </div> </td> </tr> <tr> <td data-bbox="563 645 738 813">Selection (single value list)</td> <td data-bbox="746 645 1417 813">Allowed values (adding values, AND removals)</td> </tr> <tr> <td data-bbox="563 824 738 880">Text</td> <td data-bbox="746 824 1417 880">Plain text</td> </tr> <tr> <td data-bbox="563 891 738 1016">True/False (boolean)</td> <td data-bbox="746 891 1417 1016">Metric</td> </tr> </tbody> </table> <ul style="list-style-type: none"> ○ Relation types <ul style="list-style-type: none"> ■ ID ■ Description ■ Role ■ Co-role ■ Head asset type <ul style="list-style-type: none"> ■ ID ■ Name ■ Description ■ Parent asset types, up to the root asset type (for example Business asset) ■ Display options <ul style="list-style-type: none"> ■ Color ■ Symbol (none, Icon or Code) ■ Code ■ Icon reference ■ displayNameEnabled ■ ratingsEnabled ■ Tail asset type 	Kind	Properties	Script	Language. <div data-bbox="754 488 1409 622" style="border: 1px solid #ccc; background-color: #f0f0f0; padding: 5px; margin-top: 10px;"> Note This field is only used for validation rule assets. </div>	Selection (single value list)	Allowed values (adding values, AND removals)	Text	Plain text	True/False (boolean)	Metric
Kind	Properties										
Script	Language. <div data-bbox="754 488 1409 622" style="border: 1px solid #ccc; background-color: #f0f0f0; padding: 5px; margin-top: 10px;"> Note This field is only used for validation rule assets. </div>										
Selection (single value list)	Allowed values (adding values, AND removals)										
Text	Plain text										
True/False (boolean)	Metric										

Object	Migrated fields and secondary objects				
	<ul style="list-style-type: none"> ▪ ID ▪ Name ▪ Description ▪ Parent asset types, up to the root asset type (for example Business asset) ▪ Display options <ul style="list-style-type: none"> ▪ Color ▪ Symbol (none, Icon or Code) ▪ Code ▪ Icon reference ▪ displayNameEnabled ▪ ratingsEnabled ○ Complex relation types <ul style="list-style-type: none"> ▪ ID ▪ Name ▪ Description ▪ Display options <ul style="list-style-type: none"> ▪ Color ▪ Symbol (none, Icon or Code) ▪ Code ▪ Icon reference ▪ Attribute types <ul style="list-style-type: none"> ▪ ID ▪ Name ▪ Description ▪ Attribute type kind and its properties <table border="1" data-bbox="603 1527 1414 1680"> <thead> <tr> <th data-bbox="603 1527 778 1608">Kind</th> <th data-bbox="785 1527 1414 1608">Properties</th> </tr> </thead> <tbody> <tr> <td data-bbox="603 1608 778 1680">Date</td> <td data-bbox="785 1608 1414 1680">None</td> </tr> </tbody> </table> 	Kind	Properties	Date	None
Kind	Properties				
Date	None				

Object	Migrated fields and secondary objects														
	<table border="1" data-bbox="603 331 1417 1393"> <thead> <tr> <th data-bbox="608 338 778 409">Kind</th> <th data-bbox="783 338 1412 409">Properties</th> </tr> </thead> <tbody> <tr> <td data-bbox="608 416 778 667">Multiple selection (Multi value list)</td> <td data-bbox="783 416 1412 667"> Allowed values <div style="border-left: 2px solid red; padding-left: 5px; margin-top: 5px;"> Warning The list of allowed values is overwritten in the target environment, so it may remove values. </div> </td> </tr> <tr> <td data-bbox="608 674 778 786">Numeric</td> <td data-bbox="783 674 1412 786"> <ul style="list-style-type: none"> ▪ Only integers ▪ Metric </td> </tr> <tr> <td data-bbox="608 792 778 1010">Script</td> <td data-bbox="783 792 1412 1010"> Language. <div style="border-left: 2px solid gray; padding-left: 5px; margin-top: 5px;"> Note This field is only used for validation rule assets. </div> </td> </tr> <tr> <td data-bbox="608 1016 778 1182">Selection (single value list)</td> <td data-bbox="783 1016 1412 1182">Allowed values (adding values, AND removals)</td> </tr> <tr> <td data-bbox="608 1189 778 1261">Text</td> <td data-bbox="783 1189 1412 1261">Plain text</td> </tr> <tr> <td data-bbox="608 1267 778 1386">True/False (boolean)</td> <td data-bbox="783 1267 1412 1386">Metric</td> </tr> </tbody> </table> <ul style="list-style-type: none"> ▪ Minimum cardinality ▪ Maximum cardinality ▪ Leg types (relation types) <ul style="list-style-type: none"> ▪ Role ▪ Co-role ▪ Asset types that are head or tail of the relation types <ul style="list-style-type: none"> ▪ ID ▪ Name ▪ Description ▪ Parent asset types, up to the root asset type (for example Business asset) 	Kind	Properties	Multiple selection (Multi value list)	Allowed values <div style="border-left: 2px solid red; padding-left: 5px; margin-top: 5px;"> Warning The list of allowed values is overwritten in the target environment, so it may remove values. </div>	Numeric	<ul style="list-style-type: none"> ▪ Only integers ▪ Metric 	Script	Language. <div style="border-left: 2px solid gray; padding-left: 5px; margin-top: 5px;"> Note This field is only used for validation rule assets. </div>	Selection (single value list)	Allowed values (adding values, AND removals)	Text	Plain text	True/False (boolean)	Metric
Kind	Properties														
Multiple selection (Multi value list)	Allowed values <div style="border-left: 2px solid red; padding-left: 5px; margin-top: 5px;"> Warning The list of allowed values is overwritten in the target environment, so it may remove values. </div>														
Numeric	<ul style="list-style-type: none"> ▪ Only integers ▪ Metric 														
Script	Language. <div style="border-left: 2px solid gray; padding-left: 5px; margin-top: 5px;"> Note This field is only used for validation rule assets. </div>														
Selection (single value list)	Allowed values (adding values, AND removals)														
Text	Plain text														
True/False (boolean)	Metric														

Object	Migrated fields and secondary objects
	<ul style="list-style-type: none"> ▪ Display options <ul style="list-style-type: none"> ▪ Color ▪ Symbol (none, Icon or Code) ▪ Code ▪ Icon reference ▪ displayNameEnabled ▪ ratingsEnabled ▪ Minimum cardinality ▪ Maximum cardinality • Data quality rules referenced in the assignments <ul style="list-style-type: none"> ◦ ID ◦ Name ◦ Description ◦ Aggregation path <ul style="list-style-type: none"> ▪ Relation trace entries (path): The sequence of relation types and their direction <ul style="list-style-type: none"> ▪ ID ▪ Description ▪ Role ▪ Co-role ▪ Head asset type <ul style="list-style-type: none"> ▪ ID ▪ Name ▪ Description ▪ Parent asset types, up to the root asset type (for example Business asset) ▪ Display options <ul style="list-style-type: none"> ▪ Color ▪ Symbol (none, Icon or Code) ▪ Code ▪ Icon reference ▪ displayNameEnabled ▪ ratingsEnabled ▪ Tail asset type <ul style="list-style-type: none"> ▪ ID

Object	Migrated fields and secondary objects
	<ul style="list-style-type: none"> ▪ Name ▪ Description ▪ Parent asset types, up to the root asset type (for example Business asset) ▪ Display options <ul style="list-style-type: none"> ▪ Color ▪ Symbol (none, Icon or Code) ▪ Code ▪ Icon reference ▪ displayNameEnabled ▪ ratingsEnabled ▪ Categorization relation types <ul style="list-style-type: none"> ▪ ID ▪ Description ▪ Role ▪ Co-role ▪ Head asset type <ul style="list-style-type: none"> ▪ ID ▪ Name ▪ Description ▪ Parent asset types, up to the root asset type (for example Business asset) ▪ Display options <ul style="list-style-type: none"> ▪ Color ▪ Symbol (none, Icon or Code) ▪ Code ▪ Icon reference ▪ displayNameEnabled ▪ ratingsEnabled ▪ Tail asset type <ul style="list-style-type: none"> ▪ ID ▪ Name ▪ Description ▪ Parent asset types, up to the root asset type (for example Business asset)

Object	Migrated fields and secondary objects												
	<ul style="list-style-type: none"> ▪ Display options <ul style="list-style-type: none"> ▪ Color ▪ Symbol (none, Icon or Code) ▪ Code ▪ Icon reference ▪ displayNameEnabled ▪ ratingsEnabled <ul style="list-style-type: none"> ○ Data Quality Metrics: attribute types of the Metric attribute type kind <ul style="list-style-type: none"> ▪ ID ▪ Name ▪ Description ▪ Attribute type kind and its properties <table border="1" data-bbox="563 931 1417 1861"> <thead> <tr> <th data-bbox="563 931 740 1005">Kind</th> <th data-bbox="740 931 1417 1005">Properties</th> </tr> </thead> <tbody> <tr> <td data-bbox="563 1005 740 1081">Date</td> <td data-bbox="740 1005 1417 1081">None</td> </tr> <tr> <td data-bbox="563 1081 740 1346">Multiple selection (Multi value list)</td> <td data-bbox="740 1081 1417 1346"> Allowed values <div style="border-left: 2px solid red; padding-left: 10px; margin-top: 5px;"> Warning The list of allowed values is overwritten in the target environment, so it may remove values. </div> </td> </tr> <tr> <td data-bbox="563 1346 740 1458">Numeric</td> <td data-bbox="740 1346 1417 1458"> <ul style="list-style-type: none"> ▪ Only integers ▪ Metric </td> </tr> <tr> <td data-bbox="563 1458 740 1686">Script</td> <td data-bbox="740 1458 1417 1686"> Language. <div style="border-left: 2px solid gray; padding-left: 10px; margin-top: 5px;"> Note This field is only used for validation rule assets. </div> </td> </tr> <tr> <td data-bbox="563 1686 740 1861">Selection (single value list)</td> <td data-bbox="740 1686 1417 1861">Allowed values (adding values, AND removals)</td> </tr> </tbody> </table> 	Kind	Properties	Date	None	Multiple selection (Multi value list)	Allowed values <div style="border-left: 2px solid red; padding-left: 10px; margin-top: 5px;"> Warning The list of allowed values is overwritten in the target environment, so it may remove values. </div>	Numeric	<ul style="list-style-type: none"> ▪ Only integers ▪ Metric 	Script	Language. <div style="border-left: 2px solid gray; padding-left: 10px; margin-top: 5px;"> Note This field is only used for validation rule assets. </div>	Selection (single value list)	Allowed values (adding values, AND removals)
Kind	Properties												
Date	None												
Multiple selection (Multi value list)	Allowed values <div style="border-left: 2px solid red; padding-left: 10px; margin-top: 5px;"> Warning The list of allowed values is overwritten in the target environment, so it may remove values. </div>												
Numeric	<ul style="list-style-type: none"> ▪ Only integers ▪ Metric 												
Script	Language. <div style="border-left: 2px solid gray; padding-left: 10px; margin-top: 5px;"> Note This field is only used for validation rule assets. </div>												
Selection (single value list)	Allowed values (adding values, AND removals)												

Object	Migrated fields and secondary objects						
	<table border="1" data-bbox="563 331 1417 618"> <thead> <tr> <th data-bbox="563 331 740 409">Kind</th> <th data-bbox="745 331 1417 409">Properties</th> </tr> </thead> <tbody> <tr> <td data-bbox="563 416 740 483">Text</td> <td data-bbox="745 416 1417 483">Plain text</td> </tr> <tr> <td data-bbox="563 490 740 618">True/False (boolean)</td> <td data-bbox="745 490 1417 618">Metric</td> </tr> </tbody> </table> <ul style="list-style-type: none"> • Domain types referenced in the assignment <ul style="list-style-type: none"> ◦ Parent domain types up to root <ul style="list-style-type: none"> ▪ ID ▪ Name ▪ Description • If it is a scoped assignment: the scope of the assignment <ul style="list-style-type: none"> ◦ ID ◦ Name ◦ Description ◦ Communities <ul style="list-style-type: none"> ▪ ID ▪ Name ▪ Description ▪ Parent communities, up to the root level <ul style="list-style-type: none"> ▪ ID ▪ Name ▪ Description <div data-bbox="523 1420 1417 1872" style="background-color: #f0f0f0; padding: 10px; margin-top: 20px;"> <p>Note</p> <ul style="list-style-type: none"> ▪ If the scope contains an entire community that contains subcommunities and domains, the subcommunities and domains are not included. ▪ If domains or communities are included in the scope, their parent communities will be included too. Other children of its parent community will not be included, unless they are also in the scope. ▪ The domain type of the included domains are also included. </div>	Kind	Properties	Text	Plain text	True/False (boolean)	Metric
Kind	Properties						
Text	Plain text						
True/False (boolean)	Metric						

Object	Migrated fields and secondary objects				
	<ul style="list-style-type: none"> ◦ Domains <ul style="list-style-type: none"> ▪ ID ▪ Name ▪ Description ▪ Exclude from Autohyperlinking ▪ Domain type <ul style="list-style-type: none"> ▪ ID ▪ Name ▪ Description ▪ Parent domain types up to root <ul style="list-style-type: none"> ▪ ID ▪ Name ▪ Description ▪ Parent communities, up to the root level <ul style="list-style-type: none"> ▪ ID ▪ Name ▪ Description • If it is a scoped assignment: the global assignment. • Statuses referenced in the assignment <ul style="list-style-type: none"> ◦ ID ◦ Name ◦ Description • Validation rules referenced in the assignment <ul style="list-style-type: none"> ◦ Characteristic types that are referenced in the validation script <ul style="list-style-type: none"> ▪ Attribute types <ul style="list-style-type: none"> ▪ ID ▪ Name ▪ Description ▪ Attribute type kind and its properties <table border="1" data-bbox="603 1664 1417 1816"> <thead> <tr> <th data-bbox="603 1664 778 1742">Kind</th> <th data-bbox="778 1664 1417 1742">Properties</th> </tr> </thead> <tbody> <tr> <td data-bbox="603 1742 778 1816">Date</td> <td data-bbox="778 1742 1417 1816">None</td> </tr> </tbody> </table>	Kind	Properties	Date	None
Kind	Properties				
Date	None				

Object	Migrated fields and secondary objects														
	<table border="1" data-bbox="603 331 1417 1393"> <thead> <tr> <th data-bbox="608 338 778 409">Kind</th> <th data-bbox="783 338 1412 409">Properties</th> </tr> </thead> <tbody> <tr> <td data-bbox="608 416 778 667">Multiple selection (Multi value list)</td> <td data-bbox="783 416 1412 667"> Allowed values <div style="border-left: 2px solid red; padding-left: 5px; background-color: #f0f0f0;"> Warning The list of allowed values is overwritten in the target environment, so it may remove values. </div> </td> </tr> <tr> <td data-bbox="608 674 778 786">Numeric</td> <td data-bbox="783 674 1412 786"> <ul style="list-style-type: none"> ▪ Only integers ▪ Metric </td> </tr> <tr> <td data-bbox="608 792 778 1010">Script</td> <td data-bbox="783 792 1412 1010"> Language. <div style="border-left: 2px solid gray; padding-left: 5px; background-color: #f0f0f0;"> Note This field is only used for validation rule assets. </div> </td> </tr> <tr> <td data-bbox="608 1016 778 1182">Selection (single value list)</td> <td data-bbox="783 1016 1412 1182">Allowed values (adding values, AND removals)</td> </tr> <tr> <td data-bbox="608 1189 778 1261">Text</td> <td data-bbox="783 1189 1412 1261">Plain text</td> </tr> <tr> <td data-bbox="608 1267 778 1386">True/False (boolean)</td> <td data-bbox="783 1267 1412 1386">Metric</td> </tr> </tbody> </table> <ul style="list-style-type: none"> ▪ Relation types <ul style="list-style-type: none"> ▪ ID ▪ Description ▪ Role ▪ Co-role ▪ Head asset type <ul style="list-style-type: none"> ▪ ID ▪ Name ▪ Description ▪ Parent asset types, up to the root asset type (for example Business asset) 	Kind	Properties	Multiple selection (Multi value list)	Allowed values <div style="border-left: 2px solid red; padding-left: 5px; background-color: #f0f0f0;"> Warning The list of allowed values is overwritten in the target environment, so it may remove values. </div>	Numeric	<ul style="list-style-type: none"> ▪ Only integers ▪ Metric 	Script	Language. <div style="border-left: 2px solid gray; padding-left: 5px; background-color: #f0f0f0;"> Note This field is only used for validation rule assets. </div>	Selection (single value list)	Allowed values (adding values, AND removals)	Text	Plain text	True/False (boolean)	Metric
Kind	Properties														
Multiple selection (Multi value list)	Allowed values <div style="border-left: 2px solid red; padding-left: 5px; background-color: #f0f0f0;"> Warning The list of allowed values is overwritten in the target environment, so it may remove values. </div>														
Numeric	<ul style="list-style-type: none"> ▪ Only integers ▪ Metric 														
Script	Language. <div style="border-left: 2px solid gray; padding-left: 5px; background-color: #f0f0f0;"> Note This field is only used for validation rule assets. </div>														
Selection (single value list)	Allowed values (adding values, AND removals)														
Text	Plain text														
True/False (boolean)	Metric														

Object	Migrated fields and secondary objects
	<ul style="list-style-type: none"> ▪ Display options <ul style="list-style-type: none"> ▪ Color ▪ Symbol (none, Icon or Code) ▪ Code ▪ Icon reference ▪ displayNameEnabled ▪ ratingsEnabled ▪ Tail asset type <ul style="list-style-type: none"> ▪ ID ▪ Name ▪ Description ▪ Parent asset types, up to the root asset type (for example Business asset) ▪ Display options <ul style="list-style-type: none"> ▪ Color ▪ Symbol (none, Icon or Code) ▪ Code ▪ Icon reference ▪ displayNameEnabled ▪ ratingsEnabled ▪ Complex relation types <ul style="list-style-type: none"> ▪ ID ▪ Name ▪ Description ▪ Display options <ul style="list-style-type: none"> ▪ Color ▪ Symbol (none, Icon or Code) ▪ Code ▪ Icon reference ▪ Attribute types <ul style="list-style-type: none"> ▪ ID ▪ Name ▪ Description ▪ Attribute type kind and its properties

Object	Migrated fields and secondary objects																	
		<table border="1"> <thead> <tr> <th data-bbox="823 331 818 409">Kind</th> <th data-bbox="823 416 1426 409">Properties</th> </tr> </thead> <tbody> <tr> <td data-bbox="823 416 818 488">Date</td> <td data-bbox="823 416 1426 488">None</td> </tr> <tr> <td data-bbox="823 495 818 741">Multiple selection (Multi value list)</td> <td data-bbox="823 495 1426 741"> Allowed values <div style="border-left: 2px solid red; padding-left: 5px; margin-top: 5px;"> Warning The list of allowed values is overwritten in the target environment, so it may remove values. </div> </td> </tr> <tr> <td data-bbox="823 748 818 864">Numeric</td> <td data-bbox="823 748 1426 864"> <ul style="list-style-type: none"> ▪ Only integers ▪ Metric </td> </tr> <tr> <td data-bbox="823 871 818 1088">Script</td> <td data-bbox="823 871 1426 1088"> Language. <div style="border-left: 2px solid gray; padding-left: 5px; margin-top: 5px;"> Note This field is only used for validation rule assets. </div> </td> </tr> <tr> <td data-bbox="823 1095 818 1261">Selection (single value list)</td> <td data-bbox="823 1095 1426 1261">Allowed values (adding values, AND removals)</td> </tr> <tr> <td data-bbox="823 1267 818 1339">Text</td> <td data-bbox="823 1267 1426 1339">Plain text</td> </tr> <tr> <td data-bbox="823 1346 818 1462">True/False (boolean)</td> <td data-bbox="823 1346 1426 1462">Metric</td> </tr> </tbody> </table> <ul style="list-style-type: none"> ▪ Minimum cardinality ▪ Maximum cardinality ▪ Leg types (relation types) <ul style="list-style-type: none"> ▪ Role ▪ Co-role ▪ Asset types that are head or tail of the relation types <ul style="list-style-type: none"> ▪ ID ▪ Name ▪ Description 	Kind	Properties	Date	None	Multiple selection (Multi value list)	Allowed values <div style="border-left: 2px solid red; padding-left: 5px; margin-top: 5px;"> Warning The list of allowed values is overwritten in the target environment, so it may remove values. </div>	Numeric	<ul style="list-style-type: none"> ▪ Only integers ▪ Metric 	Script	Language. <div style="border-left: 2px solid gray; padding-left: 5px; margin-top: 5px;"> Note This field is only used for validation rule assets. </div>	Selection (single value list)	Allowed values (adding values, AND removals)	Text	Plain text	True/False (boolean)	Metric
Kind	Properties																	
Date	None																	
Multiple selection (Multi value list)	Allowed values <div style="border-left: 2px solid red; padding-left: 5px; margin-top: 5px;"> Warning The list of allowed values is overwritten in the target environment, so it may remove values. </div>																	
Numeric	<ul style="list-style-type: none"> ▪ Only integers ▪ Metric 																	
Script	Language. <div style="border-left: 2px solid gray; padding-left: 5px; margin-top: 5px;"> Note This field is only used for validation rule assets. </div>																	
Selection (single value list)	Allowed values (adding values, AND removals)																	
Text	Plain text																	
True/False (boolean)	Metric																	

Object	Migrated fields and secondary objects
	<ul style="list-style-type: none"> ▪ Parent asset types, up to the root asset type (for example Business asset) ▪ Display options <ul style="list-style-type: none"> ▪ Color ▪ Symbol (none, Icon or Code) ▪ Code ▪ Icon reference ▪ displayNameEnabled ▪ ratingsEnabled ▪ Minimum cardinality ▪ Maximum cardinality ○ The domain of the validation rule asset <ul style="list-style-type: none"> ▪ ID ▪ Name ▪ Description ○ The Validation Rule Domain type <ul style="list-style-type: none"> ▪ Parent domain types up to root <ul style="list-style-type: none"> ▪ ID ▪ Name ▪ Description ○ The Validation Rule asset type <ul style="list-style-type: none"> ▪ Parent asset types, up to the root asset type (for example Business asset) ○ The status of the validation rule <ul style="list-style-type: none"> ▪ ID ▪ Name ▪ Description

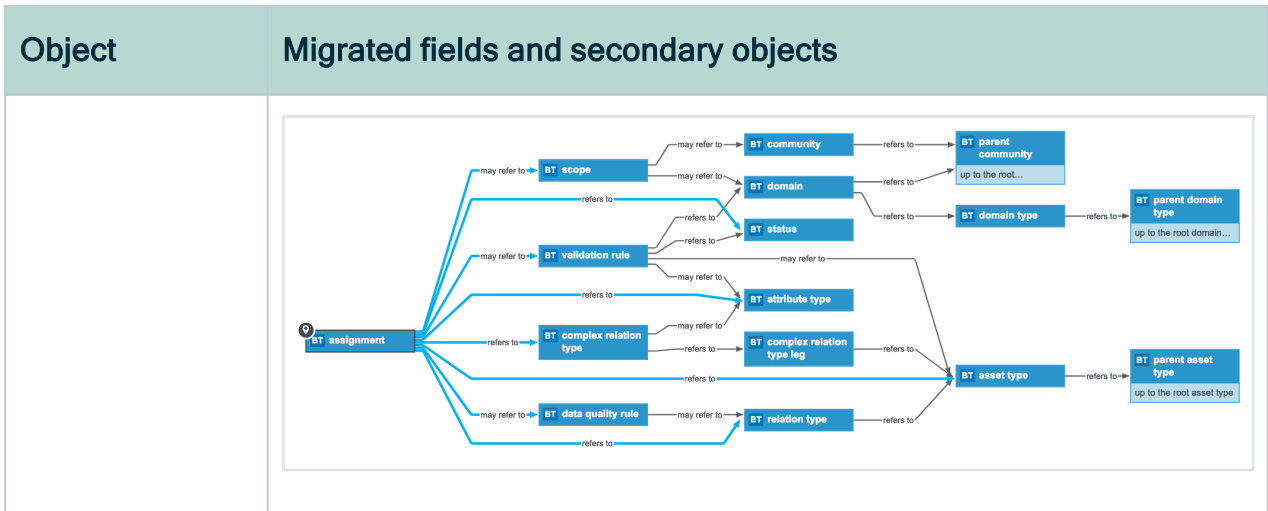

Object	Migrated fields and secondary objects
Attribute	<ul style="list-style-type: none"> • ID • Parent asset <ul style="list-style-type: none"> ◦ Name ◦ ID ◦ Status <ul style="list-style-type: none"> ▪ ID ▪ Name ▪ Description ◦ Parent domain <ul style="list-style-type: none"> ▪ ID ▪ Name ▪ Description ▪ Exclude from Autohyperlinking ▪ Domain type <ul style="list-style-type: none"> ▪ ID ▪ Name ▪ Description ▪ Parent domain types up to root <ul style="list-style-type: none"> ▪ ID ▪ Name ▪ Description ▪ Parent communities, up to the root level <ul style="list-style-type: none"> ▪ ID ▪ Name ▪ Description ◦ Asset type <ul style="list-style-type: none"> ▪ ID ▪ Name ▪ Description ▪ Parent asset types, up to the root asset type (for example Business asset) ▪ Display options <ul style="list-style-type: none"> ▪ Color ▪ Symbol (none, Icon or Code) ▪ Code

Object	Migrated fields and secondary objects																
	<ul style="list-style-type: none"> ▪ Icon reference ▪ displayNameEnabled ▪ ratingsEnabled • Attribute type <ul style="list-style-type: none"> ◦ ID ◦ Name ◦ Description ◦ Attribute type kind and its properties <table border="1" data-bbox="523 701 1414 1805"> <thead> <tr> <th data-bbox="529 710 703 779">Kind</th> <th data-bbox="710 710 1407 779">Properties</th> </tr> </thead> <tbody> <tr> <td data-bbox="529 788 703 857">Date</td> <td data-bbox="710 788 1407 857">None</td> </tr> <tr> <td data-bbox="529 866 703 1077">Multiple selection (Multi value list)</td> <td data-bbox="710 866 1407 1077"> Allowed values <div style="border-left: 2px solid red; padding-left: 10px; background-color: #f0f0f0;"> Warning The list of allowed values is overwritten in the target environment, so it may remove values. </div> </td> </tr> <tr> <td data-bbox="529 1086 703 1196">Numeric</td> <td data-bbox="710 1086 1407 1196"> <ul style="list-style-type: none"> ▪ Only integers ▪ Metric </td> </tr> <tr> <td data-bbox="529 1205 703 1415">Script</td> <td data-bbox="710 1205 1407 1415"> Language. <div style="border-left: 2px solid #ccc; padding-left: 10px; background-color: #f0f0f0;"> Note This field is only used for validation rule assets. </div> </td> </tr> <tr> <td data-bbox="529 1424 703 1592">Selection (single value list)</td> <td data-bbox="710 1424 1407 1592">Allowed values (adding values, AND removals)</td> </tr> <tr> <td data-bbox="529 1601 703 1671">Text</td> <td data-bbox="710 1601 1407 1671">Plain text</td> </tr> <tr> <td data-bbox="529 1680 703 1800">True/False (boolean)</td> <td data-bbox="710 1680 1407 1800">Metric</td> </tr> </tbody> </table> <ul style="list-style-type: none"> • Value(s) 	Kind	Properties	Date	None	Multiple selection (Multi value list)	Allowed values <div style="border-left: 2px solid red; padding-left: 10px; background-color: #f0f0f0;"> Warning The list of allowed values is overwritten in the target environment, so it may remove values. </div>	Numeric	<ul style="list-style-type: none"> ▪ Only integers ▪ Metric 	Script	Language. <div style="border-left: 2px solid #ccc; padding-left: 10px; background-color: #f0f0f0;"> Note This field is only used for validation rule assets. </div>	Selection (single value list)	Allowed values (adding values, AND removals)	Text	Plain text	True/False (boolean)	Metric
Kind	Properties																
Date	None																
Multiple selection (Multi value list)	Allowed values <div style="border-left: 2px solid red; padding-left: 10px; background-color: #f0f0f0;"> Warning The list of allowed values is overwritten in the target environment, so it may remove values. </div>																
Numeric	<ul style="list-style-type: none"> ▪ Only integers ▪ Metric 																
Script	Language. <div style="border-left: 2px solid #ccc; padding-left: 10px; background-color: #f0f0f0;"> Note This field is only used for validation rule assets. </div>																
Selection (single value list)	Allowed values (adding values, AND removals)																
Text	Plain text																
True/False (boolean)	Metric																

Object	Migrated fields and secondary objects																
Attribute type	<ul style="list-style-type: none"> • ID • Name • Description • Attribute type kind and its properties <table border="1" data-bbox="480 517 1417 1585"> <thead> <tr> <th data-bbox="485 517 671 595">Kind</th> <th data-bbox="671 517 1412 595">Properties</th> </tr> </thead> <tbody> <tr> <td data-bbox="485 595 671 669">Date</td> <td data-bbox="671 595 1412 669">None</td> </tr> <tr> <td data-bbox="485 669 671 898">Multiple selection (Multi value list)</td> <td data-bbox="671 669 1412 898"> Allowed values <div style="border-left: 2px solid red; padding-left: 10px; background-color: #f0f0f0;">Warning The list of allowed values is overwritten in the target environment, so it may remove values.</div> </td> </tr> <tr> <td data-bbox="485 898 671 1010">Numeric</td> <td data-bbox="671 898 1412 1010"> <ul style="list-style-type: none"> ◦ Only integers ◦ Metric </td> </tr> <tr> <td data-bbox="485 1010 671 1205">Script</td> <td data-bbox="671 1010 1412 1205"> Language. <div style="border-left: 2px solid gray; padding-left: 10px; background-color: #f0f0f0;">Note This field is only used for validation rule assets.</div> </td> </tr> <tr> <td data-bbox="485 1205 671 1379">Selection (single value list)</td> <td data-bbox="671 1205 1412 1379">Allowed values (adding values, AND removals)</td> </tr> <tr> <td data-bbox="485 1379 671 1453">Text</td> <td data-bbox="671 1379 1412 1453">Plain text</td> </tr> <tr> <td data-bbox="485 1453 671 1585">True/False (boolean)</td> <td data-bbox="671 1453 1412 1585">Metric</td> </tr> </tbody> </table>	Kind	Properties	Date	None	Multiple selection (Multi value list)	Allowed values <div style="border-left: 2px solid red; padding-left: 10px; background-color: #f0f0f0;">Warning The list of allowed values is overwritten in the target environment, so it may remove values.</div>	Numeric	<ul style="list-style-type: none"> ◦ Only integers ◦ Metric 	Script	Language. <div style="border-left: 2px solid gray; padding-left: 10px; background-color: #f0f0f0;">Note This field is only used for validation rule assets.</div>	Selection (single value list)	Allowed values (adding values, AND removals)	Text	Plain text	True/False (boolean)	Metric
Kind	Properties																
Date	None																
Multiple selection (Multi value list)	Allowed values <div style="border-left: 2px solid red; padding-left: 10px; background-color: #f0f0f0;">Warning The list of allowed values is overwritten in the target environment, so it may remove values.</div>																
Numeric	<ul style="list-style-type: none"> ◦ Only integers ◦ Metric 																
Script	Language. <div style="border-left: 2px solid gray; padding-left: 10px; background-color: #f0f0f0;">Note This field is only used for validation rule assets.</div>																
Selection (single value list)	Allowed values (adding values, AND removals)																
Text	Plain text																
True/False (boolean)	Metric																
Community	<ul style="list-style-type: none"> • ID • Name • Description • Parent communities, up to the root level <ul style="list-style-type: none"> ◦ ID ◦ Name ◦ Description 																

Object	Migrated fields and secondary objects														
Complex relation type	<ul style="list-style-type: none"> • ID • Name • Description • Display options <ul style="list-style-type: none"> ◦ Color ◦ Symbol (none, Icon or Code) ◦ Code ◦ Icon reference • Attribute types <ul style="list-style-type: none"> ◦ ID ◦ Name ◦ Description ◦ Attribute type kind and its properties <table border="1" data-bbox="523 931 1417 1899"> <thead> <tr> <th data-bbox="523 931 703 1003">Kind</th> <th data-bbox="703 931 1417 1003">Properties</th> </tr> </thead> <tbody> <tr> <td data-bbox="523 1003 703 1081">Date</td> <td data-bbox="703 1003 1417 1081">None</td> </tr> <tr> <td data-bbox="523 1081 703 1308">Multiple selection (Multi value list)</td> <td data-bbox="703 1081 1417 1308"> Allowed values <div style="border-left: 2px solid red; padding-left: 10px; margin-top: 5px;"> Warning The list of allowed values is overwritten in the target environment, so it may remove values. </div> </td> </tr> <tr> <td data-bbox="523 1308 703 1424">Numeric</td> <td data-bbox="703 1308 1417 1424"> <ul style="list-style-type: none"> ▪ Only integers ▪ Metric </td> </tr> <tr> <td data-bbox="523 1424 703 1650">Script</td> <td data-bbox="703 1424 1417 1650"> Language. <div style="border-left: 2px solid gray; padding-left: 10px; margin-top: 5px;"> Note This field is only used for validation rule assets. </div> </td> </tr> <tr> <td data-bbox="523 1650 703 1825">Selection (single value list)</td> <td data-bbox="703 1650 1417 1825">Allowed values (adding values, AND removals)</td> </tr> <tr> <td data-bbox="523 1825 703 1899">Text</td> <td data-bbox="703 1825 1417 1899">Plain text</td> </tr> </tbody> </table>	Kind	Properties	Date	None	Multiple selection (Multi value list)	Allowed values <div style="border-left: 2px solid red; padding-left: 10px; margin-top: 5px;"> Warning The list of allowed values is overwritten in the target environment, so it may remove values. </div>	Numeric	<ul style="list-style-type: none"> ▪ Only integers ▪ Metric 	Script	Language. <div style="border-left: 2px solid gray; padding-left: 10px; margin-top: 5px;"> Note This field is only used for validation rule assets. </div>	Selection (single value list)	Allowed values (adding values, AND removals)	Text	Plain text
Kind	Properties														
Date	None														
Multiple selection (Multi value list)	Allowed values <div style="border-left: 2px solid red; padding-left: 10px; margin-top: 5px;"> Warning The list of allowed values is overwritten in the target environment, so it may remove values. </div>														
Numeric	<ul style="list-style-type: none"> ▪ Only integers ▪ Metric 														
Script	Language. <div style="border-left: 2px solid gray; padding-left: 10px; margin-top: 5px;"> Note This field is only used for validation rule assets. </div>														
Selection (single value list)	Allowed values (adding values, AND removals)														
Text	Plain text														

Object	Migrated fields and secondary objects				
	<table border="1" data-bbox="523 331 1417 542"> <thead> <tr> <th data-bbox="523 331 703 409">Kind</th> <th data-bbox="703 331 1417 409">Properties</th> </tr> </thead> <tbody> <tr> <td data-bbox="523 409 703 542">True/False (boolean)</td> <td data-bbox="703 409 1417 542">Metric</td> </tr> </tbody> </table> <ul style="list-style-type: none"> ◦ Minimum cardinality ◦ Maximum cardinality • Leg types (relation types) <ul style="list-style-type: none"> ◦ Role ◦ Co-role ◦ Asset types that are head or tail of the relation types <ul style="list-style-type: none"> ▪ ID ▪ Name ▪ Description ▪ Parent asset types, up to the root asset type (for example Business asset) ▪ Display options <ul style="list-style-type: none"> ▪ Color ▪ Symbol (none, Icon or Code) ▪ Code ▪ Icon reference ▪ displayNameEnabled ▪ ratingsEnabled ◦ Minimum cardinality ◦ Maximum cardinality 	Kind	Properties	True/False (boolean)	Metric
Kind	Properties				
True/False (boolean)	Metric				

Object	Migrated fields and secondary objects
Data quality rule	<ul style="list-style-type: none"> • ID • Name • Description • Aggregation path <ul style="list-style-type: none"> ◦ Relation trace entries (path): The sequence of relation types and their direction <ul style="list-style-type: none"> ▪ ID ▪ Description ▪ Role ▪ Co-role ▪ Head asset type <ul style="list-style-type: none"> ▪ ID ▪ Name ▪ Description ▪ Parent asset types, up to the root asset type (for example Business asset) ▪ Display options <ul style="list-style-type: none"> ▪ Color ▪ Symbol (none, Icon or Code) ▪ Code ▪ Icon reference ▪ displayNameEnabled ▪ ratingsEnabled ▪ Tail asset type <ul style="list-style-type: none"> ▪ ID ▪ Name ▪ Description ▪ Parent asset types, up to the root asset type (for example Business asset) ▪ Display options <ul style="list-style-type: none"> ▪ Color ▪ Symbol (none, Icon or Code) ▪ Code ▪ Icon reference ▪ displayNameEnabled

Object	Migrated fields and secondary objects
	<ul style="list-style-type: none"> ▪ ratingsEnabled ○ Categorization relation types <ul style="list-style-type: none"> ▪ ID ▪ Description ▪ Role ▪ Co-role ▪ Head asset type <ul style="list-style-type: none"> ▪ ID ▪ Name ▪ Description ▪ Parent asset types, up to the root asset type (for example Business asset) ▪ Display options <ul style="list-style-type: none"> ▪ Color ▪ Symbol (none, Icon or Code) ▪ Code ▪ Icon reference ▪ displayNameEnabled ▪ ratingsEnabled ▪ Tail asset type <ul style="list-style-type: none"> ▪ ID ▪ Name ▪ Description ▪ Parent asset types, up to the root asset type (for example Business asset) ▪ Display options <ul style="list-style-type: none"> ▪ Color ▪ Symbol (none, Icon or Code) ▪ Code ▪ Icon reference ▪ displayNameEnabled ▪ ratingsEnabled • Data Quality Metrics: attribute types of the Metric attribute type kind <ul style="list-style-type: none"> ○ ID

Object	Migrated fields and secondary objects																
	<ul style="list-style-type: none"> ◦ Name ◦ Description ◦ Attribute type kind and its properties <table border="1" data-bbox="523 472 1417 1574"> <thead> <tr> <th data-bbox="523 472 703 548">Kind</th> <th data-bbox="703 472 1417 548">Properties</th> </tr> </thead> <tbody> <tr> <td data-bbox="523 548 703 622">Date</td> <td data-bbox="703 548 1417 622">None</td> </tr> <tr> <td data-bbox="523 622 703 846">Multiple selection (Multi value list)</td> <td data-bbox="703 622 1417 846"> Allowed values <div style="border-left: 2px solid red; padding-left: 10px; background-color: #f0f0f0;">Warning The list of allowed values is overwritten in the target environment, so it may remove values.</div> </td> </tr> <tr> <td data-bbox="523 846 703 965">Numeric</td> <td data-bbox="703 846 1417 965"> <ul style="list-style-type: none"> ▪ Only integers ▪ Metric </td> </tr> <tr> <td data-bbox="523 965 703 1189">Script</td> <td data-bbox="703 965 1417 1189"> Language. <div style="border-left: 2px solid gray; padding-left: 10px; background-color: #f0f0f0;">Note This field is only used for validation rule assets.</div> </td> </tr> <tr> <td data-bbox="523 1189 703 1361">Selection (single value list)</td> <td data-bbox="703 1189 1417 1361">Allowed values (adding values, AND removals)</td> </tr> <tr> <td data-bbox="523 1361 703 1435">Text</td> <td data-bbox="703 1361 1417 1435">Plain text</td> </tr> <tr> <td data-bbox="523 1435 703 1574">True/False (boolean)</td> <td data-bbox="703 1435 1417 1574">Metric</td> </tr> </tbody> </table>	Kind	Properties	Date	None	Multiple selection (Multi value list)	Allowed values <div style="border-left: 2px solid red; padding-left: 10px; background-color: #f0f0f0;">Warning The list of allowed values is overwritten in the target environment, so it may remove values.</div>	Numeric	<ul style="list-style-type: none"> ▪ Only integers ▪ Metric 	Script	Language. <div style="border-left: 2px solid gray; padding-left: 10px; background-color: #f0f0f0;">Note This field is only used for validation rule assets.</div>	Selection (single value list)	Allowed values (adding values, AND removals)	Text	Plain text	True/False (boolean)	Metric
Kind	Properties																
Date	None																
Multiple selection (Multi value list)	Allowed values <div style="border-left: 2px solid red; padding-left: 10px; background-color: #f0f0f0;">Warning The list of allowed values is overwritten in the target environment, so it may remove values.</div>																
Numeric	<ul style="list-style-type: none"> ▪ Only integers ▪ Metric 																
Script	Language. <div style="border-left: 2px solid gray; padding-left: 10px; background-color: #f0f0f0;">Note This field is only used for validation rule assets.</div>																
Selection (single value list)	Allowed values (adding values, AND removals)																
Text	Plain text																
True/False (boolean)	Metric																

Object	Migrated fields and secondary objects
Domain	<ul style="list-style-type: none"> • ID • Name • Description • Exclude from Autohyperlinking • Domain type <ul style="list-style-type: none"> ◦ ID ◦ Name ◦ Description ◦ Parent domain types up to root <ul style="list-style-type: none"> ▪ ID ▪ Name ▪ Description • Parent communities, up to the root level <ul style="list-style-type: none"> ◦ ID ◦ Name ◦ Description
Domain type	<ul style="list-style-type: none"> • ID • Name • Description • Parent domain types up to root <ul style="list-style-type: none"> ◦ ID ◦ Name ◦ Description

Object	Migrated fields and secondary objects
Relation type	<ul style="list-style-type: none"> • ID • Description • Role • Co-role • Head asset type <ul style="list-style-type: none"> ◦ ID ◦ Name ◦ Description ◦ Parent asset types, up to the root asset type (for example Business asset) ◦ Display options <ul style="list-style-type: none"> ▪ Color ▪ Symbol (none, Icon or Code) ▪ Code ▪ Icon reference ◦ displayNameEnabled ◦ ratingsEnabled • Tail asset type <ul style="list-style-type: none"> ◦ ID ◦ Name ◦ Description ◦ Parent asset types, up to the root asset type (for example Business asset) ◦ Display options <ul style="list-style-type: none"> ▪ Color ▪ Symbol (none, Icon or Code) ▪ Code ▪ Icon reference ◦ displayNameEnabled ◦ ratingsEnabled

Object	Migrated fields and secondary objects
Roles	<ul style="list-style-type: none">• No secondary objects• ID• Name• Description• Global• Permissions

Object	Migrated fields and secondary objects
Scope	<ul style="list-style-type: none"> • ID • Name • Description • Communities <ul style="list-style-type: none"> ◦ ID ◦ Name ◦ Description ◦ Parent communities, up to the root level <ul style="list-style-type: none"> ▪ ID ▪ Name ▪ Description <div style="background-color: #f0f0f0; padding: 10px; margin: 10px 0;"> <p>Note</p> <ul style="list-style-type: none"> ◦ If the scope contains an entire community that contains subcommunities and domains, the subcommunities and domains are not included. ◦ If domains or communities are included in the scope, their parent communities will be included too. Other children of its parent community will not be included, unless they are also in the scope. ◦ The domain type of the included domains are also included. </div> <ul style="list-style-type: none"> • Domains <ul style="list-style-type: none"> ◦ ID ◦ Name ◦ Description ◦ Exclude from Autohyperlinking ◦ Domain type <ul style="list-style-type: none"> ▪ ID ▪ Name ▪ Description ▪ Parent domain types up to root <ul style="list-style-type: none"> ▪ ID ▪ Name ▪ Description

Object	Migrated fields and secondary objects
	<ul style="list-style-type: none">◦ Parent communities, up to the root level<ul style="list-style-type: none">▪ ID▪ Name▪ Description
Status	<ul style="list-style-type: none">• ID• Name• Description

Object	Migrated fields and secondary objects																
Validation rule	<ul style="list-style-type: none"> • Name • ID • Characteristic types that are referenced in the validation script <ul style="list-style-type: none"> ◦ Attribute types <ul style="list-style-type: none"> ▪ ID ▪ Name ▪ Description ▪ Attribute type kind and its properties <table border="1" data-bbox="563 701 1417 1839"> <thead> <tr> <th data-bbox="563 701 740 779">Kind</th> <th data-bbox="740 701 1417 779">Properties</th> </tr> </thead> <tbody> <tr> <td data-bbox="563 779 740 853">Date</td> <td data-bbox="740 779 1417 853">None</td> </tr> <tr> <td data-bbox="563 853 740 1115">Multiple selection (Multi value list)</td> <td data-bbox="740 853 1417 1115"> Allowed values <div style="border-left: 2px solid red; padding-left: 10px; background-color: #f0f0f0;">Warning The list of allowed values is overwritten in the target environment, so it may remove values.</div> </td> </tr> <tr> <td data-bbox="563 1115 740 1227">Numeric</td> <td data-bbox="740 1115 1417 1227"> <ul style="list-style-type: none"> ▪ Only integers ▪ Metric </td> </tr> <tr> <td data-bbox="563 1227 740 1451">Script</td> <td data-bbox="740 1227 1417 1451"> Language. <div style="border-left: 2px solid gray; padding-left: 10px; background-color: #f0f0f0;">Note This field is only used for validation rule assets.</div> </td> </tr> <tr> <td data-bbox="563 1451 740 1630">Selection (single value list)</td> <td data-bbox="740 1451 1417 1630">Allowed values (adding values, AND removals)</td> </tr> <tr> <td data-bbox="563 1630 740 1704">Text</td> <td data-bbox="740 1630 1417 1704">Plain text</td> </tr> <tr> <td data-bbox="563 1704 740 1839">True/False (boolean)</td> <td data-bbox="740 1704 1417 1839">Metric</td> </tr> </tbody> </table> ◦ Relation types <ul style="list-style-type: none"> ▪ ID 	Kind	Properties	Date	None	Multiple selection (Multi value list)	Allowed values <div style="border-left: 2px solid red; padding-left: 10px; background-color: #f0f0f0;">Warning The list of allowed values is overwritten in the target environment, so it may remove values.</div>	Numeric	<ul style="list-style-type: none"> ▪ Only integers ▪ Metric 	Script	Language. <div style="border-left: 2px solid gray; padding-left: 10px; background-color: #f0f0f0;">Note This field is only used for validation rule assets.</div>	Selection (single value list)	Allowed values (adding values, AND removals)	Text	Plain text	True/False (boolean)	Metric
Kind	Properties																
Date	None																
Multiple selection (Multi value list)	Allowed values <div style="border-left: 2px solid red; padding-left: 10px; background-color: #f0f0f0;">Warning The list of allowed values is overwritten in the target environment, so it may remove values.</div>																
Numeric	<ul style="list-style-type: none"> ▪ Only integers ▪ Metric 																
Script	Language. <div style="border-left: 2px solid gray; padding-left: 10px; background-color: #f0f0f0;">Note This field is only used for validation rule assets.</div>																
Selection (single value list)	Allowed values (adding values, AND removals)																
Text	Plain text																
True/False (boolean)	Metric																

Object	Migrated fields and secondary objects
	<ul style="list-style-type: none"> ▪ Description ▪ Role ▪ Co-role ▪ Head asset type <ul style="list-style-type: none"> ▪ ID ▪ Name ▪ Description ▪ Parent asset types, up to the root asset type (for example Business asset) ▪ Display options <ul style="list-style-type: none"> ▪ Color ▪ Symbol (none, Icon or Code) ▪ Code ▪ Icon reference ▪ displayNameEnabled ▪ ratingsEnabled ▪ Tail asset type <ul style="list-style-type: none"> ▪ ID ▪ Name ▪ Description ▪ Parent asset types, up to the root asset type (for example Business asset) ▪ Display options <ul style="list-style-type: none"> ▪ Color ▪ Symbol (none, Icon or Code) ▪ Code ▪ Icon reference ▪ displayNameEnabled ▪ ratingsEnabled ○ Complex relation types <ul style="list-style-type: none"> ▪ ID ▪ Name ▪ Description ▪ Display options <ul style="list-style-type: none"> ▪ Color

Object	Migrated fields and secondary objects																
	<ul style="list-style-type: none"> ▪ Symbol (none, Icon or Code) ▪ Code ▪ Icon reference ▪ Attribute types <ul style="list-style-type: none"> ▪ ID ▪ Name ▪ Description ▪ Attribute type kind and its properties <table border="1" data-bbox="603 701 1417 1839"> <thead> <tr> <th data-bbox="603 701 778 779">Kind</th> <th data-bbox="778 701 1417 779">Properties</th> </tr> </thead> <tbody> <tr> <td data-bbox="603 779 778 853">Date</td> <td data-bbox="778 779 1417 853">None</td> </tr> <tr> <td data-bbox="603 853 778 1115">Multiple selection (Multi value list)</td> <td data-bbox="778 853 1417 1115"> Allowed values <div style="border-left: 2px solid red; padding-left: 10px; background-color: #f0f0f0;"> Warning The list of allowed values is overwritten in the target environment, so it may remove values. </div> </td> </tr> <tr> <td data-bbox="603 1115 778 1234">Numeric</td> <td data-bbox="778 1115 1417 1234"> <ul style="list-style-type: none"> ▪ Only integers ▪ Metric </td> </tr> <tr> <td data-bbox="603 1234 778 1458">Script</td> <td data-bbox="778 1234 1417 1458"> Language. <div style="border-left: 2px solid gray; padding-left: 10px; background-color: #f0f0f0;"> Note This field is only used for validation rule assets. </div> </td> </tr> <tr> <td data-bbox="603 1458 778 1630">Selection (single value list)</td> <td data-bbox="778 1458 1417 1630">Allowed values (adding values, AND removals)</td> </tr> <tr> <td data-bbox="603 1630 778 1704">Text</td> <td data-bbox="778 1630 1417 1704">Plain text</td> </tr> <tr> <td data-bbox="603 1704 778 1839">True/False (boolean)</td> <td data-bbox="778 1704 1417 1839">Metric</td> </tr> </tbody> </table> <ul style="list-style-type: none"> ▪ Minimum cardinality ▪ Maximum cardinality 	Kind	Properties	Date	None	Multiple selection (Multi value list)	Allowed values <div style="border-left: 2px solid red; padding-left: 10px; background-color: #f0f0f0;"> Warning The list of allowed values is overwritten in the target environment, so it may remove values. </div>	Numeric	<ul style="list-style-type: none"> ▪ Only integers ▪ Metric 	Script	Language. <div style="border-left: 2px solid gray; padding-left: 10px; background-color: #f0f0f0;"> Note This field is only used for validation rule assets. </div>	Selection (single value list)	Allowed values (adding values, AND removals)	Text	Plain text	True/False (boolean)	Metric
Kind	Properties																
Date	None																
Multiple selection (Multi value list)	Allowed values <div style="border-left: 2px solid red; padding-left: 10px; background-color: #f0f0f0;"> Warning The list of allowed values is overwritten in the target environment, so it may remove values. </div>																
Numeric	<ul style="list-style-type: none"> ▪ Only integers ▪ Metric 																
Script	Language. <div style="border-left: 2px solid gray; padding-left: 10px; background-color: #f0f0f0;"> Note This field is only used for validation rule assets. </div>																
Selection (single value list)	Allowed values (adding values, AND removals)																
Text	Plain text																
True/False (boolean)	Metric																

Object	Migrated fields and secondary objects
	<ul style="list-style-type: none"> ▪ Leg types (relation types) <ul style="list-style-type: none"> ▪ Role ▪ Co-role ▪ Asset types that are head or tail of the relation types <ul style="list-style-type: none"> ▪ ID ▪ Name ▪ Description ▪ Parent asset types, up to the root asset type (for example Business asset) ▪ Display options <ul style="list-style-type: none"> ▪ Color ▪ Symbol (none, Icon or Code) ▪ Code ▪ Icon reference ▪ displayNameEnabled ▪ ratingsEnabled ▪ Minimum cardinality ▪ Maximum cardinality • The parent domain of the validation rule asset <ul style="list-style-type: none"> ◦ ▪ ID ▪ Name ▪ Description • The Validation Rule Domain type <ul style="list-style-type: none"> ◦ Parent domain types up to root <ul style="list-style-type: none"> ▪ ID ▪ Name ▪ Description • The Validation Rule asset type <ul style="list-style-type: none"> ◦ Parent asset types, up to the root asset type (for example Business asset) • The status of the validation rule <ul style="list-style-type: none"> ◦ ID ◦ Name ◦ Description

Object	Migrated fields and secondary objects
Workflow	<ul style="list-style-type: none"> • Name • Description • Status • Assignment rules (Applies To section) <ul style="list-style-type: none"> ◦ Asset types <ul style="list-style-type: none"> ▪ ID ▪ Name ▪ Description ▪ Parent asset types, up to the root asset type (for example Business asset) ▪ Display options <ul style="list-style-type: none"> ▪ Color ▪ Symbol (none, Icon or Code) ▪ Code ▪ Icon reference ▪ displayNameEnabled ▪ ratingsEnabled ◦ Communities <ul style="list-style-type: none"> ▪ ID ▪ Name ▪ Description ▪ Parent communities, up to the root level <ul style="list-style-type: none"> ▪ ID ▪ Name ▪ Description ◦ Domains <ul style="list-style-type: none"> ▪ ID ▪ Name ▪ Description ▪ Exclude from Autohyperlinking ▪ Domain type <ul style="list-style-type: none"> ▪ ID ▪ Name ▪ Description ▪ Parent domain types up to root

Object	Migrated fields and secondary objects				
	<ul style="list-style-type: none"> ▪ ID ▪ Name ▪ Description ▪ Parent communities, up to the root level <ul style="list-style-type: none"> ▪ ID ▪ Name ▪ Description • Is Global Create • Start label • Configuration variables <ul style="list-style-type: none"> ◦ Asset types <ul style="list-style-type: none"> ▪ ID ▪ Name ▪ Description ▪ Parent asset types, up to the root asset type (for example Business asset) ▪ Display options <ul style="list-style-type: none"> ▪ Color ▪ Symbol (none, Icon or Code) ▪ Code ▪ Icon reference ▪ displayNameEnabled ▪ ratingsEnabled ◦ Characteristic types <ul style="list-style-type: none"> ▪ Attribute types <ul style="list-style-type: none"> ▪ ID ▪ Name ▪ Description ▪ Attribute type kind and its properties <table border="1" data-bbox="603 1666 1414 1816"> <thead> <tr> <th data-bbox="609 1675 778 1742">Kind</th> <th data-bbox="785 1675 1407 1742">Properties</th> </tr> </thead> <tbody> <tr> <td data-bbox="609 1751 778 1809">Date</td> <td data-bbox="785 1751 1407 1809">None</td> </tr> </tbody> </table>	Kind	Properties	Date	None
Kind	Properties				
Date	None				

Object	Migrated fields and secondary objects														
	<table border="1" data-bbox="603 331 1417 1393"> <thead> <tr> <th data-bbox="608 338 778 409">Kind</th> <th data-bbox="783 338 1412 409">Properties</th> </tr> </thead> <tbody> <tr> <td data-bbox="608 416 778 667">Multiple selection (Multi value list)</td> <td data-bbox="783 416 1412 667"> Allowed values <div style="border-left: 2px solid red; padding-left: 5px; background-color: #f0f0f0;"> Warning The list of allowed values is overwritten in the target environment, so it may remove values. </div> </td> </tr> <tr> <td data-bbox="608 674 778 786">Numeric</td> <td data-bbox="783 674 1412 786"> <ul style="list-style-type: none"> ▪ Only integers ▪ Metric </td> </tr> <tr> <td data-bbox="608 792 778 1010">Script</td> <td data-bbox="783 792 1412 1010"> Language. <div style="border-left: 2px solid gray; padding-left: 5px; background-color: #f0f0f0;"> Note This field is only used for validation rule assets. </div> </td> </tr> <tr> <td data-bbox="608 1016 778 1182">Selection (single value list)</td> <td data-bbox="783 1016 1412 1182">Allowed values (adding values, AND removals)</td> </tr> <tr> <td data-bbox="608 1189 778 1261">Text</td> <td data-bbox="783 1189 1412 1261">Plain text</td> </tr> <tr> <td data-bbox="608 1267 778 1386">True/False (boolean)</td> <td data-bbox="783 1267 1412 1386">Metric</td> </tr> </tbody> </table> <ul style="list-style-type: none"> ▪ Relation types <ul style="list-style-type: none"> ▪ ID ▪ Description ▪ Role ▪ Co-role ▪ Head asset type <ul style="list-style-type: none"> ▪ ID ▪ Name ▪ Description ▪ Parent asset types, up to the root asset type (for example Business asset) 	Kind	Properties	Multiple selection (Multi value list)	Allowed values <div style="border-left: 2px solid red; padding-left: 5px; background-color: #f0f0f0;"> Warning The list of allowed values is overwritten in the target environment, so it may remove values. </div>	Numeric	<ul style="list-style-type: none"> ▪ Only integers ▪ Metric 	Script	Language. <div style="border-left: 2px solid gray; padding-left: 5px; background-color: #f0f0f0;"> Note This field is only used for validation rule assets. </div>	Selection (single value list)	Allowed values (adding values, AND removals)	Text	Plain text	True/False (boolean)	Metric
Kind	Properties														
Multiple selection (Multi value list)	Allowed values <div style="border-left: 2px solid red; padding-left: 5px; background-color: #f0f0f0;"> Warning The list of allowed values is overwritten in the target environment, so it may remove values. </div>														
Numeric	<ul style="list-style-type: none"> ▪ Only integers ▪ Metric 														
Script	Language. <div style="border-left: 2px solid gray; padding-left: 5px; background-color: #f0f0f0;"> Note This field is only used for validation rule assets. </div>														
Selection (single value list)	Allowed values (adding values, AND removals)														
Text	Plain text														
True/False (boolean)	Metric														

Object	Migrated fields and secondary objects
	<ul style="list-style-type: none"> ▪ Display options <ul style="list-style-type: none"> ▪ Color ▪ Symbol (none, Icon or Code) ▪ Code ▪ Icon reference ▪ displayNameEnabled ▪ ratingsEnabled ▪ Tail asset type <ul style="list-style-type: none"> ▪ ID ▪ Name ▪ Description ▪ Parent asset types, up to the root asset type (for example Business asset) ▪ Display options <ul style="list-style-type: none"> ▪ Color ▪ Symbol (none, Icon or Code) ▪ Code ▪ Icon reference ▪ displayNameEnabled ▪ ratingsEnabled ▪ Complex relation types <ul style="list-style-type: none"> ▪ ID ▪ Name ▪ Description ▪ Display options <ul style="list-style-type: none"> ▪ Color ▪ Symbol (none, Icon or Code) ▪ Code ▪ Icon reference ▪ Attribute types <ul style="list-style-type: none"> ▪ ID ▪ Name ▪ Description ▪ Attribute type kind and its properties

Object	Migrated fields and secondary objects																	
		<table border="1"> <thead> <tr> <th data-bbox="823 331 818 409">Kind</th> <th data-bbox="823 416 1426 409">Properties</th> </tr> </thead> <tbody> <tr> <td data-bbox="823 416 818 488">Date</td> <td data-bbox="823 416 1426 488">None</td> </tr> <tr> <td data-bbox="823 495 818 741">Multiple selection (Multi value list)</td> <td data-bbox="823 495 1426 741"> Allowed values <div style="border-left: 2px solid red; padding-left: 10px; margin-top: 5px;"> Warning The list of allowed values is overwritten in the target environment, so it may remove values. </div> </td> </tr> <tr> <td data-bbox="823 748 818 864">Numeric</td> <td data-bbox="823 748 1426 864"> <ul style="list-style-type: none"> ▪ Only integers ▪ Metric </td> </tr> <tr> <td data-bbox="823 871 818 1088">Script</td> <td data-bbox="823 871 1426 1088"> Language. <div style="border-left: 2px solid gray; padding-left: 10px; margin-top: 5px;"> Note This field is only used for validation rule assets. </div> </td> </tr> <tr> <td data-bbox="823 1095 818 1261">Selection (single value list)</td> <td data-bbox="823 1095 1426 1261">Allowed values (adding values, AND removals)</td> </tr> <tr> <td data-bbox="823 1267 818 1339">Text</td> <td data-bbox="823 1267 1426 1339">Plain text</td> </tr> <tr> <td data-bbox="823 1346 818 1462">True/False (boolean)</td> <td data-bbox="823 1346 1426 1462">Metric</td> </tr> </tbody> </table> <ul style="list-style-type: none"> ▪ Minimum cardinality ▪ Maximum cardinality ▪ Leg types (relation types) <ul style="list-style-type: none"> ▪ Role ▪ Co-role ▪ Asset types that are head or tail of the relation types <ul style="list-style-type: none"> ▪ ID ▪ Name ▪ Description 	Kind	Properties	Date	None	Multiple selection (Multi value list)	Allowed values <div style="border-left: 2px solid red; padding-left: 10px; margin-top: 5px;"> Warning The list of allowed values is overwritten in the target environment, so it may remove values. </div>	Numeric	<ul style="list-style-type: none"> ▪ Only integers ▪ Metric 	Script	Language. <div style="border-left: 2px solid gray; padding-left: 10px; margin-top: 5px;"> Note This field is only used for validation rule assets. </div>	Selection (single value list)	Allowed values (adding values, AND removals)	Text	Plain text	True/False (boolean)	Metric
Kind	Properties																	
Date	None																	
Multiple selection (Multi value list)	Allowed values <div style="border-left: 2px solid red; padding-left: 10px; margin-top: 5px;"> Warning The list of allowed values is overwritten in the target environment, so it may remove values. </div>																	
Numeric	<ul style="list-style-type: none"> ▪ Only integers ▪ Metric 																	
Script	Language. <div style="border-left: 2px solid gray; padding-left: 10px; margin-top: 5px;"> Note This field is only used for validation rule assets. </div>																	
Selection (single value list)	Allowed values (adding values, AND removals)																	
Text	Plain text																	
True/False (boolean)	Metric																	

Object	Migrated fields and secondary objects
	<ul style="list-style-type: none"> ▪ Parent asset types, up to the root asset type (for example Business asset) ▪ Display options <ul style="list-style-type: none"> ▪ Color ▪ Symbol (none, Icon or Code) ▪ Code ▪ Icon reference ▪ displayNameEnabled ▪ ratingsEnabled ▪ Minimum cardinality ▪ Maximum cardinality ○ Communities <ul style="list-style-type: none"> ▪ ID ▪ Name ▪ Description ▪ Parent communities, up to the root level <ul style="list-style-type: none"> ▪ ID ▪ Name ▪ Description ○ Domains <ul style="list-style-type: none"> ▪ ID ▪ Name ▪ Description ▪ Exclude from Autohyperlinking ▪ Domain type <ul style="list-style-type: none"> ▪ ID ▪ Name ▪ Description ▪ Parent domain types up to root <ul style="list-style-type: none"> ▪ ID ▪ Name ▪ Description ▪ Parent communities, up to the root level <ul style="list-style-type: none"> ▪ ID ▪ Name

Object	Migrated fields and secondary objects
	<ul style="list-style-type: none"> <ul style="list-style-type: none"> <ul style="list-style-type: none"> ■ Description ○ Roles ○ Status <ul style="list-style-type: none"> ■ ID ■ Name ■ Description • Business Item object type (i.e. Global vs Asset) • Roles allowed to start • Roles allowed to stop • Roles allowed to reassign • Start events • Exclusivity • Candidate user check disabled • Guest user accessibility • Registered user accessibility • Process ID • Workflow XML • Flowable forms <div data-bbox="443 1187 1417 1568" style="border: 1px solid #ccc; padding: 10px; margin-top: 20px;"> </div>
<p>Navigation objects</p>	

Object	Migrated fields and secondary objects
Table view	<ul style="list-style-type: none">• ID• Name• Description• Configuration• Is preferred• Is default• Sharing rules• Assignment rules

Object	Migrated fields and secondary objects
Dashboard	<p>Any field referenced in a template of a widget:</p> <ul style="list-style-type: none"> • ID • Name • Asset types <ul style="list-style-type: none"> ◦ ID ◦ Name ◦ Description ◦ Parent asset types, up to the root asset type (for example Business asset) ◦ Display options <ul style="list-style-type: none"> ▪ Color ▪ Symbol (none, Icon or Code) ▪ Code ▪ Icon reference ◦ displayNameEnabled ◦ ratingsEnabled • Communities <ul style="list-style-type: none"> ◦ ID ◦ Name ◦ Description ◦ Parent communities, up to the root level <ul style="list-style-type: none"> ▪ ID ▪ Name ▪ Description • Domains <ul style="list-style-type: none"> ◦ ID ◦ Name ◦ Description ◦ Exclude from Autohyperlinking ◦ Domain type <ul style="list-style-type: none"> ▪ ID ▪ Name ▪ Description ▪ Parent domain types up to root

Object	Migrated fields and secondary objects
	<ul style="list-style-type: none"> ▪ ID ▪ Name ▪ Description ○ Parent communities, up to the root level <ul style="list-style-type: none"> ▪ ID ▪ Name ▪ Description • Roles • Status <ul style="list-style-type: none"> ○ ID ○ Name ○ Description <div data-bbox="443 913 1417 1249" style="border: 1px solid #ccc; padding: 10px; margin-top: 10px;"> <pre> graph LR BT_dashboard[BT dashboard] -- "may refer to" --> BT_global_role[BT global role] BT_dashboard -- "may refer to" --> BT_community[BT community] BT_dashboard -- "may refer to" --> BT_domain[BT domain] BT_dashboard -- "may refer to" --> BT_status[BT status] BT_dashboard -- "may refer to" --> BT_asset_type[BT asset type] BT_community -- "refers to" --> BT_parent_community[BT parent community up to the root...] BT_domain -- "refers to" --> BT_parent_community BT_domain -- "refers to" --> BT_domain_type[BT domain type] BT_asset_type -- "refers to" --> BT_parent_asset_type[BT parent asset type up to the root asset type] BT_domain_type -- "refers to" --> BT_parent_domain_type[BT parent domain type up to the root domain...] </pre> </div>

Object	Migrated fields and secondary objects								
Diagram view	<p>Any object referenced in the diagram view or its filter:</p> <ul style="list-style-type: none"> • ID • Name • Asset types <ul style="list-style-type: none"> ◦ ID ◦ Name ◦ Description ◦ Parent asset types, up to the root asset type (for example Business asset) ◦ Display options <ul style="list-style-type: none"> ▪ Color ▪ Symbol (none, Icon or Code) ▪ Code ▪ Icon reference ◦ displayNameEnabled ◦ ratingsEnabled • Characteristic types , for example in an overlay. <ul style="list-style-type: none"> ◦ Attribute types <ul style="list-style-type: none"> ▪ ID ▪ Name ▪ Description ▪ Attribute type kind and its properties <table border="1" data-bbox="563 1368 1417 1899"> <thead> <tr> <th data-bbox="569 1375 738 1447">Kind</th> <th data-bbox="743 1375 1410 1447">Properties</th> </tr> </thead> <tbody> <tr> <td data-bbox="569 1453 738 1520">Date</td> <td data-bbox="743 1453 1410 1520">None</td> </tr> <tr> <td data-bbox="569 1527 738 1780">Multiple selection (Multi value list)</td> <td data-bbox="743 1527 1410 1780"> Allowed values <div style="border-left: 2px solid red; padding-left: 10px; margin-top: 5px;"> Warning The list of allowed values is overwritten in the target environment, so it may remove values. </div> </td> </tr> <tr> <td data-bbox="569 1787 738 1892">Numeric</td> <td data-bbox="743 1787 1410 1892"> <ul style="list-style-type: none"> ▪ Only integers ▪ Metric </td> </tr> </tbody> </table>	Kind	Properties	Date	None	Multiple selection (Multi value list)	Allowed values <div style="border-left: 2px solid red; padding-left: 10px; margin-top: 5px;"> Warning The list of allowed values is overwritten in the target environment, so it may remove values. </div>	Numeric	<ul style="list-style-type: none"> ▪ Only integers ▪ Metric
Kind	Properties								
Date	None								
Multiple selection (Multi value list)	Allowed values <div style="border-left: 2px solid red; padding-left: 10px; margin-top: 5px;"> Warning The list of allowed values is overwritten in the target environment, so it may remove values. </div>								
Numeric	<ul style="list-style-type: none"> ▪ Only integers ▪ Metric 								

Object	Migrated fields and secondary objects										
	<table border="1" data-bbox="563 331 1417 1016"> <thead> <tr> <th data-bbox="563 331 740 409">Kind</th> <th data-bbox="745 331 1417 409">Properties</th> </tr> </thead> <tbody> <tr> <td data-bbox="563 416 740 633">Script</td> <td data-bbox="745 416 1417 633"> Language. <div data-bbox="751 488 1402 616" style="border: 1px solid #ccc; background-color: #f0f0f0; padding: 5px; margin-top: 10px;"> Note This field is only used for validation rule assets. </div> </td> </tr> <tr> <td data-bbox="563 640 740 808">Selection (single value list)</td> <td data-bbox="745 640 1417 808">Allowed values (adding values, AND removals)</td> </tr> <tr> <td data-bbox="563 815 740 882">Text</td> <td data-bbox="745 815 1417 882">Plain text</td> </tr> <tr> <td data-bbox="563 889 740 1016">True/False (boolean)</td> <td data-bbox="745 889 1417 1016">Metric</td> </tr> </tbody> </table> <ul style="list-style-type: none"> ○ Relation types <ul style="list-style-type: none"> ■ ID ■ Description ■ Role ■ Co-role ■ Head asset type <ul style="list-style-type: none"> ■ ID ■ Name ■ Description ■ Parent asset types, up to the root asset type (for example Business asset) ■ Display options <ul style="list-style-type: none"> ■ Color ■ Symbol (none, Icon or Code) ■ Code ■ Icon reference ■ displayNameEnabled ■ ratingsEnabled ■ Tail asset type 	Kind	Properties	Script	Language. <div data-bbox="751 488 1402 616" style="border: 1px solid #ccc; background-color: #f0f0f0; padding: 5px; margin-top: 10px;"> Note This field is only used for validation rule assets. </div>	Selection (single value list)	Allowed values (adding values, AND removals)	Text	Plain text	True/False (boolean)	Metric
Kind	Properties										
Script	Language. <div data-bbox="751 488 1402 616" style="border: 1px solid #ccc; background-color: #f0f0f0; padding: 5px; margin-top: 10px;"> Note This field is only used for validation rule assets. </div>										
Selection (single value list)	Allowed values (adding values, AND removals)										
Text	Plain text										
True/False (boolean)	Metric										

Object	Migrated fields and secondary objects				
	<ul style="list-style-type: none"> ▪ ID ▪ Name ▪ Description ▪ Parent asset types, up to the root asset type (for example Business asset) ▪ Display options <ul style="list-style-type: none"> ▪ Color ▪ Symbol (none, Icon or Code) ▪ Code ▪ Icon reference ▪ displayNameEnabled ▪ ratingsEnabled ○ Complex relation types <ul style="list-style-type: none"> ▪ ID ▪ Name ▪ Description ▪ Display options <ul style="list-style-type: none"> ▪ Color ▪ Symbol (none, Icon or Code) ▪ Code ▪ Icon reference ▪ Attribute types <ul style="list-style-type: none"> ▪ ID ▪ Name ▪ Description ▪ Attribute type kind and its properties <table border="1" data-bbox="603 1527 1417 1682"> <thead> <tr> <th data-bbox="603 1527 778 1608">Kind</th> <th data-bbox="778 1527 1417 1608">Properties</th> </tr> </thead> <tbody> <tr> <td data-bbox="603 1608 778 1682">Date</td> <td data-bbox="778 1608 1417 1682">None</td> </tr> </tbody> </table> 	Kind	Properties	Date	None
Kind	Properties				
Date	None				

Object	Migrated fields and secondary objects														
	<table border="1" data-bbox="603 331 1417 1393"> <thead> <tr> <th data-bbox="608 338 778 409">Kind</th> <th data-bbox="783 338 1412 409">Properties</th> </tr> </thead> <tbody> <tr> <td data-bbox="608 416 778 667">Multiple selection (Multi value list)</td> <td data-bbox="783 416 1412 667"> Allowed values <div style="border-left: 2px solid red; padding-left: 5px; background-color: #f0f0f0;"> Warning The list of allowed values is overwritten in the target environment, so it may remove values. </div> </td> </tr> <tr> <td data-bbox="608 674 778 786">Numeric</td> <td data-bbox="783 674 1412 786"> <ul style="list-style-type: none"> ▪ Only integers ▪ Metric </td> </tr> <tr> <td data-bbox="608 792 778 1010">Script</td> <td data-bbox="783 792 1412 1010"> Language. <div style="border-left: 2px solid gray; padding-left: 5px; background-color: #f0f0f0;"> Note This field is only used for validation rule assets. </div> </td> </tr> <tr> <td data-bbox="608 1016 778 1182">Selection (single value list)</td> <td data-bbox="783 1016 1412 1182">Allowed values (adding values, AND removals)</td> </tr> <tr> <td data-bbox="608 1189 778 1261">Text</td> <td data-bbox="783 1189 1412 1261">Plain text</td> </tr> <tr> <td data-bbox="608 1267 778 1386">True/False (boolean)</td> <td data-bbox="783 1267 1412 1386">Metric</td> </tr> </tbody> </table> <ul style="list-style-type: none"> ▪ Minimum cardinality ▪ Maximum cardinality ▪ Leg types (relation types) <ul style="list-style-type: none"> ▪ Role ▪ Co-role ▪ Asset types that are head or tail of the relation types <ul style="list-style-type: none"> ▪ ID ▪ Name ▪ Description ▪ Parent asset types, up to the root asset type (for example Business asset) 	Kind	Properties	Multiple selection (Multi value list)	Allowed values <div style="border-left: 2px solid red; padding-left: 5px; background-color: #f0f0f0;"> Warning The list of allowed values is overwritten in the target environment, so it may remove values. </div>	Numeric	<ul style="list-style-type: none"> ▪ Only integers ▪ Metric 	Script	Language. <div style="border-left: 2px solid gray; padding-left: 5px; background-color: #f0f0f0;"> Note This field is only used for validation rule assets. </div>	Selection (single value list)	Allowed values (adding values, AND removals)	Text	Plain text	True/False (boolean)	Metric
Kind	Properties														
Multiple selection (Multi value list)	Allowed values <div style="border-left: 2px solid red; padding-left: 5px; background-color: #f0f0f0;"> Warning The list of allowed values is overwritten in the target environment, so it may remove values. </div>														
Numeric	<ul style="list-style-type: none"> ▪ Only integers ▪ Metric 														
Script	Language. <div style="border-left: 2px solid gray; padding-left: 5px; background-color: #f0f0f0;"> Note This field is only used for validation rule assets. </div>														
Selection (single value list)	Allowed values (adding values, AND removals)														
Text	Plain text														
True/False (boolean)	Metric														

Object	Migrated fields and secondary objects
	<ul style="list-style-type: none"> <ul style="list-style-type: none"> ▪ Display options <ul style="list-style-type: none"> ▪ Color ▪ Symbol (none, Icon or Code) ▪ Code ▪ Icon reference ▪ displayNameEnabled ▪ ratingsEnabled ▪ Minimum cardinality ▪ Maximum cardinality • Communities <ul style="list-style-type: none"> ◦ ID ◦ Name ◦ Description ◦ Parent communities, up to the root level <ul style="list-style-type: none"> ▪ ID ▪ Name ▪ Description • Domains <ul style="list-style-type: none"> ◦ ID ◦ Name ◦ Description ◦ Exclude from Autohyperlinking ◦ Domain type <ul style="list-style-type: none"> ▪ ID ▪ Name ▪ Description ▪ Parent domain types up to root <ul style="list-style-type: none"> ▪ ID ▪ Name ▪ Description ◦ Parent communities, up to the root level <ul style="list-style-type: none"> ▪ ID ▪ Name ▪ Description • Roles

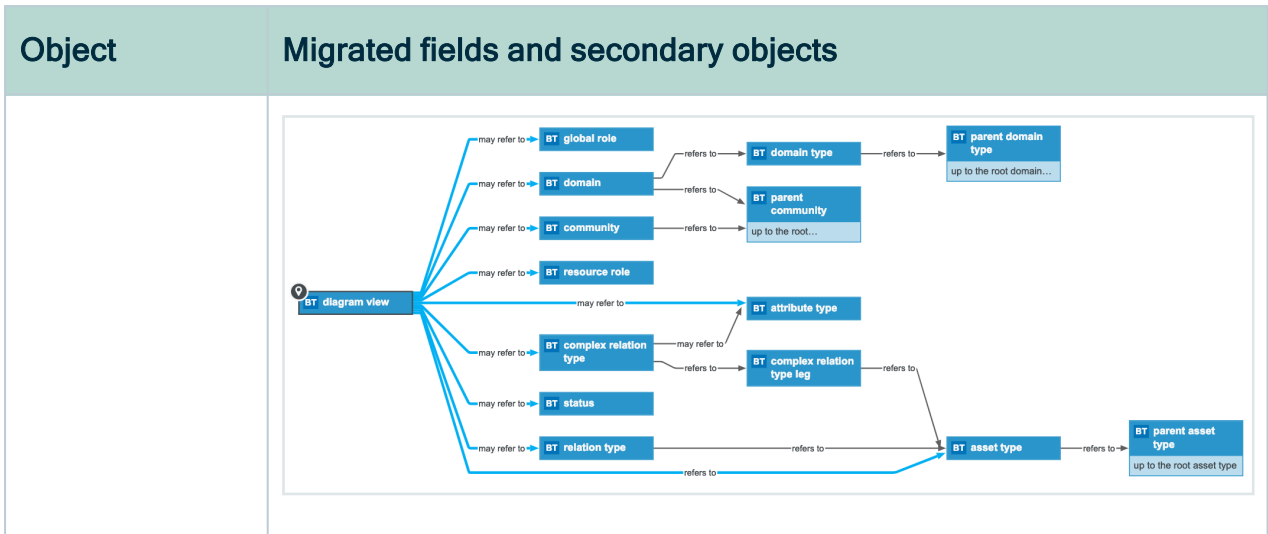

Object	Migrated fields and secondary objects								
Search filter	<p>Any object referenced in the search filter:</p> <ul style="list-style-type: none"> • Asset types <ul style="list-style-type: none"> ◦ ID ◦ Name ◦ Description ◦ Parent asset types, up to the root asset type (for example Business asset) ◦ Display options <ul style="list-style-type: none"> ▪ Color ▪ Symbol (none, Icon or Code) ▪ Code ▪ Icon reference ◦ displayNameEnabled ◦ ratingsEnabled • Characteristic types <ul style="list-style-type: none"> ◦ Attribute types <ul style="list-style-type: none"> ▪ ID ▪ Name ▪ Description ▪ Attribute type kind and its properties <table border="1" data-bbox="563 1279 1417 1809"> <thead> <tr> <th data-bbox="563 1279 738 1355">Kind</th> <th data-bbox="738 1279 1417 1355">Properties</th> </tr> </thead> <tbody> <tr> <td data-bbox="563 1355 738 1431">Date</td> <td data-bbox="738 1355 1417 1431">None</td> </tr> <tr> <td data-bbox="563 1431 738 1691">Multiple selection (Multi value list)</td> <td data-bbox="738 1431 1417 1691"> Allowed values <div style="border-left: 2px solid red; padding-left: 10px; background-color: #f0f0f0;"> Warning The list of allowed values is overwritten in the target environment, so it may remove values. </div> </td> </tr> <tr> <td data-bbox="563 1691 738 1809">Numeric</td> <td data-bbox="738 1691 1417 1809"> <ul style="list-style-type: none"> ▪ Only integers ▪ Metric </td> </tr> </tbody> </table>	Kind	Properties	Date	None	Multiple selection (Multi value list)	Allowed values <div style="border-left: 2px solid red; padding-left: 10px; background-color: #f0f0f0;"> Warning The list of allowed values is overwritten in the target environment, so it may remove values. </div>	Numeric	<ul style="list-style-type: none"> ▪ Only integers ▪ Metric
Kind	Properties								
Date	None								
Multiple selection (Multi value list)	Allowed values <div style="border-left: 2px solid red; padding-left: 10px; background-color: #f0f0f0;"> Warning The list of allowed values is overwritten in the target environment, so it may remove values. </div>								
Numeric	<ul style="list-style-type: none"> ▪ Only integers ▪ Metric 								

Object	Migrated fields and secondary objects										
	<table border="1" data-bbox="563 331 1417 1016"> <thead> <tr> <th data-bbox="563 331 738 409">Kind</th> <th data-bbox="743 331 1417 409">Properties</th> </tr> </thead> <tbody> <tr> <td data-bbox="563 416 738 633">Script</td> <td data-bbox="743 416 1417 633"> Language. <div data-bbox="751 488 1406 618" style="border: 1px solid #ccc; background-color: #f0f0f0; padding: 5px; margin-top: 10px;"> Note This field is only used for validation rule assets. </div> </td> </tr> <tr> <td data-bbox="563 640 738 808">Selection (single value list)</td> <td data-bbox="743 640 1417 808">Allowed values (adding values, AND removals)</td> </tr> <tr> <td data-bbox="563 815 738 882">Text</td> <td data-bbox="743 815 1417 882">Plain text</td> </tr> <tr> <td data-bbox="563 889 738 1016">True/False (boolean)</td> <td data-bbox="743 889 1417 1016">Metric</td> </tr> </tbody> </table> <ul style="list-style-type: none"> ○ Relation types <ul style="list-style-type: none"> ■ ID ■ Description ■ Role ■ Co-role ■ Head asset type <ul style="list-style-type: none"> ■ ID ■ Name ■ Description ■ Parent asset types, up to the root asset type (for example Business asset) ■ Display options <ul style="list-style-type: none"> ■ Color ■ Symbol (none, Icon or Code) ■ Code ■ Icon reference ■ displayNameEnabled ■ ratingsEnabled ■ Tail asset type 	Kind	Properties	Script	Language. <div data-bbox="751 488 1406 618" style="border: 1px solid #ccc; background-color: #f0f0f0; padding: 5px; margin-top: 10px;"> Note This field is only used for validation rule assets. </div>	Selection (single value list)	Allowed values (adding values, AND removals)	Text	Plain text	True/False (boolean)	Metric
Kind	Properties										
Script	Language. <div data-bbox="751 488 1406 618" style="border: 1px solid #ccc; background-color: #f0f0f0; padding: 5px; margin-top: 10px;"> Note This field is only used for validation rule assets. </div>										
Selection (single value list)	Allowed values (adding values, AND removals)										
Text	Plain text										
True/False (boolean)	Metric										

Object	Migrated fields and secondary objects				
	<ul style="list-style-type: none"> ▪ ID ▪ Name ▪ Description ▪ Parent asset types, up to the root asset type (for example Business asset) ▪ Display options <ul style="list-style-type: none"> ▪ Color ▪ Symbol (none, Icon or Code) ▪ Code ▪ Icon reference ▪ displayNameEnabled ▪ ratingsEnabled ○ Complex relation types <ul style="list-style-type: none"> ▪ ID ▪ Name ▪ Description ▪ Display options <ul style="list-style-type: none"> ▪ Color ▪ Symbol (none, Icon or Code) ▪ Code ▪ Icon reference ▪ Attribute types <ul style="list-style-type: none"> ▪ ID ▪ Name ▪ Description ▪ Attribute type kind and its properties <table border="1" data-bbox="603 1527 1417 1682"> <thead> <tr> <th data-bbox="603 1527 778 1608">Kind</th> <th data-bbox="783 1527 1417 1608">Properties</th> </tr> </thead> <tbody> <tr> <td data-bbox="603 1608 778 1682">Date</td> <td data-bbox="783 1608 1417 1682">None</td> </tr> </tbody> </table> 	Kind	Properties	Date	None
Kind	Properties				
Date	None				

Object	Migrated fields and secondary objects														
	<table border="1" data-bbox="603 331 1417 1395"> <thead> <tr> <th data-bbox="608 338 778 409">Kind</th> <th data-bbox="783 338 1412 409">Properties</th> </tr> </thead> <tbody> <tr> <td data-bbox="608 416 778 667">Multiple selection (Multi value list)</td> <td data-bbox="783 416 1412 667"> Allowed values <div style="border-left: 2px solid red; padding-left: 5px; background-color: #f0f0f0;"> Warning The list of allowed values is overwritten in the target environment, so it may remove values. </div> </td> </tr> <tr> <td data-bbox="608 674 778 786">Numeric</td> <td data-bbox="783 674 1412 786"> <ul style="list-style-type: none"> ▪ Only integers ▪ Metric </td> </tr> <tr> <td data-bbox="608 792 778 1010">Script</td> <td data-bbox="783 792 1412 1010"> Language. <div style="border-left: 2px solid gray; padding-left: 5px; background-color: #f0f0f0;"> Note This field is only used for validation rule assets. </div> </td> </tr> <tr> <td data-bbox="608 1016 778 1182">Selection (single value list)</td> <td data-bbox="783 1016 1412 1182">Allowed values (adding values, AND removals)</td> </tr> <tr> <td data-bbox="608 1189 778 1261">Text</td> <td data-bbox="783 1189 1412 1261">Plain text</td> </tr> <tr> <td data-bbox="608 1267 778 1388">True/False (boolean)</td> <td data-bbox="783 1267 1412 1388">Metric</td> </tr> </tbody> </table> <ul style="list-style-type: none"> ▪ Minimum cardinality ▪ Maximum cardinality ▪ Leg types (relation types) <ul style="list-style-type: none"> ▪ Role ▪ Co-role ▪ Asset types that are head or tail of the relation types <ul style="list-style-type: none"> ▪ ID ▪ Name ▪ Description ▪ Parent asset types, up to the root asset type (for example Business asset) 	Kind	Properties	Multiple selection (Multi value list)	Allowed values <div style="border-left: 2px solid red; padding-left: 5px; background-color: #f0f0f0;"> Warning The list of allowed values is overwritten in the target environment, so it may remove values. </div>	Numeric	<ul style="list-style-type: none"> ▪ Only integers ▪ Metric 	Script	Language. <div style="border-left: 2px solid gray; padding-left: 5px; background-color: #f0f0f0;"> Note This field is only used for validation rule assets. </div>	Selection (single value list)	Allowed values (adding values, AND removals)	Text	Plain text	True/False (boolean)	Metric
Kind	Properties														
Multiple selection (Multi value list)	Allowed values <div style="border-left: 2px solid red; padding-left: 5px; background-color: #f0f0f0;"> Warning The list of allowed values is overwritten in the target environment, so it may remove values. </div>														
Numeric	<ul style="list-style-type: none"> ▪ Only integers ▪ Metric 														
Script	Language. <div style="border-left: 2px solid gray; padding-left: 5px; background-color: #f0f0f0;"> Note This field is only used for validation rule assets. </div>														
Selection (single value list)	Allowed values (adding values, AND removals)														
Text	Plain text														
True/False (boolean)	Metric														

Object	Migrated fields and secondary objects
	<ul style="list-style-type: none"> <ul style="list-style-type: none"> ▪ Display options <ul style="list-style-type: none"> ▪ Color ▪ Symbol (none, Icon or Code) ▪ Code ▪ Icon reference ▪ displayNameEnabled ▪ ratingsEnabled ▪ Minimum cardinality ▪ Maximum cardinality • Comments • Communities <ul style="list-style-type: none"> ◦ ID ◦ Name ◦ Description ◦ Parent communities, up to the root level <ul style="list-style-type: none"> ▪ ID ▪ Name ▪ Description • Domains <ul style="list-style-type: none"> ◦ ID ◦ Name ◦ Description ◦ Exclude from Autohyperlinking ◦ Domain type <ul style="list-style-type: none"> ▪ ID ▪ Name ▪ Description ▪ Parent domain types up to root <ul style="list-style-type: none"> ▪ ID ▪ Name ▪ Description ◦ Parent communities, up to the root level <ul style="list-style-type: none"> ▪ ID ▪ Name ▪ Description

Object	Migrated fields and secondary objects
	<ul style="list-style-type: none"> • Roles • Status <ul style="list-style-type: none"> ◦ ID ◦ Name ◦ Description <div style="border: 1px solid #ccc; padding: 10px; margin-top: 10px;"> </div>

Understanding the migration export report

After exporting model objects from a Collibra Data Governance Center environment, a report is created and downloaded alongside the migration file itself. The report is an XLSX file containing a summary of what has been exported.

Structure of the report

The report consists of three worksheets, each containing specific information:

Worksheet name	Contents
Summary	A table that shows the amount of objects of each type that were exported.
Primary Resources	A table in which each row contains a primary object that you exported and the objects that it requires.
Associated Dependencies	A table in which each row contains a secondary object that was exported to support a primary or another secondary object. Its columns is identical to the Primary Resources worksheet.

Columns on the Primary Resources and Associated Dependencies worksheets

The tables on the Primary Resources and the Associated Dependencies worksheets contain information about the exported objects and the objects they require. Each column contains specific information:

Column name	Contents
ResourceType	<p>The type of the object that was exported.</p> <p>For the primary resources, the available values are:</p> <ul style="list-style-type: none"> • Assignment • Role • View:ASSETTABLE • View:DASHBOARD • View:DIAGRAM • View:DOMAINTABLE • Workflow <p>For the associated dependencies, the available values are:</p> <ul style="list-style-type: none"> • AssetType • AttributeType:BooleanAttributeType • AttributeType:DateAttributeType • AttributeType:NumericAttributeType • AttributeType:ScriptAttributeType • AttributeType:SingleValueListAttributeType • AttributeType:StringAttributeType • Community • ComplexRelationType • Domain • DomainType • RelationType • Role • Status <p>ID: The unique identifier of the object that was exported.</p> <p>Name: The name of the object.</p> <p>In most cases, the name is a clickable link that opens Collibra DGC in your browser and shows you the object. The main exceptions are objects of the View:DIAGRAM type and objects of the View:ASSETTABLE type which are asset views containing a relation type on asset pages.</p> <p>For most object types, this column contains only the name of the exported object. However, there are some exceptions:</p> <ul style="list-style-type: none"> • Assignments are exported by asset type. As a consequence, the name is built up accordingly: <asset type> : <assignment>. <div style="background-color: #f0f0f0; padding: 5px; margin: 5px 0;"> <p>Example Business Asset : Global Assignment.</p> </div> <ul style="list-style-type: none"> • View:ASSETTABLE objects which represent an asset view containing a relation

Column name	Contents
	<p>type on asset pages have a name which is built up by several elements: assetType- <asset type ID> relation type-<relation type ID>. In some cases, the name is followed by true catalog.</p> <div data-bbox="469 439 1418 602" style="background-color: #f0f0f0; padding: 5px;"> <p>Example assetType-00000000-0000-0000-0001-000400000001 relationType-00000000-0000-0000-0000-0000000007062 true catalog</p> </div> <ul style="list-style-type: none"> RelationType objects represent a relation type, which doesn't have a specific name. Their name is built up as follows: [<head asset type>] <role> / <co-role> [<tail asset type>]. <div data-bbox="469 748 1418 846" style="background-color: #f0f0f0; padding: 5px;"> <p>Example [Business Asset] represents / represented by [Data Asset]</p> </div> <p>Dependencies: Overview of the secondary objects that are required by the object. They are ordered by type and show the ID and the name of the secondary object.</p>
ID	The unique identifier of the object that was exported.

Column name	Contents
Name	<p>The name of the object.</p> <p>In most cases, the name is a clickable link that opens Collibra DGC in your browser and shows you the object. The main exceptions are objects of the View:DIAGRAM type and objects of the View:ASSETTABLE type which are asset views containing a relation type on asset pages.</p> <p>For most object types, this column contains only the name of the exported object. However, there are some exceptions:</p> <ul style="list-style-type: none"> • Assignments are exported by asset type. As a consequence, the name is built up accordingly: <asset type> : <assignment>. <p style="margin-left: 20px;">Example Business Asset : Global Assignment.</p> <ul style="list-style-type: none"> • View:ASSETTABLE objects which represent an asset view containing a relation type on asset pages have a name which is built up by several elements: assetType-<asset type ID> relation type-<relation type ID>. In some cases, the name is followed by true catalog. <p style="margin-left: 20px;">Example assetType-00000000-0000-0000-0001-000400000001 relationType-00000000-0000-0000-0000-000000007062 true catalog</p> <ul style="list-style-type: none"> • RelationType objects represent a relation type, which doesn't have a specific name. Their name is built up as follows: [<head asset type>] <role> / <co-role> [<tail asset type>]. <p style="margin-left: 20px;">Example [Business Asset] represents / represented by [Data Asset]</p> <p>Dependencies: Overview of the secondary objects that are required by the object. They are ordered by type and show the ID and the name of the secondary object.</p>
Dependencies	<p>Overview of the secondary objects that are required by the object. They are ordered by type and show the ID and the name of the secondary object.</p>

Tracing dependents and precedents

For each object, you can trace whether it is required by another object and which secondary objects it requires. Though this is not visually represented in the XLSX file, you can identify the dependencies by means of the ID.

[Learn more about the export logic of migration.](#)

You can easily see which objects require which objects in the Dependencies column. A quick way to trace dependents and precedents is to copy the ID of a dependent object, and search for it in the entire workbook.

Tip

- All objects in the Associated Dependencies worksheet can be traced back to one or more primary objects.
- You can let MS Excel find all matches in the entire workbook, which will give you a quick overview of all occurrences of the ID on all worksheets of the workbook.

Example 1: Precedents

You exported a number of workflows. You notice in the report that the Acronym asset type was also exported. You want to know why that asset type was exported. You search for all occurrences of the ID of the asset type in the entire workbook. You find concurrences on the Associated Dependencies and/or Primary Resources worksheets, where you can see which objects require the Acronym asset type.

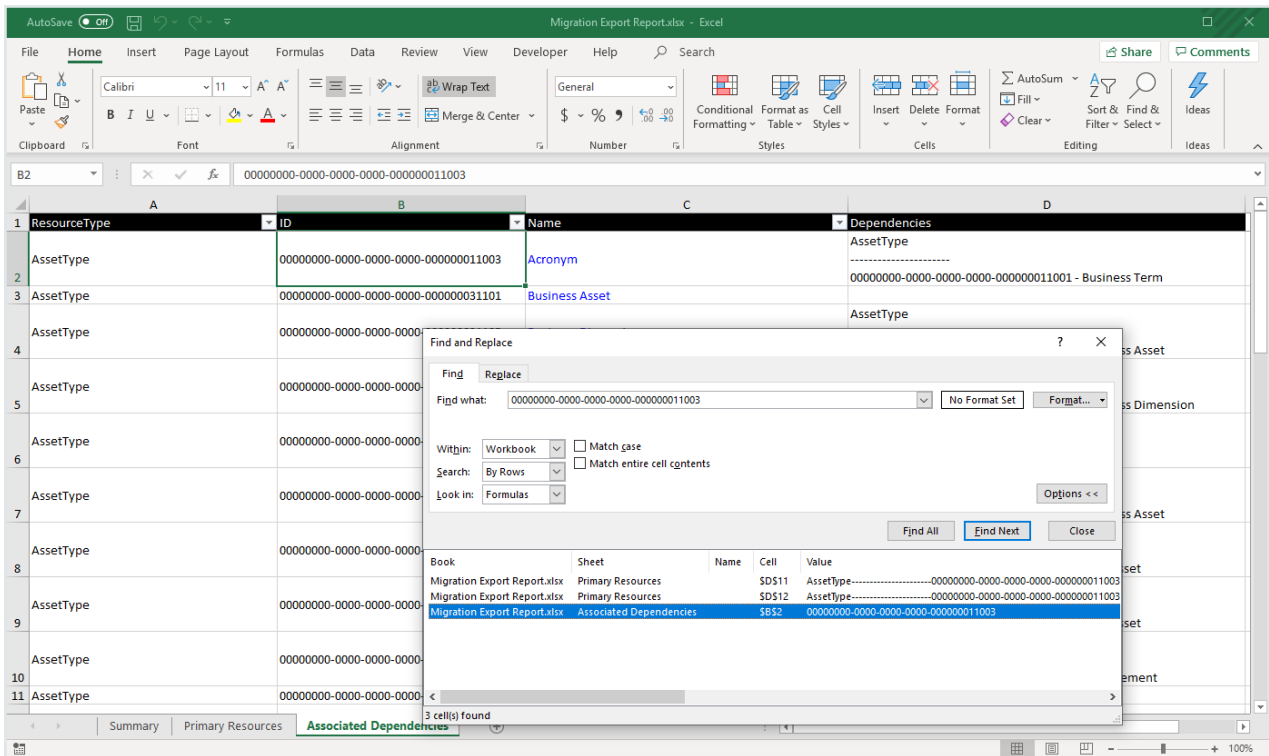

Example 2: Dependents

You exported the Issue Creation Workflow. In the Dependencies column, you see that it requires the [Issue] impacts / impacted by [Asset] relation type. You want to see whether that relation type in turn also requires other objects to be exported. You search for all occurrences of the ID of the relation type in the entire workbook. You find the row on the Associated Dependencies worksheet, where you can check its dependencies.

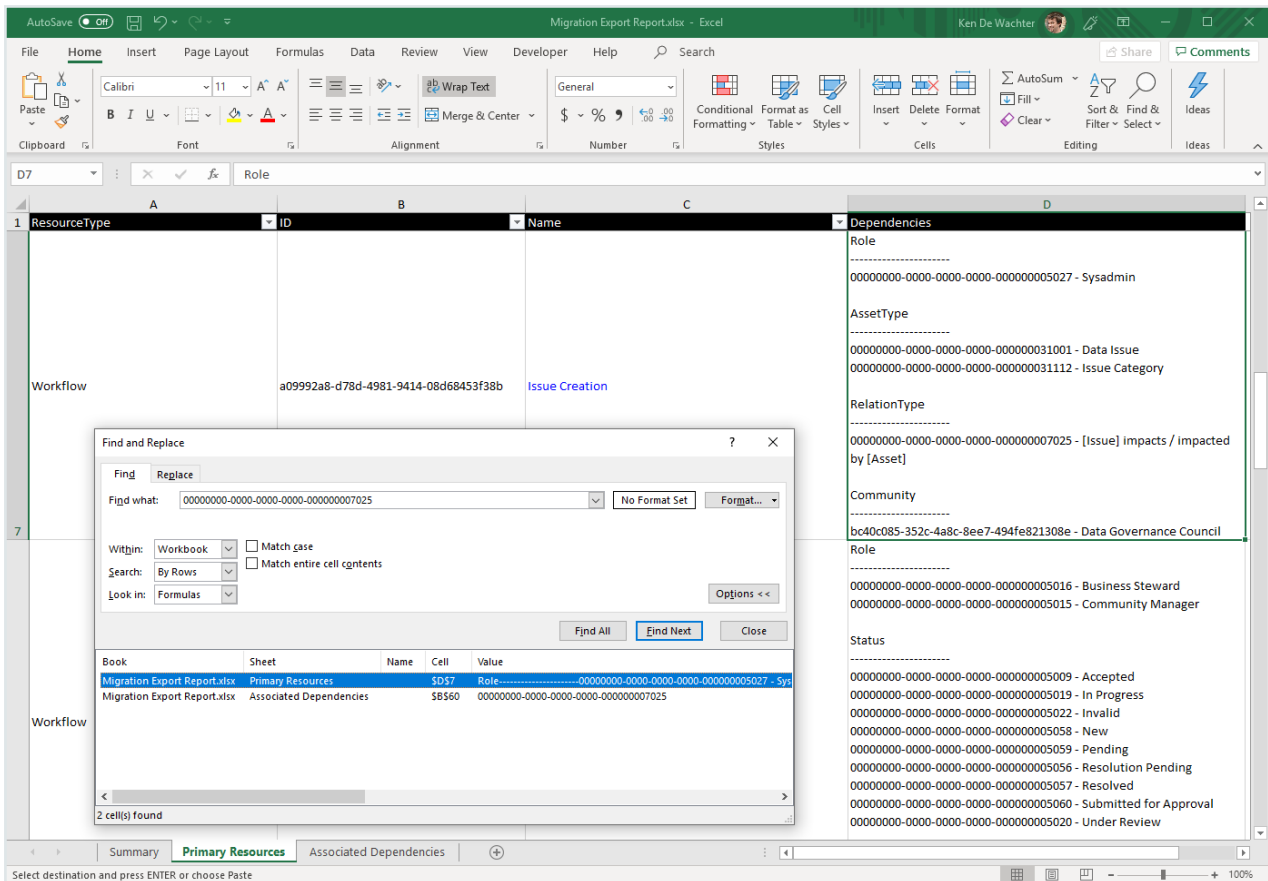

Import model objects

Using the [Migration](#) feature, you can import an archive file containing model objects of a Collibra Data Governance Center environment.

Note Exporting and importing CMA files is restricted by the file upload settings, which determine the maximum file size, allowed file extensions and maximum amount of uploads and downloads per day. Contact [Collibra support](#) if you want to change the file upload settings.



Warning

- Importing model objects cannot be undone. Make sure that there is a recent backup available before doing this.
- The versions of the source and target environment have to be the same. Migrating between different versions may lead to unexpected behavior.

Prerequisites

- You have a [global role](#) that has the System administration [global permission](#).
- An archive file that was exported from an environment that has the same Collibra DGC version.
- A backup of the environment.

Steps

1. In the main menu, click , then  **Settings**.
 - » The [Collibra DGC settings page](#) opens.
2. Click **Migration**.
 - » The migration page appears on the **Export** tab page.
3. In the tab pane, click **Migration** → **Import**.
 - » The **Migration Import** page appears.
4. Upload an archive file in one of the following ways:
 - Drag and drop the file in the upload area.
 - Click **Upload a file**, browse to the location of the file and click **Open**.
 - » An overview of the model objects that will be added, edited, or removed appears.

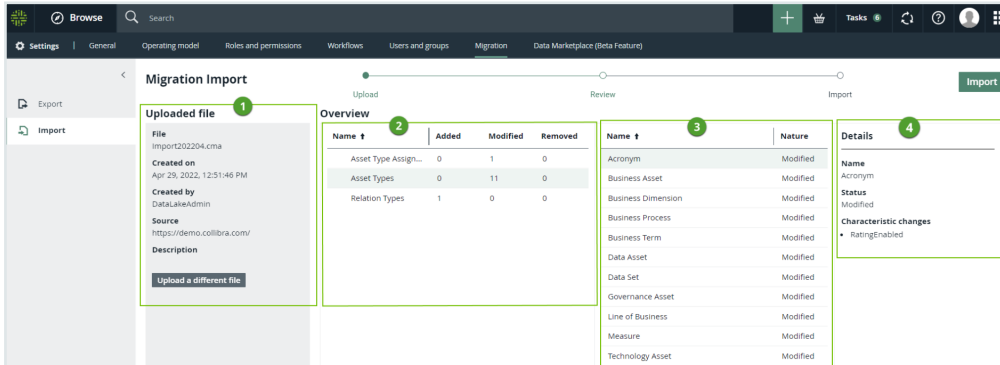

Number	Description
1	Details about the uploaded archive file.
2	A table that shows, for each type, the number of model objects that will be added, edited, or removed.
3	When you select a specific type, the list of model objects appears. For each model object, you can see what will happen.

Number	Description
4	When you select a specific model object, details about change appear.

5. Review the import simulation by verifying the model objects that will be added, edited, and removed.
6. Click **Import**.
 - » The **Confirm import** dialog appears.
7. Select **I have an up-to-date backup containing the data and history of this Collibra platform**.
8. Click **Import**.
 - » The archive file is imported, meaning that model objects are created, edited, or removed as necessary. This can take some time.
 - » Once the import is completed, you can download an import report.

Migration import logic

The import logic determines how migrated objects are matched to objects in the target environment, and what happens if a match is found.

Import matching

During import, Collibra Data Governance Center tries to match each migrated object with an object in the target. In most cases, matching is done first based on the ID of the object. If the target environment does not have an object matching the ID, the matching algorithm will try to use a logical key. This logical key may be different depending of the type of object.

1. By ID
2. By logical key

Tip

In most cases, the logical key is the Name field, within the same type of object. For others, it is usually a combination of properties. For example:

- For relation types, the logical key is the combination of the source (head) asset type, the role, the co-role and the target (tail) asset type.
- For assignment, the logical key is the combination of the asset type ID and scope ID.

Outcome of importing an object

Depending on the similarity of the objects in the archive and the target environment, importing an archive may create or edit objects.

Tip Migration will never delete objects, but it may reduce assignments, rename assets and so on.

The table below contains the general import logic.

Outcome	When	Description
A matched object is not edited.	<ol style="list-style-type: none"> 1. A match is found based on the matching logic. 2. The matched object has the same properties as the migrated object. 	If the migrated object and the object in the target environment have the same properties, nothing happens.

Outcome	When	Description
A matched object is edited.	<ol style="list-style-type: none"> 1. A match is found based on the matching logic. 2. The matched object has different properties than the migrated object. 	<p>The matched object will be edited with the properties from the migrated object. Migration will never delete objects, but it may reduce assignments, rename assets and so on.</p> <div style="border: 1px solid #ccc; background-color: #f9f9f9; padding: 10px; margin-top: 10px;"> <p>Example</p> <ul style="list-style-type: none"> • If you migrate an assignment that includes fewer characteristic types than in the target, Collibra DGC removes those characteristic types from the assignments, but does not delete the actual characteristic types. • If you migrate a view with a filter on a community that has a different name in the target, Collibra DGC renames the community in the target. </div>

Outcome	When	Description
An unmatched object is updated.	<ol style="list-style-type: none"> <li data-bbox="389 338 678 562">1. A match is found based on the ID of the objects, but they have different names. <li data-bbox="389 573 678 846">2. In the target environment, another object has the same name as the migrated object. 	<ol style="list-style-type: none"> <li data-bbox="697 338 1410 472">1. The name of the existing object with the same name will be changed to <code><original name>-Migration-YYYYMMDD hh:mm:ss</code>. <li data-bbox="697 483 1410 618">2. The matched object will be edited with the properties from the migrated object, including the name. <div data-bbox="708 640 1410 1603" style="border-left: 2px solid #0070C0; padding-left: 10px; margin-top: 10px;"> <p data-bbox="756 674 884 707">Example</p> <p data-bbox="756 714 1007 748">Before the import:</p> <ul data-bbox="764 781 1366 1167" style="list-style-type: none"> <li data-bbox="764 781 1366 893">• The target environment contains an asset type with the following information: Name: <code>Crawler</code>, ID: <code>0000</code>. <li data-bbox="764 898 1366 1050">• The target environment contains a second asset type with the following information: Name: <code>AWS Crawler</code>, ID: <code>1111</code>. <li data-bbox="764 1055 1366 1167">• The archive contains an asset type with the following information: Name: <code>AWS Crawler</code>, ID: <code>0000</code>. <p data-bbox="756 1200 979 1234">After the import:</p> <ul data-bbox="764 1267 1366 1570" style="list-style-type: none"> <li data-bbox="764 1267 1366 1379">• The target environment contains an asset type with the following information: Name: <code>AWS Crawler</code>, ID: <code>0000</code>. <li data-bbox="764 1384 1366 1570">• The target environment contains a second asset type with the following information: Name: <code>AWS Crawler-Migration-20210101 13:15:12</code>, ID: <code>1111</code>. </div>
A new object is created.	If no match is found.	A new object is created with all properties from the migrated object, including the ID.

Import logic by object

Depending on the migrated object, different fields and secondary objects are exported along with it. This also affects the matching logic when these objects are imported in the target environment. The table below gives further information about how primary and secondary objects are imported.

Object	Import logic																
Asset	<p>Matching logic based on:</p> <ol style="list-style-type: none"> 1. ID 2. Full name and parent domain <p>The following table contains the possible cases and results.</p> <table border="1"> <thead> <tr> <th>Case</th> <th>Matched asset 1</th> <th>Matched asset 2</th> <th>Result</th> </tr> </thead> <tbody> <tr> <td>1</td> <td>ID</td> <td>n/a</td> <td>Matched asset 1 is updated.</td> </tr> <tr> <td>2</td> <td>Full name and parent domain</td> <td>n/a</td> <td>Matched asset 1 is updated.</td> </tr> <tr> <td>3</td> <td>None</td> <td>n/a</td> <td>A new asset is created.</td> </tr> </tbody> </table> <p>Note Assets in system-owned domains (for example Issues) cannot be migrated.</p>	Case	Matched asset 1	Matched asset 2	Result	1	ID	n/a	Matched asset 1 is updated.	2	Full name and parent domain	n/a	Matched asset 1 is updated.	3	None	n/a	A new asset is created.
Case	Matched asset 1	Matched asset 2	Result														
1	ID	n/a	Matched asset 1 is updated.														
2	Full name and parent domain	n/a	Matched asset 1 is updated.														
3	None	n/a	A new asset is created.														

Object	Import logic																								
Asset type	<p data-bbox="443 338 794 376">Matching logic based on:</p> <ol data-bbox="443 412 667 539" style="list-style-type: none"> <li data-bbox="443 412 667 450">1. ID and name <li data-bbox="443 456 571 495">2. Name <li data-bbox="443 501 517 539">3. ID <p data-bbox="443 575 1273 613">The following table contains the possible cases and results.</p> <table border="1" data-bbox="443 642 1414 1574"> <thead> <tr> <th data-bbox="451 651 579 824">Case</th> <th data-bbox="587 651 770 824">Matched asset type 1</th> <th data-bbox="778 651 962 824">Matched asset type 2</th> <th data-bbox="970 651 1406 824">Result</th> </tr> </thead> <tbody> <tr> <td data-bbox="451 835 579 958">1</td> <td data-bbox="587 835 770 958">ID and name</td> <td data-bbox="778 835 962 958">n/a</td> <td data-bbox="970 835 1406 958">Matched asset type 1 is updated.</td> </tr> <tr> <td data-bbox="451 969 579 1216">2</td> <td data-bbox="587 969 770 1216">ID</td> <td data-bbox="778 969 962 1216">Name</td> <td data-bbox="970 969 1406 1216">Matched asset type 1 is updated. Matched asset type 2 is renamed.</td> </tr> <tr> <td data-bbox="451 1227 579 1350">3</td> <td data-bbox="587 1227 770 1350">Name</td> <td data-bbox="778 1227 962 1350">n/a</td> <td data-bbox="970 1227 1406 1350">Matched asset type 1 is updated.</td> </tr> <tr> <td data-bbox="451 1361 579 1485">4</td> <td data-bbox="587 1361 770 1485">ID</td> <td data-bbox="778 1361 962 1485">n/a</td> <td data-bbox="970 1361 1406 1485">Matched asset type 1 is updated.</td> </tr> <tr> <td data-bbox="451 1496 579 1574">5</td> <td data-bbox="587 1496 770 1574">None</td> <td data-bbox="778 1496 962 1574">n/a</td> <td data-bbox="970 1496 1406 1574">A new asset type is created.</td> </tr> </tbody> </table> <div data-bbox="443 1603 1414 1899" style="background-color: #f0f0f0; padding: 10px;"> <p data-bbox="491 1637 563 1675">Note</p> <ul data-bbox="499 1675 1342 1865" style="list-style-type: none"> <li data-bbox="499 1675 1342 1832">• If for an asset type, ratings are disabled in the archive file, but the matched asset type in the target environment has ratings enabled, the import will fail. This is because migration cannot delete the ratings of assets of that type. <li data-bbox="499 1832 1262 1865">• Asset types are imported using the depth-first order. </div>	Case	Matched asset type 1	Matched asset type 2	Result	1	ID and name	n/a	Matched asset type 1 is updated.	2	ID	Name	Matched asset type 1 is updated. Matched asset type 2 is renamed.	3	Name	n/a	Matched asset type 1 is updated.	4	ID	n/a	Matched asset type 1 is updated.	5	None	n/a	A new asset type is created.
Case	Matched asset type 1	Matched asset type 2	Result																						
1	ID and name	n/a	Matched asset type 1 is updated.																						
2	ID	Name	Matched asset type 1 is updated. Matched asset type 2 is renamed.																						
3	Name	n/a	Matched asset type 1 is updated.																						
4	ID	n/a	Matched asset type 1 is updated.																						
5	None	n/a	A new asset type is created.																						

Object	Import logic																
Assignment	<p data-bbox="440 338 794 376">Matching logic based on:</p> <ol data-bbox="440 409 786 495" style="list-style-type: none"> <li data-bbox="440 409 512 443">1. ID <li data-bbox="440 454 786 495">2. Asset type and scope <p data-bbox="440 528 1273 566">The following table contains the possible cases and results.</p> <table border="1" data-bbox="440 595 1414 1137"> <thead> <tr> <th data-bbox="440 595 576 730">Case</th> <th data-bbox="580 595 807 730">Matched assignment 1</th> <th data-bbox="812 595 1038 730">Matched assignment 2</th> <th data-bbox="1043 595 1414 730">Result</th> </tr> </thead> <tbody> <tr> <td data-bbox="440 736 576 864">1</td> <td data-bbox="580 736 807 864">ID</td> <td data-bbox="812 736 1038 864">n/a</td> <td data-bbox="1043 736 1414 864">Matched assignment 1 is updated.</td> </tr> <tr> <td data-bbox="440 871 576 999">2</td> <td data-bbox="580 871 807 999">Asset type and scope</td> <td data-bbox="812 871 1038 999">n/a</td> <td data-bbox="1043 871 1414 999">Matched assignment 1 is updated.</td> </tr> <tr> <td data-bbox="440 1005 576 1133">3</td> <td data-bbox="580 1005 807 1133">None</td> <td data-bbox="812 1005 1038 1133">n/a</td> <td data-bbox="1043 1005 1414 1133">A new assignment is created.</td> </tr> </tbody> </table> <div data-bbox="440 1167 1414 1368" style="background-color: #f0f0f0; padding: 10px;"> <p data-bbox="491 1200 1217 1238">Note Assignments are imported in a specific order:</p> <ol data-bbox="491 1261 831 1339" style="list-style-type: none"> <li data-bbox="491 1261 815 1299">1. Global assignments <li data-bbox="491 1299 831 1339">2. Scoped assignments </div>	Case	Matched assignment 1	Matched assignment 2	Result	1	ID	n/a	Matched assignment 1 is updated.	2	Asset type and scope	n/a	Matched assignment 1 is updated.	3	None	n/a	A new assignment is created.
Case	Matched assignment 1	Matched assignment 2	Result														
1	ID	n/a	Matched assignment 1 is updated.														
2	Asset type and scope	n/a	Matched assignment 1 is updated.														
3	None	n/a	A new assignment is created.														

Object	Import logic																
Attribute	<p>Matching logic based on:</p> <ol style="list-style-type: none"> 1. ID 2. Combination of parent asset, attribute type and value <p>The following table contains the possible cases and results.</p> <table border="1" data-bbox="443 595 1412 1184"> <thead> <tr> <th data-bbox="443 595 579 730">Case</th> <th data-bbox="579 595 818 730">Matched object 1</th> <th data-bbox="818 595 1010 730">Matched object 2</th> <th data-bbox="1010 595 1412 730">Result</th> </tr> </thead> <tbody> <tr> <td data-bbox="443 730 579 864">1</td> <td data-bbox="579 730 818 864">ID</td> <td data-bbox="818 730 1010 864">n/a</td> <td data-bbox="1010 730 1412 864">Matched object 1 is updated.</td> </tr> <tr> <td data-bbox="443 864 579 1099">2</td> <td data-bbox="579 864 818 1099">Combination of parent asset, attribute type and value</td> <td data-bbox="818 864 1010 1099">n/a</td> <td data-bbox="1010 864 1412 1099">Matched object 1 is updated.</td> </tr> <tr> <td data-bbox="443 1099 579 1184">3</td> <td data-bbox="579 1099 818 1184">None</td> <td data-bbox="818 1099 1010 1184">n/a</td> <td data-bbox="1010 1099 1412 1184">A new object is created.</td> </tr> </tbody> </table> <div data-bbox="443 1211 1412 1464" style="background-color: #f0f0f0; padding: 10px;"> <p>Note</p> <ul style="list-style-type: none"> • Attributes in system-owned domains (for example Issues) cannot be migrated. • The only fields that you can migrate are validation scripts of validation rule assets and description fields of any resource. </div>	Case	Matched object 1	Matched object 2	Result	1	ID	n/a	Matched object 1 is updated.	2	Combination of parent asset, attribute type and value	n/a	Matched object 1 is updated.	3	None	n/a	A new object is created.
Case	Matched object 1	Matched object 2	Result														
1	ID	n/a	Matched object 1 is updated.														
2	Combination of parent asset, attribute type and value	n/a	Matched object 1 is updated.														
3	None	n/a	A new object is created.														

Object	Import logic								
Attribute type	<p data-bbox="440 338 794 376">Matching logic based on:</p> <ol data-bbox="440 412 738 539" style="list-style-type: none"> <li data-bbox="440 412 738 450">1. ID, name and kind <li data-bbox="440 456 695 495">2. Name and kind <li data-bbox="440 501 643 539">3. ID and kind <p data-bbox="440 575 1273 613">The following table contains the possible cases and results.</p> <table border="1" data-bbox="440 642 1417 1032"> <thead> <tr> <th data-bbox="440 642 579 824">Case</th> <th data-bbox="584 642 770 824">Matched attribute type 1</th> <th data-bbox="775 642 962 824">Matched attribute type 2</th> <th data-bbox="967 642 1417 824">Result</th> </tr> </thead> <tbody> <tr> <td data-bbox="440 831 579 1032">1</td> <td data-bbox="584 831 770 1032">ID, name and kind</td> <td data-bbox="775 831 962 1032">n/a</td> <td data-bbox="967 831 1417 1032">Matched attribute type 1 is updated.</td> </tr> </tbody> </table>	Case	Matched attribute type 1	Matched attribute type 2	Result	1	ID, name and kind	n/a	Matched attribute type 1 is updated.
Case	Matched attribute type 1	Matched attribute type 2	Result						
1	ID, name and kind	n/a	Matched attribute type 1 is updated.						

Object	Import logic			
	Case	Matched attribute type 1	Matched attribute type 2	Result
	2	ID and name	n/a	<p>Matched attribute type 1 is renamed.</p> <p>A new attribute type is created.</p> <div data-bbox="979 779 1401 1496" style="border: 1px solid #ccc; padding: 10px; background-color: #f9f9f9;"> <p>Note Because you cannot edit the attribute type kind through Collibra DGC's UI, this can only be done if:</p> <ol style="list-style-type: none"> 1. An attribute type is deleted. 2. Using the Java/REST API, a new attribute type is created with the same name and ID as the deleted attribute type, but with a different kind. </div>
	3	Name	n/a	<p>Matched attribute type 1 is renamed.</p> <p>A new attribute type is created.</p>
	4	Name and kind	n/a	<p>The ID of matched attribute type 1 is updated.</p>

Object	Import logic			
	Case	Matched attribute type 1	Matched attribute type 2	Result
5	ID and kind	n/a	Matched attribute type 1 is renamed and updated.	
6	ID	n/a	<p>A new attribute type is created with a new ID.</p> <div data-bbox="978 792 1410 1514" style="border: 1px solid #ccc; padding: 10px; background-color: #f9f9f9;"> <p>Note Because you cannot edit the attribute type kind through Collibra DGC's UI, this can only be done if:</p> <ol style="list-style-type: none"> 1. An attribute type is deleted. 2. Using the Java/REST API, a new attribute type is created with the same name and ID as the deleted attribute type, but with a different kind. </div>	
7	ID and kind	Name and kind	Matched attribute type 2 is updated.	
8	ID and kind	Name	<p>Matched attribute type 1 is renamed and updated.</p> <p>Matched attribute type 2 is renamed.</p>	

Object	Import logic			
	Case	Matched attribute type 1	Matched attribute type 2	Result
	9	ID	Name and kind	Matched attribute type 2 is updated.
	10	ID	Name	Matched attribute type 2 is renamed. A new attribute type is created with a new ID.
	11	None	n/a	A new attribute type is created.
	<p>Note If you import an attribute type of the kind Selection or Multiple Selection via the Solution install, allowed values from the CMA file are added to the list of allowed values in the target environment.</p>			
	<p>Tip If you know that fundamental changes were made to attribute types, you can avoid import problems by deleting attribute types in the target migration before importing the archive.</p>			

Object	Import logic																								
Community	<p data-bbox="438 338 794 376">Matching logic based on:</p> <ol data-bbox="438 412 663 539" style="list-style-type: none"> <li data-bbox="438 412 663 450">1. ID and name <li data-bbox="438 456 568 495">2. Name <li data-bbox="438 501 512 539">3. ID <p data-bbox="438 575 1273 613">The following table contains the possible cases and results.</p> <table border="1" data-bbox="443 642 1417 1574"> <thead> <tr> <th data-bbox="448 651 576 779">Case</th> <th data-bbox="580 651 794 779">Matched community 1</th> <th data-bbox="799 651 1013 779">Matched community 2</th> <th data-bbox="1018 651 1412 779">Result</th> </tr> </thead> <tbody> <tr> <td data-bbox="448 786 576 913">1</td> <td data-bbox="580 786 794 913">ID and name</td> <td data-bbox="799 786 1013 913">n/a</td> <td data-bbox="1018 786 1412 913">Matched community 1 is updated.</td> </tr> <tr> <td data-bbox="448 920 576 1167">2</td> <td data-bbox="580 920 794 1167">ID</td> <td data-bbox="799 920 1013 1167">Name</td> <td data-bbox="1018 920 1412 1167">Matched community 1 is updated. Matched community 2 is renamed.</td> </tr> <tr> <td data-bbox="448 1173 576 1301">3</td> <td data-bbox="580 1173 794 1301">Name</td> <td data-bbox="799 1173 1013 1301">n/a</td> <td data-bbox="1018 1173 1412 1301">Matched community 1 is updated.</td> </tr> <tr> <td data-bbox="448 1308 576 1435">4</td> <td data-bbox="580 1308 794 1435">ID</td> <td data-bbox="799 1308 1013 1435">n/a</td> <td data-bbox="1018 1308 1412 1435">Matched community 1 is updated.</td> </tr> <tr> <td data-bbox="448 1442 576 1570">5</td> <td data-bbox="580 1442 794 1570">None</td> <td data-bbox="799 1442 1013 1570">n/a</td> <td data-bbox="1018 1442 1412 1570">A new community is created.</td> </tr> </tbody> </table> <p data-bbox="491 1632 1337 1671">Note Communities are imported using the depth-first order.</p>	Case	Matched community 1	Matched community 2	Result	1	ID and name	n/a	Matched community 1 is updated.	2	ID	Name	Matched community 1 is updated. Matched community 2 is renamed.	3	Name	n/a	Matched community 1 is updated.	4	ID	n/a	Matched community 1 is updated.	5	None	n/a	A new community is created.
Case	Matched community 1	Matched community 2	Result																						
1	ID and name	n/a	Matched community 1 is updated.																						
2	ID	Name	Matched community 1 is updated. Matched community 2 is renamed.																						
3	Name	n/a	Matched community 1 is updated.																						
4	ID	n/a	Matched community 1 is updated.																						
5	None	n/a	A new community is created.																						

Object	Import logic																								
Complex relation type	<p data-bbox="440 338 794 376">Matching logic based on:</p> <ol data-bbox="440 412 663 539" style="list-style-type: none"> <li data-bbox="440 412 663 450">1. ID and name <li data-bbox="440 456 568 495">2. Name <li data-bbox="440 501 512 539">3. ID <p data-bbox="440 575 1273 613">The following table contains the possible cases and results.</p> <table border="1" data-bbox="440 642 1417 1668"> <thead> <tr> <th data-bbox="443 651 576 869">Case</th> <th data-bbox="580 651 767 869">Matched complex relation type 1</th> <th data-bbox="772 651 959 869">Matched complex relation type 2</th> <th data-bbox="963 651 1414 869">Result</th> </tr> </thead> <tbody> <tr> <td data-bbox="443 875 576 1003">1</td> <td data-bbox="580 875 767 1003">ID and name</td> <td data-bbox="772 875 959 1003">n/a</td> <td data-bbox="963 875 1414 1003">Matched complex relation type 1 is updated.</td> </tr> <tr> <td data-bbox="443 1010 576 1261">2</td> <td data-bbox="580 1010 767 1261">ID</td> <td data-bbox="772 1010 959 1261">Name</td> <td data-bbox="963 1010 1414 1261">Matched complex relation type 1 is updated. Matched complex relation type 2 is renamed.</td> </tr> <tr> <td data-bbox="443 1267 576 1395">3</td> <td data-bbox="580 1267 767 1395">ID</td> <td data-bbox="772 1267 959 1395">n/a</td> <td data-bbox="963 1267 1414 1395">Matched complex relation type 1 is updated.</td> </tr> <tr> <td data-bbox="443 1402 576 1529">4</td> <td data-bbox="580 1402 767 1529">Name</td> <td data-bbox="772 1402 959 1529">n/a</td> <td data-bbox="963 1402 1414 1529">Matched complex relation type 1 is updated.</td> </tr> <tr> <td data-bbox="443 1536 576 1664">5</td> <td data-bbox="580 1536 767 1664">None</td> <td data-bbox="772 1536 959 1664">n/a</td> <td data-bbox="963 1536 1414 1664">A new complex relation type is created.</td> </tr> </tbody> </table>	Case	Matched complex relation type 1	Matched complex relation type 2	Result	1	ID and name	n/a	Matched complex relation type 1 is updated.	2	ID	Name	Matched complex relation type 1 is updated. Matched complex relation type 2 is renamed.	3	ID	n/a	Matched complex relation type 1 is updated.	4	Name	n/a	Matched complex relation type 1 is updated.	5	None	n/a	A new complex relation type is created.
Case	Matched complex relation type 1	Matched complex relation type 2	Result																						
1	ID and name	n/a	Matched complex relation type 1 is updated.																						
2	ID	Name	Matched complex relation type 1 is updated. Matched complex relation type 2 is renamed.																						
3	ID	n/a	Matched complex relation type 1 is updated.																						
4	Name	n/a	Matched complex relation type 1 is updated.																						
5	None	n/a	A new complex relation type is created.																						

Object	Import logic
	<p data-bbox="491 367 560 398">Note</p> <ul data-bbox="499 405 1374 831" style="list-style-type: none"><li data-bbox="499 405 1374 595">• When a complex relation leg type has the same role, co-role and target asset type than an existing one in the matched complex relation type, the existing one will be updated, even when the ID is different. Adding a second relation type with the same properties would result in an error.<li data-bbox="499 602 1374 757">• Updating the assignment of a complex relation type which impacts leg types and attribute types can remove a leg type if it is no longer included in the migration archive. If the leg type has instance data, the import will fail.<li data-bbox="499 763 1374 831">• Migration does not update leg types when source, target, role, co-role are identical.

Object	Import logic																								
Data quality rule	<p data-bbox="440 338 794 376">Matching logic based on:</p> <ol data-bbox="440 412 663 539" style="list-style-type: none"> <li data-bbox="440 412 663 450">1. ID and name <li data-bbox="440 456 568 495">2. Name <li data-bbox="440 501 512 539">3. ID <p data-bbox="440 575 1273 613">The following table contains the possible cases and results.</p> <table border="1" data-bbox="440 642 1414 1668"> <thead> <tr> <th data-bbox="446 651 576 869">Case</th> <th data-bbox="582 651 770 869">Matched data quality rule 1</th> <th data-bbox="777 651 965 869">Matched data quality rule 2</th> <th data-bbox="971 651 1407 869">Result</th> </tr> </thead> <tbody> <tr> <td data-bbox="446 878 576 1005">1</td> <td data-bbox="582 878 770 1005">ID and name</td> <td data-bbox="777 878 965 1005">n/a</td> <td data-bbox="971 878 1407 1005">Matched data quality rule 1 is updated.</td> </tr> <tr> <td data-bbox="446 1014 576 1263">2</td> <td data-bbox="582 1014 770 1263">ID</td> <td data-bbox="777 1014 965 1263">Name</td> <td data-bbox="971 1014 1407 1263">Matched data quality rule 1 is updated. Matched data quality rule 2 is renamed.</td> </tr> <tr> <td data-bbox="446 1272 576 1400">3</td> <td data-bbox="582 1272 770 1400">Name</td> <td data-bbox="777 1272 965 1400">n/a</td> <td data-bbox="971 1272 1407 1400">Matched data quality rule 1 is updated.</td> </tr> <tr> <td data-bbox="446 1408 576 1536">4</td> <td data-bbox="582 1408 770 1536">ID</td> <td data-bbox="777 1408 965 1536">n/a</td> <td data-bbox="971 1408 1407 1536">Matched data quality rule 1 is updated.</td> </tr> <tr> <td data-bbox="446 1545 576 1673">5</td> <td data-bbox="582 1545 770 1673">None</td> <td data-bbox="777 1545 965 1673">n/a</td> <td data-bbox="971 1545 1407 1673">A new data quality rule is created.</td> </tr> </tbody> </table>	Case	Matched data quality rule 1	Matched data quality rule 2	Result	1	ID and name	n/a	Matched data quality rule 1 is updated.	2	ID	Name	Matched data quality rule 1 is updated. Matched data quality rule 2 is renamed.	3	Name	n/a	Matched data quality rule 1 is updated.	4	ID	n/a	Matched data quality rule 1 is updated.	5	None	n/a	A new data quality rule is created.
Case	Matched data quality rule 1	Matched data quality rule 2	Result																						
1	ID and name	n/a	Matched data quality rule 1 is updated.																						
2	ID	Name	Matched data quality rule 1 is updated. Matched data quality rule 2 is renamed.																						
3	Name	n/a	Matched data quality rule 1 is updated.																						
4	ID	n/a	Matched data quality rule 1 is updated.																						
5	None	n/a	A new data quality rule is created.																						

Object	Import logic																								
Domain	<p>Matching logic based on:</p> <ol style="list-style-type: none"> 1. ID and name 2. Name and parent community 3. ID <p>The following table contains the possible cases and results.</p> <table border="1" data-bbox="443 645 1417 1574"> <thead> <tr> <th data-bbox="443 645 579 779">Case</th> <th data-bbox="584 645 794 779">Matched domain 1</th> <th data-bbox="794 645 1005 779">Matched domain 2</th> <th data-bbox="1010 645 1417 779">Result</th> </tr> </thead> <tbody> <tr> <td data-bbox="443 779 579 913">1</td> <td data-bbox="584 779 794 913">ID and name</td> <td data-bbox="794 779 1005 913">n/a</td> <td data-bbox="1010 779 1417 913">Matched domain 1 is updated.</td> </tr> <tr> <td data-bbox="443 913 579 1171">2</td> <td data-bbox="584 913 794 1171">ID</td> <td data-bbox="794 913 1005 1171">Name and parent community</td> <td data-bbox="1010 913 1417 1171">Matched domain 1 is updated. Matched domain 2 is renamed.</td> </tr> <tr> <td data-bbox="443 1171 579 1350">3</td> <td data-bbox="584 1171 794 1350">Name and parent community</td> <td data-bbox="794 1171 1005 1350">n/a</td> <td data-bbox="1010 1171 1417 1350">Matched domain 1 is updated.</td> </tr> <tr> <td data-bbox="443 1350 579 1485">4</td> <td data-bbox="584 1350 794 1485">ID</td> <td data-bbox="794 1350 1005 1485">n/a</td> <td data-bbox="1010 1350 1417 1485">Matched domain 1 is updated.</td> </tr> <tr> <td data-bbox="443 1485 579 1574">5</td> <td data-bbox="584 1485 794 1574">None</td> <td data-bbox="794 1485 1005 1574">n/a</td> <td data-bbox="1010 1485 1417 1574">A new domain is created.</td> </tr> </tbody> </table> <p data-bbox="443 1597 1417 1709">Note Issue domains cannot be migrated</p>	Case	Matched domain 1	Matched domain 2	Result	1	ID and name	n/a	Matched domain 1 is updated.	2	ID	Name and parent community	Matched domain 1 is updated. Matched domain 2 is renamed.	3	Name and parent community	n/a	Matched domain 1 is updated.	4	ID	n/a	Matched domain 1 is updated.	5	None	n/a	A new domain is created.
Case	Matched domain 1	Matched domain 2	Result																						
1	ID and name	n/a	Matched domain 1 is updated.																						
2	ID	Name and parent community	Matched domain 1 is updated. Matched domain 2 is renamed.																						
3	Name and parent community	n/a	Matched domain 1 is updated.																						
4	ID	n/a	Matched domain 1 is updated.																						
5	None	n/a	A new domain is created.																						

Object	Import logic																								
Domain type	<p data-bbox="440 338 794 376">Matching logic based on:</p> <ol data-bbox="440 412 663 539" style="list-style-type: none"> <li data-bbox="440 412 663 450">1. ID and name <li data-bbox="440 456 568 495">2. Name <li data-bbox="440 501 512 539">3. ID <p data-bbox="440 575 1273 613">The following table contains the possible cases and results.</p> <table border="1" data-bbox="440 640 1414 1621"> <thead> <tr> <th data-bbox="440 640 579 824">Case</th> <th data-bbox="584 640 770 824">Matched domain type 1</th> <th data-bbox="775 640 962 824">Matched domain type 2</th> <th data-bbox="967 640 1414 824">Result</th> </tr> </thead> <tbody> <tr> <td data-bbox="440 831 579 958">1</td> <td data-bbox="584 831 770 958">ID and name</td> <td data-bbox="775 831 962 958">n/a</td> <td data-bbox="967 831 1414 958">Matched domain type 1 is updated.</td> </tr> <tr> <td data-bbox="440 965 579 1216">2</td> <td data-bbox="584 965 770 1216">ID</td> <td data-bbox="775 965 962 1216">Name</td> <td data-bbox="967 965 1414 1216">Matched domain type 1 is updated. Matched domain type 2 is renamed.</td> </tr> <tr> <td data-bbox="440 1223 579 1350">3</td> <td data-bbox="584 1223 770 1350">Name</td> <td data-bbox="775 1223 962 1350">n/a</td> <td data-bbox="967 1223 1414 1350">Matched domain type 1 is updated.</td> </tr> <tr> <td data-bbox="440 1357 579 1485">4</td> <td data-bbox="584 1357 770 1485">ID</td> <td data-bbox="775 1357 962 1485">n/a</td> <td data-bbox="967 1357 1414 1485">Matched domain type 1 is updated.</td> </tr> <tr> <td data-bbox="440 1491 579 1619">5</td> <td data-bbox="584 1491 770 1619">None</td> <td data-bbox="775 1491 962 1619">n/a</td> <td data-bbox="967 1491 1414 1619">A new domain type is created.</td> </tr> </tbody> </table> <p data-bbox="491 1682 1342 1720">Note Domain types are imported using the depth-first order.</p>	Case	Matched domain type 1	Matched domain type 2	Result	1	ID and name	n/a	Matched domain type 1 is updated.	2	ID	Name	Matched domain type 1 is updated. Matched domain type 2 is renamed.	3	Name	n/a	Matched domain type 1 is updated.	4	ID	n/a	Matched domain type 1 is updated.	5	None	n/a	A new domain type is created.
Case	Matched domain type 1	Matched domain type 2	Result																						
1	ID and name	n/a	Matched domain type 1 is updated.																						
2	ID	Name	Matched domain type 1 is updated. Matched domain type 2 is renamed.																						
3	Name	n/a	Matched domain type 1 is updated.																						
4	ID	n/a	Matched domain type 1 is updated.																						
5	None	n/a	A new domain type is created.																						

Object	Import logic																				
Relation type	<p>Matching logic based on:</p> <ol style="list-style-type: none"> 1. ID, source asset type and target asset type 2. Source asset type, target asset type, role and co-role <p>The following table contains the possible cases and results.</p> <table border="1" data-bbox="443 595 1414 1798"> <thead> <tr> <th data-bbox="443 595 579 779">Case</th> <th data-bbox="579 595 772 779">Matched relation type 1</th> <th data-bbox="772 595 965 779">Matched relation type 2</th> <th data-bbox="965 595 1414 779">Result</th> </tr> </thead> <tbody> <tr> <td data-bbox="443 779 579 1010">1</td> <td data-bbox="579 779 772 1010">ID, source asset type and target asset type</td> <td data-bbox="772 779 965 1010">n/a</td> <td data-bbox="965 779 1414 1010">Matched relation type 1 is updated.</td> </tr> <tr> <td data-bbox="443 1010 579 1339">2</td> <td data-bbox="579 1010 772 1339">ID</td> <td data-bbox="772 1010 965 1339">Source asset type, target asset type, role and co-role</td> <td data-bbox="965 1010 1414 1339">Matched relation type 2 is updated.</td> </tr> <tr> <td data-bbox="443 1339 579 1668">3</td> <td data-bbox="579 1339 772 1668">Source asset type, target asset type, role and co-role</td> <td data-bbox="772 1339 965 1668">n/a</td> <td data-bbox="965 1339 1414 1668">Matched relation type 1 is updated.</td> </tr> <tr> <td data-bbox="443 1668 579 1798">4</td> <td data-bbox="579 1668 772 1798">None</td> <td data-bbox="772 1668 965 1798">n/a</td> <td data-bbox="965 1668 1414 1798">A new relation type is created.</td> </tr> </tbody> </table>	Case	Matched relation type 1	Matched relation type 2	Result	1	ID, source asset type and target asset type	n/a	Matched relation type 1 is updated.	2	ID	Source asset type, target asset type, role and co-role	Matched relation type 2 is updated.	3	Source asset type, target asset type, role and co-role	n/a	Matched relation type 1 is updated.	4	None	n/a	A new relation type is created.
Case	Matched relation type 1	Matched relation type 2	Result																		
1	ID, source asset type and target asset type	n/a	Matched relation type 1 is updated.																		
2	ID	Source asset type, target asset type, role and co-role	Matched relation type 2 is updated.																		
3	Source asset type, target asset type, role and co-role	n/a	Matched relation type 1 is updated.																		
4	None	n/a	A new relation type is created.																		

Object	Import logic																								
Roles	<p data-bbox="440 338 794 371">Matching logic based on:</p> <ol data-bbox="440 412 663 533" style="list-style-type: none"> <li data-bbox="440 412 663 445">1. ID and name <li data-bbox="440 456 568 490">2. Name <li data-bbox="440 501 512 533">3. ID <p data-bbox="440 573 1273 607">The following table contains the possible cases and results.</p> <table border="1" data-bbox="440 640 1414 1335"> <thead> <tr> <th data-bbox="440 640 576 775">Case</th> <th data-bbox="580 640 767 775">Matched role 1</th> <th data-bbox="772 640 959 775">Matched role 2</th> <th data-bbox="963 640 1414 775">Result</th> </tr> </thead> <tbody> <tr> <td data-bbox="440 781 576 909">1</td> <td data-bbox="580 781 767 909">ID and name</td> <td data-bbox="772 781 959 909">n/a</td> <td data-bbox="963 781 1414 909">Matched role 1 is updated.</td> </tr> <tr> <td data-bbox="440 916 576 1066">2</td> <td data-bbox="580 916 767 1066">ID</td> <td data-bbox="772 916 959 1066">Name</td> <td data-bbox="963 916 1414 1066">Matched role 1 is updated. Matched role 2 is renamed.</td> </tr> <tr> <td data-bbox="440 1072 576 1155">3</td> <td data-bbox="580 1072 767 1155">Name</td> <td data-bbox="772 1072 959 1155">n/a</td> <td data-bbox="963 1072 1414 1155">Matched role 1 is updated.</td> </tr> <tr> <td data-bbox="440 1162 576 1245">4</td> <td data-bbox="580 1162 767 1245">ID</td> <td data-bbox="772 1162 959 1245">n/a</td> <td data-bbox="963 1162 1414 1245">Matched role 1 is updated.</td> </tr> <tr> <td data-bbox="440 1252 576 1335">5</td> <td data-bbox="580 1252 767 1335">None</td> <td data-bbox="772 1252 959 1335">n/a</td> <td data-bbox="963 1252 1414 1335">A new role is created.</td> </tr> </tbody> </table>	Case	Matched role 1	Matched role 2	Result	1	ID and name	n/a	Matched role 1 is updated.	2	ID	Name	Matched role 1 is updated. Matched role 2 is renamed.	3	Name	n/a	Matched role 1 is updated.	4	ID	n/a	Matched role 1 is updated.	5	None	n/a	A new role is created.
Case	Matched role 1	Matched role 2	Result																						
1	ID and name	n/a	Matched role 1 is updated.																						
2	ID	Name	Matched role 1 is updated. Matched role 2 is renamed.																						
3	Name	n/a	Matched role 1 is updated.																						
4	ID	n/a	Matched role 1 is updated.																						
5	None	n/a	A new role is created.																						

Object	Import logic																								
Scope	<p data-bbox="440 338 794 376">Matching logic based on:</p> <ol data-bbox="440 412 663 539" style="list-style-type: none"> <li data-bbox="440 412 663 450">1. ID and name <li data-bbox="440 456 568 495">2. Name <li data-bbox="440 501 512 539">3. ID <p data-bbox="440 575 1273 613">The following table contains the possible cases and results.</p> <table border="1" data-bbox="440 642 1414 1335"> <thead> <tr> <th data-bbox="440 642 576 779">Case</th> <th data-bbox="580 642 767 779">Matched scope 1</th> <th data-bbox="772 642 959 779">Matched scope 2</th> <th data-bbox="963 642 1414 779">Result</th> </tr> </thead> <tbody> <tr> <td data-bbox="440 779 576 913">1</td> <td data-bbox="580 779 767 913">ID and name</td> <td data-bbox="772 779 959 913">n/a</td> <td data-bbox="963 779 1414 913">Matched scope 1 is updated.</td> </tr> <tr> <td data-bbox="440 913 576 1070">2</td> <td data-bbox="580 913 767 1070">ID</td> <td data-bbox="772 913 959 1070">Name</td> <td data-bbox="963 913 1414 1070">Matched scope 1 is updated. Matched scope 2 is renamed.</td> </tr> <tr> <td data-bbox="440 1070 576 1160">3</td> <td data-bbox="580 1070 767 1160">Name</td> <td data-bbox="772 1070 959 1160">n/a</td> <td data-bbox="963 1070 1414 1160">Matched scope 1 is updated.</td> </tr> <tr> <td data-bbox="440 1160 576 1249">4</td> <td data-bbox="580 1160 767 1249">ID</td> <td data-bbox="772 1160 959 1249">n/a</td> <td data-bbox="963 1160 1414 1249">Matched scope 1 is updated.</td> </tr> <tr> <td data-bbox="440 1249 576 1335">5</td> <td data-bbox="580 1249 767 1335">None</td> <td data-bbox="772 1249 959 1335">n/a</td> <td data-bbox="963 1249 1414 1335">A new scope is created.</td> </tr> </tbody> </table> <p data-bbox="491 1395 1114 1433">Note The global scope cannot be migrated.</p>	Case	Matched scope 1	Matched scope 2	Result	1	ID and name	n/a	Matched scope 1 is updated.	2	ID	Name	Matched scope 1 is updated. Matched scope 2 is renamed.	3	Name	n/a	Matched scope 1 is updated.	4	ID	n/a	Matched scope 1 is updated.	5	None	n/a	A new scope is created.
Case	Matched scope 1	Matched scope 2	Result																						
1	ID and name	n/a	Matched scope 1 is updated.																						
2	ID	Name	Matched scope 1 is updated. Matched scope 2 is renamed.																						
3	Name	n/a	Matched scope 1 is updated.																						
4	ID	n/a	Matched scope 1 is updated.																						
5	None	n/a	A new scope is created.																						

Object	Import logic																								
Status	<p data-bbox="440 338 794 376">Matching logic based on:</p> <ol data-bbox="440 412 663 539" style="list-style-type: none"> <li data-bbox="440 412 663 450">1. ID and name <li data-bbox="440 456 568 495">2. Name <li data-bbox="440 501 512 539">3. ID <p data-bbox="440 575 1273 613">The following table contains the possible cases and results.</p> <table border="1" data-bbox="440 642 1414 1335"> <thead> <tr> <th data-bbox="440 642 576 779">Case</th> <th data-bbox="580 642 767 779">Matched status 1</th> <th data-bbox="772 642 959 779">Matched status 2</th> <th data-bbox="963 642 1414 779">Result</th> </tr> </thead> <tbody> <tr> <td data-bbox="440 786 576 913">1</td> <td data-bbox="580 786 767 913">ID and name</td> <td data-bbox="772 786 959 913">n/a</td> <td data-bbox="963 786 1414 913">Matched status 1 is updated.</td> </tr> <tr> <td data-bbox="440 920 576 1070">2</td> <td data-bbox="580 920 767 1070">ID</td> <td data-bbox="772 920 959 1070">Name</td> <td data-bbox="963 920 1414 1070">Matched status 1 is updated. Matched status 2 is renamed.</td> </tr> <tr> <td data-bbox="440 1077 576 1160">3</td> <td data-bbox="580 1077 767 1160">Name</td> <td data-bbox="772 1077 959 1160">n/a</td> <td data-bbox="963 1077 1414 1160">Matched status 1 is updated.</td> </tr> <tr> <td data-bbox="440 1167 576 1249">4</td> <td data-bbox="580 1167 767 1249">ID</td> <td data-bbox="772 1167 959 1249">n/a</td> <td data-bbox="963 1167 1414 1249">Matched status 1 is updated.</td> </tr> <tr> <td data-bbox="440 1256 576 1339">5</td> <td data-bbox="580 1256 767 1339">None</td> <td data-bbox="772 1256 959 1339">n/a</td> <td data-bbox="963 1256 1414 1339">A new status is created.</td> </tr> </tbody> </table>	Case	Matched status 1	Matched status 2	Result	1	ID and name	n/a	Matched status 1 is updated.	2	ID	Name	Matched status 1 is updated. Matched status 2 is renamed.	3	Name	n/a	Matched status 1 is updated.	4	ID	n/a	Matched status 1 is updated.	5	None	n/a	A new status is created.
Case	Matched status 1	Matched status 2	Result																						
1	ID and name	n/a	Matched status 1 is updated.																						
2	ID	Name	Matched status 1 is updated. Matched status 2 is renamed.																						
3	Name	n/a	Matched status 1 is updated.																						
4	ID	n/a	Matched status 1 is updated.																						
5	None	n/a	A new status is created.																						

Object	Import logic																
Validation rule	<p data-bbox="443 338 794 376">Matching logic based on:</p> <ol data-bbox="443 412 895 495" style="list-style-type: none"> <li data-bbox="443 412 512 450">1. ID <li data-bbox="443 456 895 495">2. Full name and parent domain <p data-bbox="443 530 1273 568">The following table contains the possible cases and results.</p> <table border="1" data-bbox="443 595 1414 1234"> <thead> <tr> <th data-bbox="451 607 576 779">Case</th> <th data-bbox="584 607 778 779">Matched validation rule 1</th> <th data-bbox="786 607 981 779">Matched validation rule 2</th> <th data-bbox="989 607 1406 779">Result</th> </tr> </thead> <tbody> <tr> <td data-bbox="451 790 576 913">1</td> <td data-bbox="584 790 778 913">ID</td> <td data-bbox="786 790 981 913">n/a</td> <td data-bbox="989 790 1406 913">Matched validation rule 1 is updated.</td> </tr> <tr> <td data-bbox="451 925 576 1093">2</td> <td data-bbox="584 925 778 1093">Full name and parent domain</td> <td data-bbox="786 925 981 1093">n/a</td> <td data-bbox="989 925 1406 1093">Matched validation rule 1 is updated.</td> </tr> <tr> <td data-bbox="451 1104 576 1227">3</td> <td data-bbox="584 1104 778 1227">None</td> <td data-bbox="786 1104 981 1227">n/a</td> <td data-bbox="989 1104 1406 1227">A new validation rule is created.</td> </tr> </tbody> </table> <p data-bbox="491 1294 1337 1377">Note If there is a match, only the Description and Validation script are changed. Other characteristics are not changed.</p>	Case	Matched validation rule 1	Matched validation rule 2	Result	1	ID	n/a	Matched validation rule 1 is updated.	2	Full name and parent domain	n/a	Matched validation rule 1 is updated.	3	None	n/a	A new validation rule is created.
Case	Matched validation rule 1	Matched validation rule 2	Result														
1	ID	n/a	Matched validation rule 1 is updated.														
2	Full name and parent domain	n/a	Matched validation rule 1 is updated.														
3	None	n/a	A new validation rule is created.														

Object	Import logic																
Workflow	<p>Matching logic based on:</p> <ol style="list-style-type: none"> 1. Workflow process ID 2. Workflow name <p>The following table contains the possible cases and results.</p> <table border="1" data-bbox="443 595 1414 1350"> <thead> <tr> <th data-bbox="451 604 576 730">Case</th> <th data-bbox="584 604 770 730">Matched workflow 1</th> <th data-bbox="778 604 965 730">Matched workflow 2</th> <th data-bbox="973 604 1406 730">Result</th> </tr> </thead> <tbody> <tr> <td data-bbox="451 741 576 958">1</td> <td data-bbox="584 741 770 958">Process ID and workflow name</td> <td data-bbox="778 741 965 958">n/a</td> <td data-bbox="973 741 1406 958">Matched workflow 1 is updated.</td> </tr> <tr> <td data-bbox="451 969 576 1261">2</td> <td data-bbox="584 969 770 1261">Process ID</td> <td data-bbox="778 969 965 1261">Workflow name</td> <td data-bbox="973 969 1406 1261"> Matched workflow 1 is updated. Matched workflow 2 is renamed with a suffix of - \$processId. </td> </tr> <tr> <td data-bbox="451 1272 576 1350">3</td> <td data-bbox="584 1272 770 1350">None</td> <td data-bbox="778 1272 965 1350">n/a</td> <td data-bbox="973 1272 1406 1350">A new workflow is created.</td> </tr> </tbody> </table>	Case	Matched workflow 1	Matched workflow 2	Result	1	Process ID and workflow name	n/a	Matched workflow 1 is updated.	2	Process ID	Workflow name	Matched workflow 1 is updated. Matched workflow 2 is renamed with a suffix of - \$processId.	3	None	n/a	A new workflow is created.
Case	Matched workflow 1	Matched workflow 2	Result														
1	Process ID and workflow name	n/a	Matched workflow 1 is updated.														
2	Process ID	Workflow name	Matched workflow 1 is updated. Matched workflow 2 is renamed with a suffix of - \$processId.														
3	None	n/a	A new workflow is created.														
Navigation objects																	

Object	Import logic																
Table view	<p data-bbox="443 338 794 371">Matching logic based on:</p> <ol data-bbox="443 412 1249 495" style="list-style-type: none"> <li data-bbox="443 412 512 445">1. ID <li data-bbox="443 456 1249 495">2. Name, type, location and common assigned resources <p data-bbox="443 528 1273 562">The following table contains the possible cases and results.</p> <table border="1" data-bbox="443 595 1412 1373"> <thead> <tr> <th data-bbox="451 607 576 779">Case</th> <th data-bbox="584 607 770 779">Matched table view 1</th> <th data-bbox="778 607 965 779">Matched table view 2</th> <th data-bbox="973 607 1404 779">Result</th> </tr> </thead> <tbody> <tr> <td data-bbox="451 790 576 913">1</td> <td data-bbox="584 790 770 913">ID</td> <td data-bbox="778 790 965 913">n/a</td> <td data-bbox="973 790 1404 913">Matched table view 1 is updated.</td> </tr> <tr> <td data-bbox="451 925 576 1283">2</td> <td data-bbox="584 925 770 1283">Name, type, location and at least 1 common assigned resource</td> <td data-bbox="778 925 965 1283">n/a</td> <td data-bbox="973 925 1404 1283">Matched table view 1 is updated.</td> </tr> <tr> <td data-bbox="451 1294 576 1373">3</td> <td data-bbox="584 1294 770 1373">None</td> <td data-bbox="778 1294 965 1373">n/a</td> <td data-bbox="973 1294 1404 1373">A new table view is created.</td> </tr> </tbody> </table>	Case	Matched table view 1	Matched table view 2	Result	1	ID	n/a	Matched table view 1 is updated.	2	Name, type, location and at least 1 common assigned resource	n/a	Matched table view 1 is updated.	3	None	n/a	A new table view is created.
Case	Matched table view 1	Matched table view 2	Result														
1	ID	n/a	Matched table view 1 is updated.														
2	Name, type, location and at least 1 common assigned resource	n/a	Matched table view 1 is updated.														
3	None	n/a	A new table view is created.														

Object	Import logic																
Dashboard	<p data-bbox="443 338 794 376">Matching logic based on:</p> <ol data-bbox="443 412 1249 495" style="list-style-type: none"> <li data-bbox="443 412 512 450">1. ID <li data-bbox="443 456 1249 495">2. Name, type, location and common assigned resources <p data-bbox="443 530 1273 568">The following table contains the possible cases and results.</p> <table border="1" data-bbox="443 595 1417 1328"> <thead> <tr> <th data-bbox="451 607 579 730">Case</th> <th data-bbox="587 607 794 730">Matched dashboard 1</th> <th data-bbox="802 607 1010 730">Matched dashboard 2</th> <th data-bbox="1018 607 1409 730">Result</th> </tr> </thead> <tbody> <tr> <td data-bbox="451 741 579 864">1</td> <td data-bbox="587 741 794 864">ID</td> <td data-bbox="802 741 1010 864">n/a</td> <td data-bbox="1018 741 1409 864">Matched dashboard 1 is updated.</td> </tr> <tr> <td data-bbox="451 875 579 1193">2</td> <td data-bbox="587 875 794 1193">Name, type, location and at least 1 common assigned resource</td> <td data-bbox="802 875 1010 1193">n/a</td> <td data-bbox="1018 875 1409 1193">Matched dashboard 1 is updated.</td> </tr> <tr> <td data-bbox="451 1205 579 1328">3</td> <td data-bbox="587 1205 794 1328">None</td> <td data-bbox="802 1205 1010 1328">n/a</td> <td data-bbox="1018 1205 1409 1328">A new dashboard is created.</td> </tr> </tbody> </table>	Case	Matched dashboard 1	Matched dashboard 2	Result	1	ID	n/a	Matched dashboard 1 is updated.	2	Name, type, location and at least 1 common assigned resource	n/a	Matched dashboard 1 is updated.	3	None	n/a	A new dashboard is created.
Case	Matched dashboard 1	Matched dashboard 2	Result														
1	ID	n/a	Matched dashboard 1 is updated.														
2	Name, type, location and at least 1 common assigned resource	n/a	Matched dashboard 1 is updated.														
3	None	n/a	A new dashboard is created.														

Object	Import logic																
Diagram view	<p data-bbox="438 338 794 376">Matching logic based on:</p> <ol data-bbox="438 412 1249 495" style="list-style-type: none"> <li data-bbox="438 412 512 450">1. ID <li data-bbox="438 456 1249 495">2. Name, type, location and common assigned resources <p data-bbox="438 530 1275 568">The following table contains the possible cases and results.</p> <table border="1" data-bbox="443 595 1417 1424"> <thead> <tr> <th data-bbox="443 595 579 779">Case</th> <th data-bbox="579 595 772 779">Matched diagram view 1</th> <th data-bbox="772 595 965 779">Matched diagram view 2</th> <th data-bbox="965 595 1417 779">Result</th> </tr> </thead> <tbody> <tr> <td data-bbox="443 779 579 913">1</td> <td data-bbox="579 779 772 913">ID</td> <td data-bbox="772 779 965 913">n/a</td> <td data-bbox="965 779 1417 913">Matched diagram view 1 is updated.</td> </tr> <tr> <td data-bbox="443 913 579 1290">2</td> <td data-bbox="579 913 772 1290">Name, type, location and at least 1 common assigned resource</td> <td data-bbox="772 913 965 1290">n/a</td> <td data-bbox="965 913 1417 1290">Matched diagram view 1 is updated.</td> </tr> <tr> <td data-bbox="443 1290 579 1424">3</td> <td data-bbox="579 1290 772 1424">None</td> <td data-bbox="772 1290 965 1424">n/a</td> <td data-bbox="965 1290 1417 1424">A new diagram view is created.</td> </tr> </tbody> </table>	Case	Matched diagram view 1	Matched diagram view 2	Result	1	ID	n/a	Matched diagram view 1 is updated.	2	Name, type, location and at least 1 common assigned resource	n/a	Matched diagram view 1 is updated.	3	None	n/a	A new diagram view is created.
Case	Matched diagram view 1	Matched diagram view 2	Result														
1	ID	n/a	Matched diagram view 1 is updated.														
2	Name, type, location and at least 1 common assigned resource	n/a	Matched diagram view 1 is updated.														
3	None	n/a	A new diagram view is created.														

Object	Import logic																
Search filter	<p>Matching logic based on:</p> <ol style="list-style-type: none"> 1. ID 2. Name, type, location and common assigned resources <p>The following table contains the possible cases and results.</p> <table border="1"> <thead> <tr> <th>Case</th> <th>Matched search filter 1</th> <th>Matched search filter 2</th> <th>Result</th> </tr> </thead> <tbody> <tr> <td>1</td> <td>ID</td> <td>n/a</td> <td>Matched search filter 1 is updated.</td> </tr> <tr> <td>2</td> <td>Name, type, location and at least 1 common assigned resource</td> <td>n/a</td> <td>Matched search filter 1 is updated.</td> </tr> <tr> <td>3</td> <td>None</td> <td>n/a</td> <td>A new search filter is created.</td> </tr> </tbody> </table>	Case	Matched search filter 1	Matched search filter 2	Result	1	ID	n/a	Matched search filter 1 is updated.	2	Name, type, location and at least 1 common assigned resource	n/a	Matched search filter 1 is updated.	3	None	n/a	A new search filter is created.
Case	Matched search filter 1	Matched search filter 2	Result														
1	ID	n/a	Matched search filter 1 is updated.														
2	Name, type, location and at least 1 common assigned resource	n/a	Matched search filter 1 is updated.														
3	None	n/a	A new search filter is created.														

Migration import troubleshooting

In some very specific situations, the [Migration feature](#) has some limitations which may lead to undesired effects. This topic describes a situation in which objects seem to disappear during the import.

Import logic

For each object in the migration file, the Migration feature tries to find a match in the target environment. First, it looks for objects of the same object type and with the same ID. If no

matches are found, it looks for objects of the same object type with the same logical key. For most objects, this is the name. For more information about the import logic see [Migration import logic](#).

Summary

The same object exists in your source and target environment. You renamed the object in your source environment, and created an object of the same type and gave it the original name of the first object. This may cause the import feature to overwrite the first object when importing in the target environment.

Detailed explanation

1. In the beginning, the source and the target environment are the same.
2. You edit the name of an existing source object, and optionally other properties.
 - » This has no effect on the ID of the first source object.
3. You create an object of the same type and gave it the original name of the first object.
4. You export both source objects to a migration file.
5. You import the migration file in the target environment.
 - » When importing the migration file in the target environment, two scenarios can take place.

Scenario 1: The older object is processed first.

- a. The import logic looks for the first target object based on the ID.
 - » The import logic finds the first target object.
- b. The import logic overwrites the first target object with the first source object.
 - » This does not affect the ID, but it does change the name of the first target object.
- c. The import logic looks for the second object based on the ID.
 - » The import logic does not find the second target object.
- d. The import logic looks for an object based on the name.
 - » The import logic does not find the second target object.
- e. The import logic creates a new object with the properties of the second source object, including its name.
- f. The two objects in the two environments are identical.

Scenario 2: The newer object is processed first.

- a. The import logic looks for the second target object based on the ID.
 - » The import logic does not find a target object.
- b. The import logic looks for the second object based on the name.
 - » The import logic finds the target object of the first source object.
- c. The import logic overwrites the first source object with the second target object.
 - » This has no effect on the ID.
- d. The import logic looks for the first target object based on the ID.
 - » The import logic finds the first target object, which was overwritten by the second source object.
- e. The import logic overwrites the first source object again, this time with the first target object.
 - » This does not affect the ID, but it does change the name of the first target object.
- f. The second target object does not exist in the target environment.

Replace the Collibra logo

By default, Collibra Data Governance Center has the Collibra logo on the sign-in page and in the top-left corner.

You can use your own images:

- As the logo in the upper-left corner.
- On the sign-in page and while opening Collibra DGC.

Prerequisites

- You need a user with the SUPER role in Collibra Console.
- You need knowledge of the JSON syntax.
- You need images with the following properties:
 - The recommended image format is SVG, but JPG and PNG are also supported.
 - The dimensions of the image on the sign-in page must be 310 x 85 px (w x h).
 - The dimensions of the logo in Collibra DGC must be 50 x 45 px (w x h).

- If the custom image is larger, it will be resized to the mentioned dimensions, so make sure that the custom logo has the same width/height ratio.

Important Contact [Collibra support](#) after completing step 1 below If you are changing the logo for a Collibra Data Intelligence Cloud environment. For an on-premises Collibra environment, you can change the logo all by yourself.

Steps

1. Add your images to the Collibra DGC folder structure:
 - a. **Create** a backup of your cloud environment that only includes the customizations and configuration.
 - b. **Download** the backup.
 - » A ZIP file is downloaded to your hard disk.
 - c. Edit the backup:
 - i. Extract the ZIP file on your local computer.
 - » A folder with the name of the ZIP file is created.
 - ii. In the created folder structure, go to **<backup-dir>/dgc/images**.

Note If any of these folders do not exist, create them.
 - iii. Copy your images to this folder.
 - iv. In your file browser, open the extracted backup folder with the new logos.
 - v. Create a ZIP file of all the contents in this folder.

Warning Do not create a ZIP file from the extracted directory itself. Doing so will result in an invalid backup file.
 - d. Restore the new backup file:
 - i. Open Collibra Console with a user profile that has at least the **ADMIN** role.
 - » Collibra Console opens with the **Infrastructure** page.
 - ii. **Upload** the new ZIP file to Collibra Console.
 - iii. **Restore** the customizations and configuration of the new ZIP file.
 - iv. Wait until your environment is up and running again.
2. In the tab pane, click the Data Governance Center service of your environment.

3. Click **Configuration**.
4. Click **Edit configuration**.
5. Go to the section **User interface configuration**.
6. In the **Page definition overrides** field, copy the following lines and paste them between the curly brackets:

```
"all": {  
  "headerLogo": "/resources/images/<image for the top-left  
corner>" ,  
  "signinLogo": "/resources/images/<image for the sign-in  
page>"  
}
```

Note

- If there is already content in this field, make sure that you add these lines as new key-value pair.
- You don't have to use both images. If you only want to change the image on the sign-in page, omit the `headerLogo` line and vice versa.
- If you want to use a publicly available image that is not stored in the Collibra DGC folder structure, replace the path to the image by the public URL.

7. Click **Save all**.

What's next?

Sign in to Collibra DGC to see the new images. If you signed in before, you may have to clear your browser cache.

Tip You can also **change** the loading message by editing the `ui.core.loadingapplication` key of the interface text.

Use a custom favicon

By default, Collibra Data Governance Center has the Collibra logo as favicon.

This article describes how you can use your own favicon.

Note This procedure is applicable for on-premises and cloud environments.

Prerequisites

- Your favicon has the name **favicon.ico**.

Steps

1. **Create** a backup of your cloud environment that only includes the customizations and configuration.
2. **Download** the backup.
3. Extract the backup somewhere on your local computer.
4. In the created folder structure, go to **<backup-dir>/dgc/images/icons**.

Note If any of these folders do not exist, create them.

5. Copy your **favicon.ico** in this folder.
6. Create a ZIP file of all the content inside the backup folder.
Do not create a ZIP file from the extracted directory itself, this would result in an invalid backup file.
7. **Upload** the new ZIP file to Collibra Console.
8. **Restore** only the customizations and configuration of the new ZIP file.
9. Wait until your environment is up and running again.
10. Clear the cache of your browser and go to your environment.
 - » Your own favicon will appear.